

21
10-1

ARMY FM 10-500-3
AIR FORCE TO 13C7-1-11
MARINE CORPS FMFM 7-47

MCRP 4-11.3C (formerly )



AIRDROP OF SUPPLIES AND EQUIPMENT **RIGGING CONTAINERS**

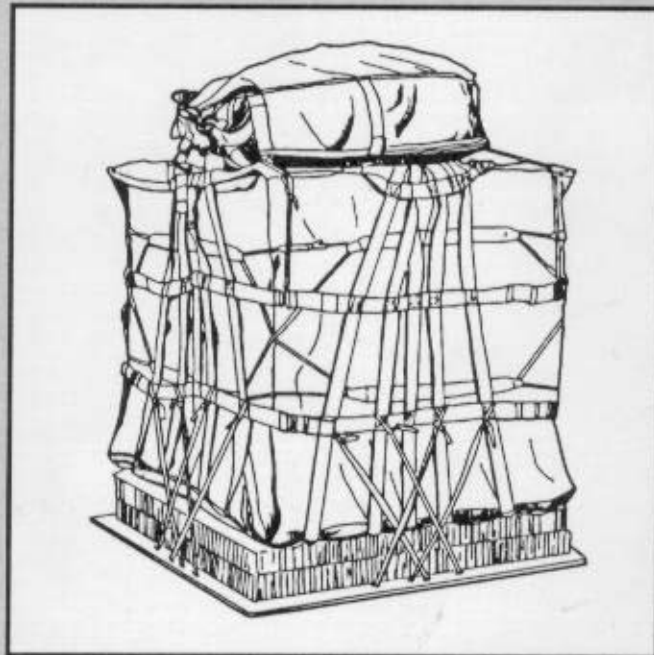

DISTRIBUTION UNLIMITED

HEADQUARTERS
DEPARTMENTS OF THE ARMY AND THE AIR FORCE
THE US MARINE CORPS

MCCDC (C 42)
27 Nov 2002

E R R A T U M

to

MCRP 4-11.3C

AIRDROP OF SUPPLIES AND EQUIPMENT: RIGGING CONTAINERS

1. For administrative purposes, FMFM 7-47 is reidentified as MCRP 4-11.3C.

144 000130 80



REPLY TO
ATTENTION OF

DEPARTMENT OF THE ARMY
AERIAL DELIVERY AND FIELD SERVICES DEPARTMENT
U.S. ARMY QUARTERMASTER CENTER AND SCHOOL
1010 SHOP ROAD
FORT LEE, VIRGINIA 23801-1502

ATSM-ADFSD

7 October 1998

MEMORANDUM FOR Commander, US Army Training Support Center, ATTN: ATIC-TIST (Mr. Baston), Fort Eustis, VA 23604

SUBJECT: Distribution Restriction Notice on Airdrop Rigging Manuals

1. As proponent for development of all 10-500 series airdrop rigging field manuals and the 10-450 sling load manuals, it has been determined that the distribution restriction on these field manuals should be changed to read: Approved for public release, distribution unlimited.
2. It is requested that unrestricted release of these field manuals be made via the Army Training Digital Library.
3. The new distribution notice will be added to the cover pages as future changes/revisions are made to the manuals.
4. Enclosed you will find a numerical list and the number of changes of the manuals that have unlimited distribution.
5. The point of contact for this action is Mr. Roger Hale, DSN 687-4769.

Encl

THEODORE J. DLUGOS
Director, Aerial Delivery and
Field Services Department

Distribution restrictions for the following Airdrop field manuals should read "**Approved for public release; distribution is unlimited.**"

10-450-3	10-524, c2	10-552, c2
10-450-4	10-526, c3	10-554
10-500-2, c2	10-527, c3	10-555, c2
10-500-3, c1	10-528, c6	10-556
10-500-7, c1	10-529, c1	10-557
10-500-45	10-530	10-558, c1
10-500-53	10-531, c2	10-562
10-500-66, c1	10-532, c4	10-564, c6
10-500-71	10-533	10-567, c1
10-508, c1	10-534, c2	10-569, c1
10-510, c3	10-535	10-571
10-512, c4	10-537, c4	10-572
10-513, c3	10-539, c3	10-573, c1
10-515, c1	10-540, c2	10-574, c4
10-516	10-541, c1	10-575, c2
10-517, c5	10-542, c2	10-576, c1
10-518	10-543, c2	10-577
10-519, c3	10-546	10-579, c2
10-520, c3	10-547, c1	10-584
10-521, c2	10-548, c1	10-586
10-522, c1	10-549	10-588
10-523, c2	10-550, c3	10-591, c1

CHANGE
No. 1

HEADQUARTERS
DEPARTMENT OF THE ARMY
UNITED STATES MARINE CORPS
DEPARTMENT OF THE AIR FORCE
Washington, DC, 26 September 1996

**AIRDROP OF SUPPLIES AND EQUIPMENT:
RIGGING CONTAINERS**

This change updates various technical information concerning the rigging of airdrop containers and provides specific information on rigging of loads for C-17 aircraft. Also with this change, there are procedures for rigging the stretch A-22 cargo bag and for modifying the T-10 parachute for cargo airdrop.

FM 10-500-3, 8 December 1992, is changed as follows:

1. New or changed material is identified by a vertical bar in the margin opposite the changed material.
2. File this transmittal sheet in front of publication for reference purposes.
3. Remove old pages and insert new pages as indicated below:

Remove old pages

Insert new pages

i through ix.....	i through ix
1-1 through 1-6.....	1-1 through 1-6
2-1 through 2-3.....	2-1 through 2-5
3-1 and 3-2.....	3-1 and 3-2
3-9 and 3-10.....	3-9 and 3-10
	3-19 through 3-25
4-5 through 4-8.....	4-5 through 4-8
4-13 and 4-14.....	4-13 and 4-14
4-17 and 4-18.....	4-17 and 4-18
4-25 and 4-26.....	4-25 and 4-26
5-1 and 5-2.....	5-1 and 5-2
6-5 and 6-6.....	6-5 and 6-6
6-9 and 6-10.....	6-9 and 6-10
6-13 and 6-14.....	6-13 and 6-14
6-17 and 6-18.....	6-17 and 6-18
7-1 and 7-2.....	7-1 and 7-2
7-9 and 7-10.....	7-9 and 7-10
7-21 and 7-22.....	7-21 and 7-22
8-1 through 8-4.....	8-1 through 8-4
8-7 and 8-8.....	8-7 and 8-8

DISTRIBUTION RESTRICTION: Distribution authorized to US Government agencies only to protect technical or operational information from automatic dissemination under the International Exchange Program or by other means. This determination was made on 30 April 1993. Other requests for this document will be referred to Airborne and Field Services Department, USA Quartermaster Center and School, 1010 Shop Road, Fort Lee, VA 23801-1502.

DESTRUCTION NOTICE: Destroy by any method that will prevent disclosure of contents or reconstruction of the document..

Remove old pages

Insert new pages

8-11 and 8-12.....	8-11 and 8-12
8-15 and 8-16	
9-1 through 9-16.....	9-1 through 9-16
9-27 and 9-28.....	9-27 and 9-28
	9-29 through 9-41
10-1 through 10-6.....	10-1 and 10-6
10-17 through 10-20.....	10-17 through 10-20
10-25 and 10-26.....	10-25 and 10-26
11-9 and 11-10.....	11-9 and 11-10
11-13 and 11-14.....	11-13 and 11-14
12-7 through 12-9.....	12-7 through 12-9
Glossary-1	Glossary-1
References-1 and References-2	References-1 and References-2

By Order of the Secretaries of the Army and the Air Force:

Official:

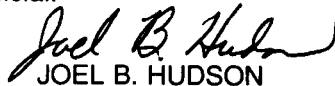

JOEL B. HUDSON

*Administrative Assistant to the
Secretary of the Army*

02384

DENNIS J. REIMER
*General, United States Army
Chief of Staff*

BY DIRECTION OF THE COMMANDANT OF THE MARINE CORPS

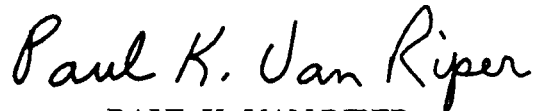

PAUL K. VAN RIPER

Lieutenant General, U.S. Marine Corps
Commanding General

Marine Corps Combat Development Command
Quantico, Virginia

DISTRIBUTION:

Active Army, Army National Guard, and U.S. Army Reserve: To be distributed in accordance with the initial distribution number 110895, requirements for FM 10-500-3.

FIELD MANUAL
No. 10-500-3
FLEET MARINE FORCE MANUAL
No. 7-47
TECHNICAL ORDER
No. 13C7-1-11

HEADQUARTERS
DEPARTMENT OF THE ARMY
UNITED STATES MARINE CORPS
DEPARTMENT OF THE AIR FORCE
Washington, DC, 8 December 1992

AIRDROP OF SUPPLIES AND EQUIPMENT: RIGGING CONTAINERS

TABLE OF CONTENTS

	Paragraph	Page
PREFACE		viii
PART ONE	GENERAL INFORMATION	
CHAPTER 1	GENERAL RIGGING INFORMATION FOR CONTAINER LOADS	
Section I	RIGGING INFORMATION	
Description of Container Loads	1-1	1-1
Types of Airdrop	1-2	1-2
Commonly Used Items	1-3	1-2
Parachute Requirements	1-4	1-3
Data Tag for Rigged Loads	1-5	1-3
Computation of Minimum Weight for Container Loads	1-6	1-4
Special Considerations	1-7	1-4
Safety Precautions	1-8	1-4
Rigging Precautions	1-9	1-4
Loads Dropped in Frigid Climates	1-10	1-5
Final Inspection	1-11	1-5
Release Gate	1-12	1-5
Knots Used	1-13	1-6
Securing of Straps and Webbing	1-14	1-7
Section II	HIGH-ALTITUDE AIRDROP RESUPPLY SYSTEM	
Description of HAARS	1-15	1-9
Altitude Sensor Parachute Staging Unit	1-16	1-9

DISTRIBUTION RESTRICTION: Distribution authorized to US government agencies only to protect technical or operational information from automatic dissemination under the International Exchange Program or by other means. This determination was made on 30 April 1993. Other requests for this document will be referred to Airborne and Field Services Department, USA Quartermaster Center and School, 1010 Shop Road, Fort Lee, VA 23801-1502.

DESTRUCTION NOTICE: Destroy by any method that will prevent disclosure of contents or reconstruction of the document.

*This publication supersedes FM 10-501, 23 May 1989.
MARINE CORPS PCN: 13900073401

	Paragraph	Page
CHAPTER 2	AIRCRAFT INFORMATION	
	Army Aircraft	2-1 2-1
	Air Force Aircraft	2-2 2-2
	CVRS	2-3 2-2
	Inboard Logistics Rail	2-4 2-3
	Release Gate Load Spreader	2-5 2-4
	Capabilities of Non-CVRS Loads	2-6 2-5
PART TWO	RIGGING A-7A CONTAINER LOADS	
CHAPTER 3	GENERAL INFORMATION AND PROCEDURES	
	A-7A Airdrop Cargo Sling Assembly	3-1 3-1
	Weight Limits	3-2 3-2
	A-7A Container Loads	3-3 3-2
	Parachutes for A-7A Loads	3-4 3-2
	Modifying the T-10 Parachute	3-5 3-19
CHAPTER 4	RIGGING TYPICAL A-7A CONTAINERS	
Section I	LOW-VELOCITY AIRDROP FROM PARATROOP DOOR	
	Description of Load	4-1 4-1
	Positioning Straps	4-2 4-1
	Positioning Load and Securing Straps	4-3 4-2
	Installing Parachute	4-4 4-5
	Marking Rigged Load	4-5 4-5
	Equipment Required	4-6 4-5
Section II	LOW-VELOCITY AIRDROP FROM RAMP	
	Description of Load	4-7 4-8
	Preparing Skid Board	4-8 4-8
	Placing Honeycomb and Positioning Straps	4-9 4-8
	Positioning Load and Securing Straps	4-10 4-8
	Securing Skid Board	4-11 4-8
	Installing Parachute	4-12 4-13
	Marking Rigged Load	4-13 4-13
	Equipment Required	4-14 4-13
Section III	HIGH-VELOCITY AIRDROP	
	Description of Load	4-15 4-15
	Preparing Drop Items	4-16 4-15
	Preparing Skid Board	4-17 4-15
	Positioning Straps	4-18 4-15
	Placing Honeycomb	4-19 4-15
	Securing Straps	4-20 4-17
	Securing Skid Board	4-21 4-17
	Installing Parachute	4-22 4-17
	Marking Rigged Load	4-23 4-17
	Equipment Required	4-24 4-17

		Paragraph	Page
Section IV	HAARS		
	Description of Load	4-25	4-20
	Rigging Load	4-26	4-20
	Preparing and Installing Parachute	4-27	4-20
	Installing Altitude Sensor Parachute Staging Unit and Pilot Parachute	4-28	4-20
	Marking Rigged Load	4-29	4-25
	Equipment Required	4-30	4-25
PART THREE RIGGING A-21 CONTAINER LOADS			
CHAPTER 5	GENERAL INFORMATION AND PROCEDURES		
	A-21 Cargo Bag Assembly	5-1	5-1
	Capabilities of A-21 Bag	5-2	5-2
	Parachutes Used for A-21 Containers	5-3	5-2
	Installation of Parachutes on A-21 Containers	5-4	5-2
CHAPTER 6	RIGGING TYPICAL A-21 LOADS		
Section I	LOW-VELOCITY AIRDROP FROM PARATROOP DOOR		
	Description of load	6-1	6-1
	Preparing Drop Items	6-2	6-1
	Positioning Container and Load	6-3	6-1
	Rigging Container	6-4	6-3
	Installing Parachute	6-5	6-5
	Marking Rigged Load	6-6	6-5
	Equipment Required	6-7	6-5
Section II	LOW-VELOCITY AIRDROP FROM RAMP		
	Description of Load	6-8	6-7
	Preparing Drop Items	6-9	6-7
	Preparing Skid Board	6-10	6-7
	Positioning Container and Load	6-11	6-7
	Rigging Container	6-12	6-7
	Securing Skid Board	6-13	6-7
	Installing Parachute	6-14	6-10
	Marking Rigged Load	6-15	6-10
	Equipment Required	6-16	6-10
Section III	HIGH-VELOCITY AIRDROP		
	Description of Load	6-17	6-12
	Preparing Drop Items	6-18	6-12
	Preparing Skid Board	6-19	6-12
	Positioning Honeycomb	6-20	6-12
	Positioning Container and Load	6-21	6-13
	Rigging Container	6-22	6-13
	Securing Skid Board	6-23	6-13

	Paragraph	Page
Installing Parachute	6-24	6-13
Marking Rigged Load	6-25	6-13
Equipment Required	6-26	6-13
Section IV		
HAARS		
Description of Load	6-27	6-16
Rigging Container	6-28	6-16
Preparing and Installing Cargo Parachute	6-29	6-16
Installing Altitude Sensor Parachute Staging Unit and Pilot Parachute	6-30	6-16
Marking Rigged Load	6-31	6-16
Equipment Required	6-32	6-16
CHAPTER 7		
RIGGING SPECIFIC A-21 LOADS		
Section I		
RIGGING GLLD FOR LOW-VELOCITY AIRDROP		
Description of Load	7-1	7-1
Preparing Skid Boards	7-2	7-1
Placing Honeycomb and Top Skid Board	7-3	7-1
Rigging GLLD	7-4	7-1
Installing Parachute	7-5	7-1
Marking Rigged Load	7-6	7-10
Equipment Required	7-7	7-10
Section II		
RIGGING AIR TRAFFIC CONTROL FACILITY AN/TSQ-97A FOR LOW-VELOCITY AIRDROP		
Description of Load	7-8	7-12
Preparing Load	7-9	7-12
Preparing Skid Board	7-10	7-15
Positioning Honeycomb	7-11	7-16
Placing Container	7-12	7-17
Positioning Load	7-13	7-17
Rigging Container	7-14	7-21
Installing Parachute	7-15	7-21
Marking Rigged Load	7-16	7-21
Equipment Required	7-17	7-21
PART FOUR		
RIGGING A-22 CONTAINER LOADS		
CHAPTER 8		
GENERAL INFORMATION FOR A-22 LOADS		
A-22 Cargo Bag Assembly	8-1	8-1
A-22 Skid Board	8-2	8-1
A-22 Container Limitations	8-3	8-1
Double A-22 Cargo Bag	8-4	8-1
Stretch A-22 Cargo Bag	8-5	8-1
Assembly Line Rigging	8-6	8-1
Inspection of Load	8-7	8-1
Parachutes Used	8-8	8-1
Installation of Parachutes	8-9	8-3

	Paragraph	Page
CHAPTER 9	RIGGING TYPICAL A-22 LOADS	
Section I	RIGGING A-22 LOADS FOR LOW-VELOCITY AIRDROP	
	Description of Load	9-1 9-1
	Preparing Drop Items	9-2 9-1
	Preparing Skid Board	9-3 9-1
	Positioning Honeycomb	9-4 9-3
	Positioning A-22 Cargo Bag Sling, Cover, and Load	9-5 9-4
	Securing A-22 Cargo Bag Cover	9-6 9-5
	Securing A-22 Cargo Bag Sling	9-7 9-6
	Securing Skid Board to A-22 Cargo Bag	9-8 9-7
	Attaching Suspension Webs	9-9 9-8
	Installing Parachute	9-10 9-9
	Marking Rigged Load	9-11 9-9
	Equipment Required	9-12 9-9
Section II	RIGGING A-22 LOADS FOR HIGH-VELOCITY AIRDROP	
	Description of Load	9-13 9-11
	Preparing Items and Skid Board	9-14 9-11
	Positioning Honeycomb	9-15 9-11
	Rigging Container	9-16 9-11
	Installing Parachute	9-17 9-11
	Marking Rigged Load	9-18 9-14
	Equipment Required	9-19 9-14
Section III	RIGGING DOUBLE A-22 CARGO BAG LOADS FOR LOW-VELOCITY AIRDROP	
	Description of Load	9-20 9-16
	Preparing Skid Board	9-21 9-16
	Preparing Skid Board Ties and Positioning Honeycomb	9-22 9-17
	Positioning A-22 Sling Assemblies	9-23 9-18
	Positioning Covers and Honeycomb	9-24 9-20
	Positioning Load and Closing Bag Covers	9-25 9-21
	Securing Tie-Down Straps	9-26 9-22
	Securing Lateral Straps	9-27 9-23
	Securing Skid Board Ties	9-28 9-24
	Installing Suspension Slings	9-29 9-25
	Installing Parachute	9-30 9-26
	Marking Rigged Load	9-31 9-27
	Equipment Required	9-32 9-27

	Paragraph	Page
Section IV	RIGGING STRETCH A-22 CARGO BAG LOADS FOR LOW-VELOCITY AIRDROP	
	Description of Load	9-33 9-29
	Preparing Skid Board	9-34 9-29
	Preparing Skid Board Ties and Positioning Honeycomb	9-35 9-30
	Positioning A-22 Sling Assemblies	9-36 9-31
	Positioning Covers and Honeycomb	9-37 9-33
	Positioning Load and Closing Bag Covers	9-38 9-34
	Securing Tie-Down Straps	9-39 9-35
	Securing Lateral Straps	9-40 9-36
	Securing Skid Board Ties	9-41 9-37
	Installing Suspension Slings	9-42 9-38
	Installing Parachute	9-43 9-39
	Marking Rigged Load	9-44 9-40
	Equipment Required	9-45 9-40
CHAPTER 10	RIGGING SPECIFIC SINGLE A-22 LOADS	
Section I	RIGGING TRAY-PACK RATIONS FOR LOW-VELOCITY AIRDROP	
	Description of Load	10-1 10-1
	Preparing Load	10-2 10-1
	Preparing Skid Board	10-3 10-1
	Positioning Honeycomb	10-4 10-1
	Rigging Load	10-5 10-1
	Installing Parachute	10-6 10-1
	Marking Rigged Load	10-7 10-1
	Equipment Required	10-8 10-3
Section II	RIGGING COMPANY-LEVEL FIELD FEEDING KITCHEN FOR LOW-VELOCITY AIRDROP	
	Description of Load	10-9 10-5
	Preparing Skid Board	10-10 10-6
	Positioning Honeycomb	10-11 10-6
	Positioning Container, Base, and Leg Braces	10-12 10-7
	Preparing Heater Cabinet	10-13 10-8
	Preparing Pot Assembly	10-14 10-12
	Positioning Load	10-15 10-13
	Closing Container	10-16 10-19
	Completing Rigged Load and Installing Parachute	10-17 10-19
	Marking Rigged Load	10-18 10-20
	Equipment Required	10-19 10-20
Section III	RIGGING PETROLEUM PRODUCTS	
	Description of Load	10-20 10-23
	Preparing Skid Board and Positioning Honeycomb	10-21 10-23
	Positioning Container	10-22 10-23
	Positioning Load	10-23 10-23
	Securing Container and Installing Parachute	10-24 10-23
	Equipment Required	10-25 10-23

	Paragraph	Page
CHAPTER 11	RIGGING SPECIFIC DOUBLE A-22 LOADS FOR LOW-VELOCITY AIRDROP	
Section I	RIGGING SNOWMOBILE	
	Description of Load	11-1 11-1
	Preparing Skid Board	11-2 11-1
	Positioning Container	11-3 11-1
	Positioning Honeycomb	11-4 11-1
	Preparing Snowmobile	11-5 11-4
	Positioning Load	11-6 11-6
	Completing Rigged Load	11-7 11-8
	Marking Rigged Load	11-8 11-8
	Equipment Required	11-9 11-8
Section II	RIGGING AHKIO SLEDS	
	Description of Load	11-10 11-11
	Preparing Skid Board and Positioning Honeycomb and Container	11-11 11-11
	Positioning Load	11-12 11-11
	Completing Rigged Load	11-13 11-11
	Marking Rigged Load	11-14 11-13
	Equipment Required	11-15 11-13
PART FIVE	RIGGING SPECIALIZED LOADS AND EQUIPMENT	
CHAPTER 12	RIGGING A-23 CONTAINERS	
	Description of Load	12-1 12-1
	Modifying 68-Inch Pilot Parachute	12-2 12-2
	Rigging Container	12-3 12-4
	Completing Rigged Load	12-4 12-4
	Marking Rigged Load	12-5 12-8
	Equipment Required	12-6 12-8
CHAPTER 13	FABRICATING AIR FORCE AIRDROP EQUIPMENT	
Section I	AIR FORCE UNILATERAL TRAINING	
	Description of SATB	13-1 13-1
	Preparing Sandbag	13-2 13-1
	Fabricating SATB	13-3 13-2
	Attaching Pendulum Line	13-4 13-5
	Packing and Installing Pilot Parachute	13-5 13-7
	Attaching Marker Light	13-6 13-8
	Using Extraction Parachute Deployment Bag	13-7 13-8
	Equipment Required	13-8 13-8
Section II	FABRICATING OF C-130 CDS PULLEY STRAP	
	Description of C-130 CDS Pulley Strap	13-9 13-10
	Preparing C-130 CDS Pulley Strap	13-10 13-10
GLOSSARY		Glossary-1
REFERENCES		References-1

PREFACE

PURPOSE

This manual gives the latest approved doctrine for rigging airdrop containers. It is written for use by a parachute rigger or jumpmaster. It consists of five parts.

- Part One contains general information for containers and aircraft.
- Part Two contains procedures for rigging A-7A container loads.
- Part Three contains procedures for rigging A-21 container loads.
- Part Four contains procedures for rigging A-22 container loads.
- Part Five contains procedures for rigging specialized loads and equipment.

NOTICE OF EXCEPTION

When an item of airdrop equipment is replaced or a rigging procedure is changed, it will be impossible to change all manuals in the field at one time. Therefore, FM 10-500-3/TO 13C7-1-11/FMFM 7-47 will be changed, when necessary, and will take precedence over the procedures in an individual rigging manual. There may be times, however, when the procedures in an individual rigging manual must be followed even though they are different from those in this manual. When this occurs, a notice of exception will be printed at the beginning of each paragraph where the exception is authorized. The notice of exception will look like the following:

NOTICE OF EXCEPTION

The procedures in this paragraph are different from those in FM 10-500-3/TO 13C7-1-11/FMFM 7-47. An exception to FM 10-500-3/TO 13C7-1-11/FMFM 7-47 is granted. The procedures in this paragraph must be followed.

Manuals which have currently been granted exceptions are FM 10-550/TO 13C7-22-71 and FM 10-500-53/TO 13C7-18-41/MCRP 4-3.8.

REFERENCE INFORMATION

To avoid repeating certain information and procedures, it is often necessary to reference other FMs and TMs. For example, this manual often references FM 10-500-2/TO 13C7-1-5. This may seem to be contradictory in that this manual, FM 10-500-3/TO 13C7-1-11/FMFM 7-47, deals with rigging container loads and FM 10-500-2/TO 13C7-1-5 deals with rigging platform loads. However, FM 10-500-2/TO 13C7-1-5 also provides general information and general procedures. Where information is the same or only minor differences exist, it is permissible to state that the information is provided in FM 10-500-2/TO 13C7-1-5. Where procedures are the same or only minor differences exist, it is permissible to state that the procedure is done according to or by adapting the procedures in FM 10-500-2/TO 13C7-1-5.

USER INFORMATION

The proponent of this publication is HQ TRADOC. You are encouraged to report any errors or omissions and suggest ways for making this a better manual. Army personnel, send your comments on DA Form 2028 directly to:

Airborne and Field Services Department
USA Quartermaster Center and School
1010 Shop Road
Fort Lee, VA 23801-1502

Air Force personnel, send your reports on AFTO Form 22 through:

Headquarters
Air Mobility Command (AMC/DOTX)
402 Scott Drive Unit 3A1
Scott AFB, IL 62225-5302

Air Force personnel in Air Combat Command, send your reports on AFTO Form 22 through:

HQ ACC/DOTW
205 Dodd Boulevard, Suite 101
Langley AFB, VA 23665-2789

Air Force personnel in Special Operations Command, send your reports on AFTO Form 22 through:

HQ AFSOC/DOXT
100 Bartley Street, Suite 260
Hurlburt Field, FL 32544-5273

to:

Airborne and Field Services Department
USA Quartermaster Center and School
1010 Shop Road
Fort Lee, VA 23801-1502

Also send information copy of AFTO Form 22 to:

SA-ALC/TILD
485 Quentin Roosevelt Road
Kelly AFB, TX 78241-6421

Marine Corps personnel, send your comments to:

Commanding General
Doctrine Division (C42)
3300 Russell Road, Suite 318A
Quantico, VA 22134-5021

PART ONE GENERAL INFORMATION

CHAPTER 1 GENERAL RIGGING INFORMATION FOR CONTAINER LOADS

Section I RIGGING INFORMATION

1-1. Description of Container Loads

Container loads are loads that are rigged for airdrop in airdrop containers such as the A-7A airdrop cargo sling assembly, the A-21 cargo bag assembly, the A-22 cargo bag assembly, and the A-23 cargo bag assembly. These containers are packed with supplies, disassembled equipment, or small items of ready-to-use equipment prepared for airdrop. Loads may be required to be cushioned with honeycomb, felt, or cellulose wadding depending on the load requirements and the method of airdrop. The number and types of parachutes required to stabilize the load and slow its descent depend on the type of container used, the weight of the load, and the type of airdrop.

a. A-7A Airdrop Cargo Sling Assembly. The A-7A airdrop cargo sling assembly consists of four identical sling straps. The length of each strap is 188 inches. Each sling strap is fitted with a parachute harness adapter (commonly called a friction adapter) and a floating D-ring. Loads weighing up to 500 pounds may be airdropped with an A-7A airdrop cargo sling assembly. Each A-7A cargo sling strap weighs 1 1/2 pounds. Part Two of this manual covers rigging the A-7A container for airdrop.

b. A-21 Cargo Bag Assembly. The A-21 cargo bag assembly is an adjustable container. It consists of a sling assembly with scuff pad, fixed quick-release strap and assembly, two O-ring straps, three quick-release straps, and a 97- by 115-inch canvas cover. The A-21 cargo bag assembly has a 500-pound load capacity. Part Three of this manual covers rigging an A-21 container for airdrop.

c. A-22 Cargo Bag Assembly. The A-22 cargo bag

assembly is an adjustable cotton duck cloth/nylon and nylon webbing container. It consists of a sling assembly, a cover, and four suspension webs. The container weight is about 41 pounds. The load may be rigged with or without a cover. The weight capacity for the container is 501 to 2,200 pounds without the weight of the parachute. The height will vary, but will not exceed 83 inches with parachute unless specific rigging procedure authorizes it. Part Four of this manual covers rigging the A-22 container.

d. Stretch A-22 Cargo Bag. The stretch A-22 cargo bag consists of two A-22 cargo bag assemblies. The covers may or may not be used. Only six of the suspension webs are used. Nylon and cotton sling assemblies must not be mixed. The weight capacity of the load is 900 to 2,200 pounds without the weight of the parachute. Part Four of this manual covers rigging the stretch A-22 container.

e. Double A-22 Cargo Bag. The double A-22 cargo bag consists of two A-22 cargo bag assemblies. The covers may or may not be used. Only six of the suspension webs are used. Nylon and cotton sling assemblies must not be mixed. The weight capacity of the load is 900 to 2,200 pounds without the weight of the parachute. Part Four of this manual covers rigging the double A-22 container.

f. A-23 Cargo Bag. The A-23 sling assembly is similar to the A-22 sling assembly, but it has additional support webs on all four sides with an additional D-ring on each side. The weight capacity of the load is 501 to 2,200 pounds without the weight of the parachute. The A-23 container assembly is used for HAARS drops, but may be used for A-22 drops. Part Five of this manual covers rigging the A-23 container.

1-2. Types of Airdrop

The three types of airdrop by which container loads can be delivered are low-velocity airdrop, high-velocity airdrop, and free drop. These are described below.

a. Low-Velocity Airdrop. Low-velocity airdrop is the delivery of supplies and equipment from an aircraft in flight using cargo parachutes. The items are usually rigged with honeycomb under them. The cargo parachutes are attached to the top of the load. The parachutes slow the descent of the load and ensure minimum shock when the load hits the ground.

b. High-Velocity Airdrop. High-velocity airdrop is the delivery of supplies and equipment from an aircraft in flight using a stabilizing parachute. The items are rigged with honeycomb under them. The stabilizing parachute is attached to the top of the load to maintain it in an upright position.

c. Free Drop. Free drop is the delivery of certain nonfragile items of supply from an aircraft in flight without the use of the parachutes or other retarding devices. No specific instructions are given in this manual for this type of airdrop.

1-3. Commonly Used Items

Items commonly used for rigging container loads are described below. An equipment required table is included for each load in this manual as a part of the section describing that load. This table lists the items and quantity of each item needed to prepare and rig the load covered in that section. Standard airdrop hardware, straps, and canvas items are described in FM 10-500-2/TO 13C7-1-5. Canvas, metal, webbing, and wood items are inspected according to TM 10-1670-298-20&P. Strength ratings for the items in this section and for other airdrop items are listed in FM 10-516/TO 13C7-1-13. Some textile, wood, and miscellaneous items are described below. The proper use of these items will be covered in this manual or in other manuals of the FM 10-500/TO 13C7 series.

a. Textile Items. Textile items which may be used when a container load is being rigged are described below.

NOTE: Lengths will vary. Lengths specified are only typical and may be changed.

(1) Type III nylon cord is used to make safety ties and to hold items in place. It has a tensile strength of 550 pounds.

(2) One-half-inch (or 5/8-inch) tubular nylon webbing is used as a primary skid board tie. It is also used to secure items during a drop. It has a tensile strength of 1,000 pounds.

NOTE: When the 1/2-inch (or 5/8-inch) tubular nylon webbing is not available for the skid board tie, type IV (coreless) braided nylon cord can be used. When the type IV (coreless) braided nylon cord is not available, double length of type III nylon cord can be used.

(3) Type I, 1/4-inch cotton webbing is used to make many of the needed safety ties. It has a tensile strength of 80 pounds.

(4) Ticket number 8/4 and 8/7 cotton thread are used to make various ties.

b. Wood Items. Wood items used on container loads, with the exception of the A-22 skid, are made locally using details found in the rigging manual for the particular load. The 48- by 48-inch skid for the A-22 cargo bag may be ordered pre-cut or prepared locally. When the skid is prepared locally, AC grade plywood must be used.

c. Miscellaneous Items. Miscellaneous items which may be used when a container load is being rigged are described below.

(1) Two-inch masking tape is used to secure the folds of excess webbing, to prevent honeycomb from being cut by type III nylon cord, and to hold padding in place.

(2) Cellulose wadding and felt sheets may be used to pad fragile items, to prevent sharp edges from cutting, and to protect slings during deployment.

(3) Honeycomb is used to spread the landing shock. Honeycomb is also used to fill empty spaces and to level and pad the load. The number of layers used depends on the item being airdropped and the method of airdrop. Honeycomb is issued in 3- by 36- by 96-inch sheets.

(4) Steel strapping may be used for rigging airdrop items. The standard strapping used is 1/50 inch thick and 5/8 inch wide with a breaking strength of 1,000 pounds. It can be used to bind items together or form containers on A-7A and A-21 loads. When strapping is used to form containers, it will be doubled and the maximum weight of the load will not exceed 250 pounds without parachute weight. When strapping is used on A-22 or A-23 loads, it will not be bound around the skid board unless specific rigging procedures authorize it.

1-4. Parachute Requirements

The parachute requirements for low-velocity and high-velocity airdrop are as described below.

a. Low-Velocity Airdrop. The 68-inch pilot, T-10 modified cargo, and G-14 cargo parachutes are used singularly with A-7A cargo sling loads and A-21 cargo bag loads being rigged for low-velocity airdrop. Three 68-inch pilot parachutes may also be used only on A-7A cargo sling loads. The G-14 in cluster of two or three parachutes or a G-12 cargo parachute is used with A-22 cargo bag loads. The minimum required weight and the maximum allowable weight for cargo parachutes used on loads rigged for low-velocity airdrop are listed in Table 1-1.

b. High-Velocity Airdrop. A 68-inch pilot parachute is the primary parachute used for a 75- to 150-pound load without parachute weight being prepared for high-velocity airdrop. For loads over 150 pounds, the 12- or 26-foot, high-velocity cargo parachute is the primary parachute and should be used whenever possible. See Table 1-1 for weight ranges. If a 12-foot, high-velocity cargo parachute is not available, a 15-foot cargo extraction parachute packed specifically for use as a high-velocity parachute may be used. If a 26-foot, high-

velocity cargo parachute is not available, a 22-foot cargo extraction parachute packed specifically for use as a high-velocity parachute may be used. Special packing procedures for the 15- and 22-foot cargo extraction parachutes consist of attaching the static lines and replacing the extraction line with a 20-foot cargo sling (see TM 10-1670-278-23&P/TO 13C5-26-2 for 15-foot and TM 10-1670-279-23&P/TO 13C5-27-2 for 22-foot cargo extraction parachute).

1-5. Data Tag for Rigged Loads

A data tag is prepared and secured to each container load so that it can be easily seen. Entries on the tag are used by the Army and Air Force in making inspections and in finding causes for malfunctions. The entries are also used to help the loadmaster determine where to place the loads in the aircraft. Use a ballpoint pen or other waterproof marker to record the following information on the tag:

- Total rigged weight.
- Height, including parachutes.
- Width.
- Overall length.
- Type of parachute/breakaway or nonbreakaway.

Table 1-1. Parachute requirements

Parachutes	Suspended Weight (Pounds)	
	Minimum	Maximum
Low-velocity		
One 68-inch pilot	30	50
Three 68-inch pilot	51	200
One T-10 modified cargo	90	500
One G-14 cargo	200	500
* Two G-14 cargo	501	1,000
* Three G-14 cargo	1,001	1,500
* One G-12E	501	2,200
High-velocity		
** One 68-inch pilot	75	150
Three 68-inch pilot	151	500
** One 12-foot, high-velocity cargo	151	500
One 15-foot cargo extraction	151	500
** One 26-foot, high-velocity cargo	501	2,200
One 22-foot cargo extraction	501	2,200
* On an A-22 load, a G-14 cargo parachute should be used ONLY when a G-12 cargo parachute is not available.		
** Primary parachute.		
<i>Note: Loads with three G-14 cargo parachutes must be dropped one at a time.</i>		

1-6. Computation of Minimum Weight for Container Loads

a. Container loads may be dropped from the paratroop doors or the ramp. The following minimum weight requirements apply.

(1) **Paratroop Door Loads.** Containers dropped from the paratroop doors require a minimum weight of 11 pounds per square foot.

(2) **Ramp loads.** Containers dropped from the ramp require a minimum weight of 28 pounds per square foot.

b. The following information can be used to determine the minimum weight required for a container load. Measure the length, width, and height (without parachute) of each container. Multiply the two largest dimensions (in inches). Divide the answer by 144. Multiply that answer by 28 (or 11 for paratroop door loads). The answer is the minimum allowable weight. See the example in Table 1-2.

Table 1-2. Example of determining minimum allowable weight for ramp container loads

Example	
Height (without parachute)	27 inches
Length	44 inches
Width	21 inches
44 inches x 27 inches = 1,188 square inches	
1,188 ÷ 144 = 8.25 square feet	
8.25 x 28 = 231 pounds	
<i>The minimum allowable weight for this container is 231 pounds, without parachute.</i>	

1-7. Special Considerations

Special considerations for this manual are described below.

CAUTION: Only ammunition listed in FM 10-500-53/TO 13C7-18-41/MCRP 4-3.8 may be airdropped.

a. The loads covered in this manual may include hazardous materials as defined in AFJMAN 24-204/TM 38-250. If included, the hazardous material must be packaged, marked, and labeled as required by AFJMAN 24-204/TM 38-250.

b. A copy of FM 10-500-3/TO 13C7-1-11 must be available to the joint airdrop inspectors during the before- and after-loading inspections.

1-8. Safety Precautions

CAUTION: Package, mark, and label hazardous materials according to AFJMAN 24-204/TM 38-250.

Safety precautions must be closely followed when airdrop container loads are rigged. Failure to follow the precautions could result in serious injury to the rigger or damage to the drop item or aircraft. Take the following safety precautions when rigging an item.

a. Make sure that a lifting device has a rated lifting capacity that exceeds the weight of the item to be lifted.

b. Be sure that items being lifted are secured to the lifting device.

c. Do not work under equipment that is suspended above an airdrop container unless absolutely necessary.

d. Cover all wet cell batteries in service with plastic or nonflammable material.

e. Check the fuel tanks of engines to ensure that they are drained. Check fuel cans to make sure they are POP approved. When stowing fuel containers, use cellulose wadding or other suitable material to prevent metal-to-metal contact.

1-9. Rigging Precautions

The following precautions must be taken when a container load is being rigged.

a. **Assemblies.** When components of assemblies are being rigged, make sure that all items needed to operate the assembly are packed in the same airdrop container whenever possible. For example, a radio and its battery should be packed in the same container.

b. **Items.** When items such as radio equipment are rigged, they should be individually wrapped. Padding or honeycomb should be placed under each item being prepared and inserted between items of the load to prevent contact. Cellulose wadding, felt, or other suitable material must be used to avoid metal-to-metal or metal-to-wood contact.

c. **Webbing.** All excess lengths of webbing must be folded and taped or tied with type I, 1/4-inch cotton webbing. This reduces the danger of containers becoming snagged as they are ejected or released from the aircraft.

d. **Hazardous Materials.** Hazardous materials must be packed and the rigged load labeled or marked according to AFJMAN 24-204/TM 38-250. Gasoline cans and drums must be padded and rigged to prevent metal-to-metal contact.

1-10. Loads Dropped in Frigid Climates

When loads are dropped in frigid climates, special procedures or precautions may need to be followed.

a. Modification to Drop Items. Some drop items may have been modified for use in frigid climates by the installation of extra equipment such as heaters. Special rigging procedures may be needed when a drop item has been modified.

b. Special Rigging Requirements. When loads are to be dropped in frigid climates, all excess webbing of suspension slings and tie-down straps must be folded and tied with type I, 1/4-inch cotton webbing.

CAUTION: Masking tape **MUST** not be used in frigid climates to secure folds or excess webbing.

1-11. Final Inspection

After the data tag has been attached, the rigged load must be given a complete and final inspection by a qualified person. A-7A and A-21 loads may be inspected by either the jumpmaster or parachute rigger. If the load is rigged for HAARS, it must be inspected by a parachute rigger. All A-22 and A-23 loads will be

inspected by a parachute rigger. The inspection must include the following:

- Check for serviceability of webbing, straps, and covers.
- Make sure the load is rigged according to procedures.
- Make sure the loads containing hazardous materials comply with AFJMAN 24-204/TM 38-250 and are labeled accordingly.
- Make sure the proper size parachute has been used, and check its condition.
- Inspect the log record book.
- Make sure that the parachute is correctly connected to the load.

1-12. Release Gate

A release gate is installed in the aircraft to restrain the load during flight. It is also used to prevent premature exit of container loads from the aircraft. The gate is installed according to procedures in the technical order for the particular aircraft used. The components of the type XXVI nylon webbing release gate, with the exception of the webbing to be severed, are furnished by the US Air Force. The type XXVI nylon webbing is furnished by the user.

See Table 1-3 for release gate requirements.

Table 1-3. Release gate requirements

		Rigged Weight (Pounds)	Lengths of Type XXVI Nylon Webbing Required
C-130 and C-141 aircraft	Non-CVRS	501 - 13,000	One 20-foot
		13,001 - 25,000	Two 20-foot
		25,001 - 40,000	Three 20-foot
C-130 and C-141 aircraft	CVRS	501 - 13,000	One 15-foot per stick
		13,001 - 25,000	Two 15-foot per stick
C-17 aircraft	Inboard Logistics Rail	501 - 18,800	20-foot single stick
		18,801 - 37,600	40-foot double stick

Note: For multiple deliveries, provide a release gate based on the weight of each group of containers to be airdropped at one time.

1-13. Knots Used

Some of the knots used for rigging container loads are shown in Figure 1-1.

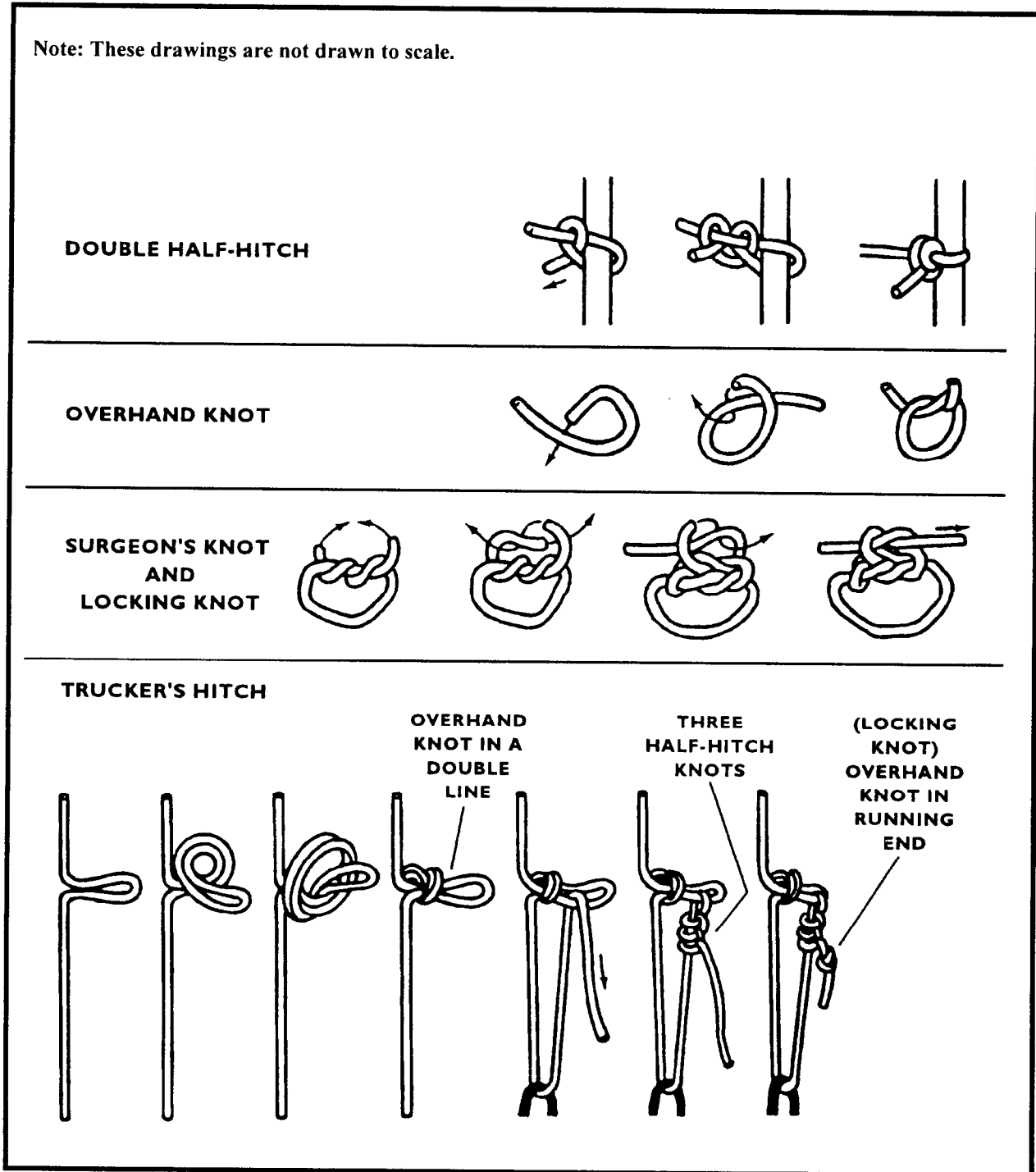

Figure 1-1. Knots used

1-14. Securing of Straps and Webbing

CAUTION: Instructions given in this paragraph must be followed exactly to ensure a malfunction-free drop.

The straps and webbing used to rig loads must be properly fastened and secured.

a. Fastening Straps With Friction Adapters. All the containers in this manual have friction adapters attached somewhere on the container. It is critical

that the running ends of straps are routed properly. Figure 1-2 identifies the parts of the friction adapter. Figure 1-3 shows how to route the running end of a strap through the friction adapter.

b. Securing Excess Strap. Excess strap is folded and tied with type I, 1/4-inch cotton webbing or 2-inch masking tape. Masking tape cannot be used for drops in frigid climates. Figure 1-3 shows how to secure excess straps.

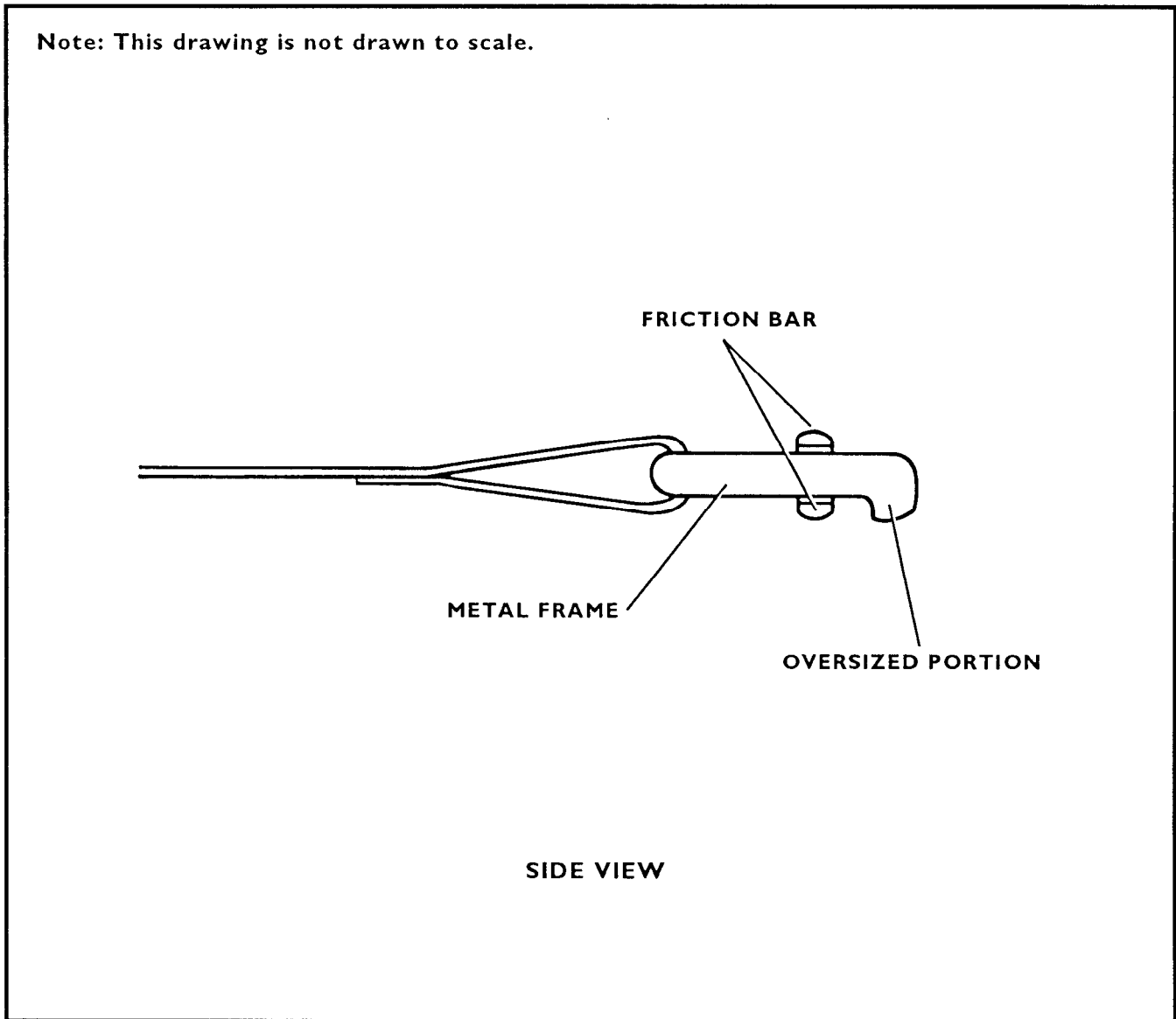
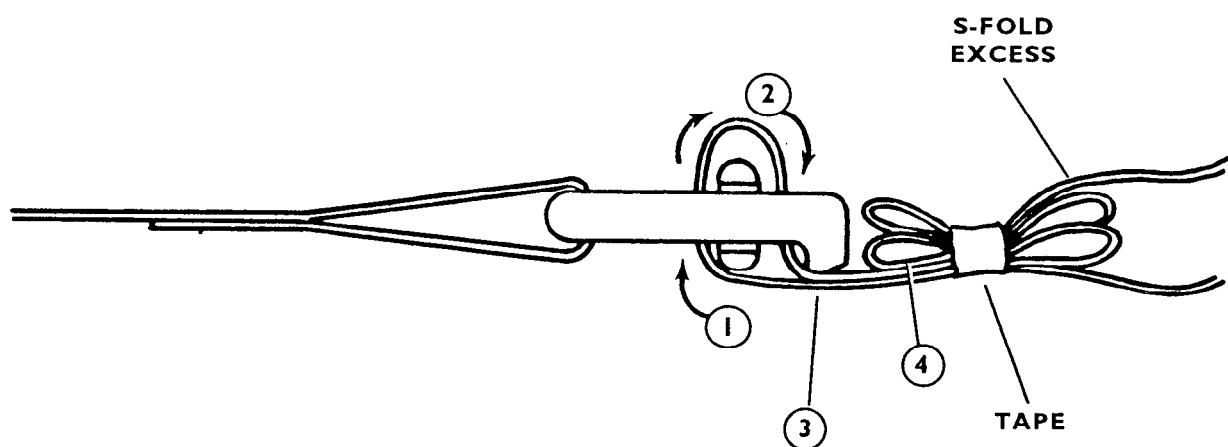

Figure 1-2. Friction adapter

Note: This drawing is not drawn to scale.



- ① Using the running end of the strap, route it up from the bottom between the friction bar and the stitch formation side of the metal frame.
- ② Bring the running end down between the friction bar and the oversized portion of the metal frame.
- ③ Pull tension. The oversized portion of the metal frame should be pressing against the two layers of strap.
- ④ Fold the excess. Secure it with either one turn single of type I, 1/4-inch cotton webbing using a surgeon's knot and locking knot or two turns of 2-inch masking tape.

Figure 1-3. Strap routed and excess secured

Section II

HIGH-ALTITUDE AIRDROP RESUPPLY SYSTEM

1-15. Description of HAARS

The HAARS is designed to resupply from aircraft flying up to 25,000 feet. It uses both high-velocity and low-velocity airdrop. At release from aircraft, the load accelerates to terminal velocity--250 feet per second. HAARS uses a 30-inch or a modified 68-inch pilot parachute to remain upright until the right altitude is reached and the altitude sensor parachute staging unit activates, which begins cargo parachute deployment. The load lands at a rate under or up to 28 feet per second. There are two rigged weight ranges.

a. The 500-pound system uses either A-7A or A-21 containers. It can weigh 200 to 500 pounds without parachutes. This load can exit the aircraft either from the paratroop door or ramp. TM 10-1670-267-12&P/TO 13C7-1-101 covers the maintenance of this system.

b. The 2,200-pound system uses an A-23 container. It can weigh 501 to 2,200 pounds without parachute. This load is CVRS compatible. TM 10-1670-265-12&P/TO 13C7-1-21 covers the maintenance of this system.

1-16. Altitude Sensor Parachute Staging Unit

The unit is covered by TM 10-1670-266-13&P. The maintenance and servicing are conducted before rigging. The sensor is set 1,900 feet above drop zone elevation. The 1,900 feet will allow 800 feet for parachute deployment, 600 feet for sensor location error, and 500 feet as a safety factor. Use TM 10-1670-266-13&P for complete setting instructions.

CHAPTER 2 AIRCRAFT INFORMATION

2-1. Army Aircraft

CAUTION: Container loads that are to be airdropped from helicopter doors and doors of utility aircraft must be rigged with parachutes equipped with breakaway static lines.

The following Army aircraft are used to airdrop loads.

a. UH-1 (Iroquois) Helicopter. The UH-1 helicopter can carry supplies both internally (door loads) and externally (cargo hook loads). The allowable weight of the total cargo load is determined by responsible aviation personnel using weight limitation data provided in TM 55-1520-210-10. The weight and dimensional limits for both the door loads and the cargo hook loads are listed in Table 2-1.

b. UH-60 (Blackhawk) Helicopter. The UH-60 helicopter can carry supplies both internally (door loads) and externally (cargo hook loads). The allowable weight of the total cargo load is determined by responsible aviation personnel using weight limitation data provided in TM 55-1520-237-10. The weight and dimensional limits for both door loads and cargo hook loads are listed in Table 2-1.

c. CH-47 (Chinook) Helicopter. The CH-47 helicopter can deliver supplies as ramp loads and as cargo hook loads. The weight allowance of the total cargo load is determined by responsible aviation personnel using weight limitation data provided in TM 55-1520-240-10. Any standard A-7A cargo sling, A-21 cargo bag, or A-22 cargo bag load may be dropped from the cargo ramp. The maximum size of the load dropped from the external cargo hook is limited only by the maximum dimensions of the container.

Table 2-1. Load limitations for UH-1D and UH-60 helicopters

Door Load Data	UH-1D	UH-60
Weight (without parachutes)		
Maximum for A-7A or A-21	500 lb	500 lb
Minimum for each container	*	*
Dimensions (including parachutes)		
Length	48 in	48 in
Width	30 in	30 in
Height	42 in	42 in
* See Table 1-1 for the minimum weight requirements which are based on type of parachute used.		
Cargo Hook Load Data		
Weight. The maximum weight of the load is limited by the rated weight capability of the container and the maximum weight restrictions on the cargo hook.		
Dimensions. The maximum size of the load is limited only by the dimensions of the container.		

2-2. Air Force Aircraft

The C-130, C-141, and C-17 aircraft can deliver container loads from the paratroop door or from the cargo ramp.

a. Paratroop Door Loads. The maximum weight limit for the paratroop door load is 500 pounds excluding the weight of the parachute. However, if the load weighs more than 350 pounds, three trained designated pushers must assist the jumpmaster in pushing the load from the aircraft. The dimensions including the parachute must not exceed 48 by 30 by 66 inches. Loads are dropped before parachutists. Loads followed immediately by parachutists are rigged with parachutes having breakaway static lines. When the load is dropped from the paratroop door, the largest dimension will be placed in the upright position. The parachute must be placed on top of the load, or toward the inside of the aircraft.

b. Ramp Loads. A-7A and A-21 loads may be dropped off the ramp if a 42-inch skid board is attached. A-22 containers are dropped from the cargo ramp in a single or double stick. The number of containers dropped will vary depending on the type of aircraft and the skid board size (see Table 2-2 or 2-3). The maximum height of a container must not exceed 83 inches; the width of the container must not exceed 48 inches.

NOTE 1: Loads to be followed immediately by parachutists must be rigged, unless specified, with parachutes having breakaway static lines.

NOTE 2: High-velocity CDS must be rigged with breakaway static lines.

2-3. CVRS

The centerline vertical restraint system was designed to restrain container loads vertically in Air Force aircraft.

a. Description. The CVRS is designed to work with the dual rail system in an Air Force aircraft. It adds a rail in the center of the cargo area. The rail runs from the front of the cargo area of the aircraft to the rear and is bolted in place. Aircraft without the CVRS in place may be loaded with containers in a single stick formation in the center of the cargo area of the aircraft. Aircraft equipped with the CVRS in place may be loaded with A-22 containers positioned in a right stick formation, left stick formation, or both. On aircraft with the CVRS in place, when an A-22 container is being positioned in the right stick, the right edge of the skid is positioned in the right rail of the aircraft dual rail system and the left edge of the skid is positioned in the center rail. The left stick is loaded in a similar manner. On aircraft with the CVRS in place, each stick of containers is independent of the other.

NOTE: Any overhang must be placed lengthwise in the aircraft. If the container load has an overhang on three or four sides, the load must be dropped in a centerline configuration (non-CVRS).

b. Capabilities. Air Force aircraft equipped with the CVRS can drop single or double A-22 container loads in a single or double stick formation. Both sticks may be released simultaneously, or each stick can be dropped separately. All containers in a stick may be dropped on the same drop zone, or any combination of containers may be dropped on different drop zones. A separate release gate is required for each container or group of containers in each stick to be dropped on a separate drop zone. See Table 1-3 for release gate requirements.

Table 2-2. C-130 and C-141 aircraft CDS capabilities

Aircraft	Non-CVRS	CVRS
C-130		
48- by 48-inch skid	Only single stick, 1-8 containers.	Single or double stick, 1-16 containers. Must be dropped in even numbers when dropping double stick.
48- by 72-inch stretch container	Only single stick, 1-6 stretch containers.	Single or double stick, 1-12 stretch containers. Must be dropped in even numbers when dropping double stick.
48- by 96-inch double A-22 container	Only single stick, 1-4 double containers.	Single or double stick, 1-8 double containers. Must be dropped in even numbers when dropping double stick.
Number of separate drop zones capable of dropping to	Limited to number of drop zones.	Limited to number of bundles. Must be dropped in even numbers when dropping double stick.
C-141		
48- by 48-inch skid	Only single stick, 1-20 containers.	Single or double stick, 1-40 containers. Must be dropped in even numbers when dropping double stick.
48- by 72-inch stretch A-22 container	Only single stick, 1-15 stretch containers.	Single or double stick, 1-30 stretch containers. Must be dropped in even numbers when dropping double stick.
48- by 96-inch double A-22 container	Only single stick, 1-10 containers.	Single or double stick, 1-20 double containers. Must be dropped in even numbers when dropping double stick.
Number of separate drop zones capable of dropping to	Limited to number of drop zones.	Limited to number of bundles. Must be dropped in even numbers when dropping double stick.
<i>Note: If the loads have a front or rear overhang, the number of container loads will be reduced.</i>		

2-4. Inboard Logistics Rail

The inboard logistics rail was designed to restrain container loads vertically in the C-17 aircraft.

a. Description. The inboard logistics rail is a permanent rail in the center of the C-17 aircraft cargo area. It runs from the front of the cargo area to the rear and folds down when not in use. The aircraft may be loaded with A-22 containers positioned in the right stick formation, left stick formation, or both. When

A-22 containers are being positioned in the right stick, the right edge of the skid is positioned in the right rail of the aircraft air delivery system rail and the left edge of the skid is positioned in the inboard logistics rail. The left stick is loaded in a similar manner. Each stick of containers is independent of the other.

NOTE: The width of the container load **MUST NOT** exceed 48 inches.

b. Capabilities. The C-17 aircraft can drop single or double A-22 cargo bag loads in either a single or double stick configuration, but double sticks must have an even number of containers. Both sticks may be released simultaneously, or each stick can be dropped separately. All containers in a stick may be dropped on

the same drop zone, or any combination of containers may be dropped on different drop zones. A separate release gate is required for each container or group of containers in each stick to be dropped on a separate drop zone. See Table 1-3 for release gate requirements.

Table 2-3. C-17 aircraft CDS capabilities

Aircraft	Inboard Logistics Rail
<p>C-17</p> <p>48- by 48-inch skid</p> <p>48- by 72-inch stretch A-22 container</p> <p>48- by 96-inch double A-22 container</p> <p>Number of separate drop zones capable of dropping to</p> <p><i>Note: If the loads have a front or rear overhang, the number of containers will be reduced.</i></p>	<p>Single or double stick, 1-30 containers. Must be dropped in even numbers when dropping double stick.</p> <p>Single or double stick, 1-20 stretch containers. Must be dropped in even numbers when dropping double stick.</p> <p>Single or double stick, 1-14 double containers. Must be dropped in even numbers when dropping double stick.</p> <p>Six for single stick and up to five for double stick. Must be dropped in even numbers when dropping double stick.</p>

2-5. Release Gate Load Spreader

Anytime a container is rigged for CDS and offered as the aft-most container but cannot firmly support the release gate to prevent excessive load shift, it must have a release gate load spreader. When the total weight of containers being dropped from the C-17 and C-141 exceeds 38,000 pounds, a release gate load spreader is needed for each aft-most container. Construct and secure it as given below.

- a.** Nail two 3/4- by 24- by 48-inch pieces of plywood together using eightpenny nails.
- b.** Drill a 1/2-inch hole 2 inches from each corner.

c. Place the spreader between the sling assembly and cover or load so that the 48-inch side is parallel to the top and bottom of the container. Center the spreader on the release gate.

d. Secure the corners of the spreader to the load with type III nylon cord routed through the 1/2-inch holes.

NOTE 1: The user is responsible for offering a gate load spreader to prevent excessive load shift.

NOTE 2: The number of JAI Forms will be determined by the number of gate release plans.

2-6. Capabilities of Non-CVRS Loads

The CVRS was designed to restrain the load vertically during the aircraft flight. When the load is not restrained to CVRS standards, it must be vertically restrained for flight. These restraints will be removed up to 30 minutes before airdrop. After the restraints are

removed, the aircraft will have reduced maneuverability for threat avoidance. Table 2-4 states the limitations that will occur if non-CVRS loads are used.

NOTE: When using the 48- by 53 1/2-inch skid board, drill sixteen 1/2-inch holes as shown in Figure 9-1. Then secure the skid board to the load as shown in Figure 9-6.

Table 2-4. Capability reduction of non-CVRS loads

Item	Limitations
Steel strapping	When steel strapping is used on the skid board, the load becomes non-CVRS compatible. The CVRS must be removed from the aircraft and vertical restraints must be installed.
53 1/2- by 48-inch skid board (CVRS installed)	When dropped with the CVRS, the 48-inch sides become the front and rear. The load can be dropped in either a double or single stick, but double sticks must have an even number of containers. The aircraft capabilities are C-130--1 to 14 containers; C-141--1 to 36 containers.
53 1/2- by 48-inch skid board (CVRS removed)	When the CVRS is removed, the 53 1/2-inch sides remain the front and rear. The load can be dropped in either a double or single stick, but double sticks must have an even number of containers. The load must be vertically restrained. The aircraft capabilities are C-130--1 to 16 containers; C-141--1 to 40 containers.
53 1/2- by 48-inch skid board (Inboard Logistics Rail)	When dropped with the inboard logistics rail, the 48-inch sides become the front and rear. The load can be dropped in either a double or single stick, but double sticks must have an even number of containers. The aircraft capability is C-17--1 to 26 containers.
53 1/2- by 96-inch skid board	This container is not CVRS-compatible. The system must be removed. Vertical restraints must be installed. The 53 1/2 -inch sides are the front and rear.

Note: If the loads have a front or rear overhang, the number of containers will be reduced.

PART TWO RIGGING A-7A CONTAINER LOADS

CHAPTER 3 GENERAL INFORMATION AND PROCEDURES

3-1. A-7A Airdrop Cargo Sling Assembly

The A-7A airdrop cargo sling assembly consists of four D-rings and four identical sling straps. Each strap is 188 inches long and has a parachute harness

adapter (friction adapter) attached at one end. If needed, more than four straps may be used to secure loads. Figure 3-1 shows an A-7A airdrop cargo sling assembly.

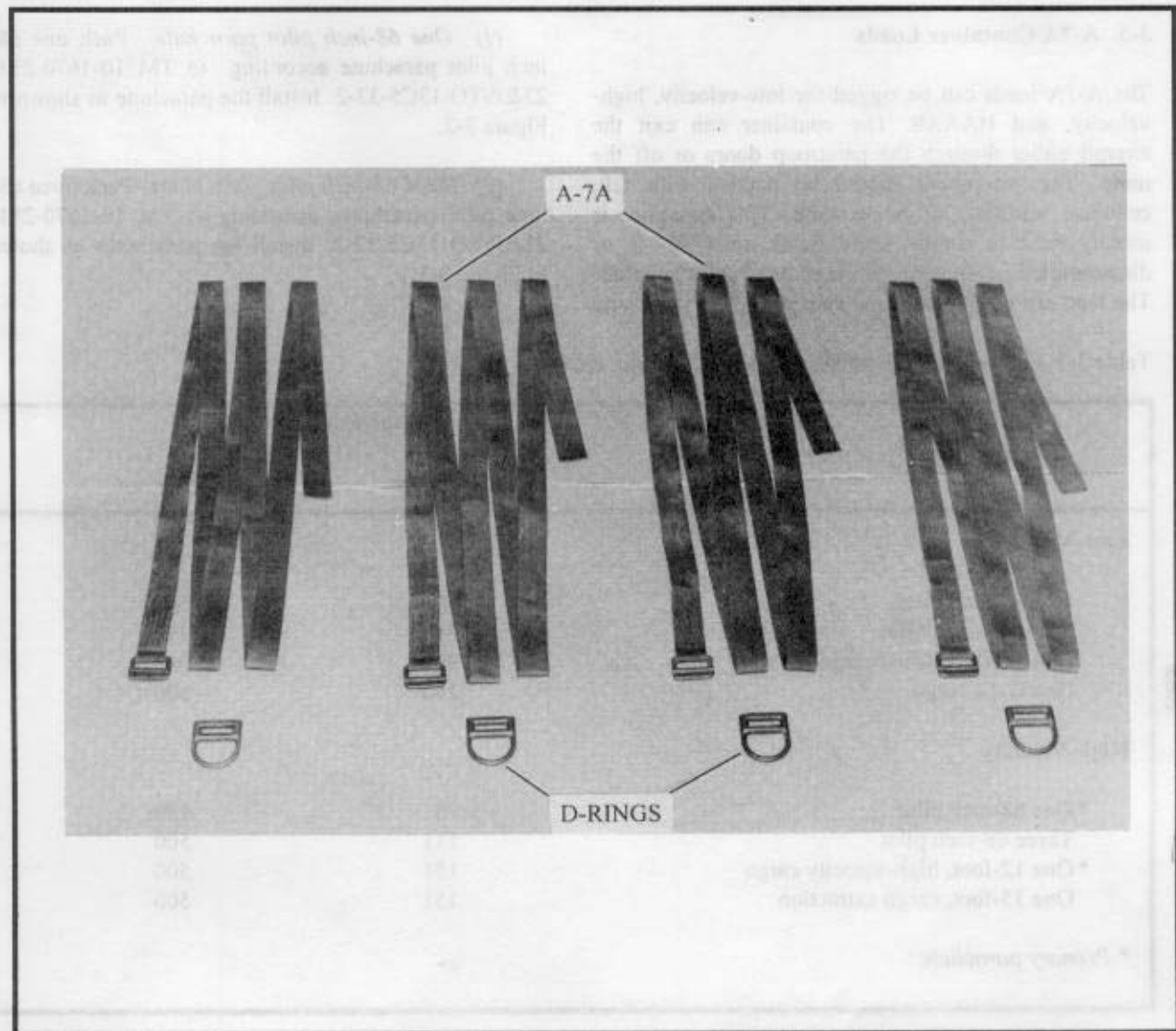

Figure 3-1. A-7A airdrop cargo sling assembly

3-2. Weight Limits

The maximum weight of this container will vary according to the number of straps, but must not exceed 500 pounds. When two straps are used, 300 pounds is the maximum weight. With three straps, 400 pounds is the maximum weight. When four or more straps are used, the maximum weight must not exceed 500 pounds. The minimum weight will vary according to the parachute used. When dropped from the paratroop doors, the load must weigh a minimum of 11 pounds per square foot. When dropped from the ramp, the load must weigh a minimum of 28 pounds per square foot. Table 3-1 lists parachutes used with this container and the weight restriction.

3-3. A-7A Container Loads

The A-7A loads can be rigged for low-velocity, high-velocity, and HAARS. The container can exit the aircraft either through the paratroop doors or off the ramp. The equipment should be padded with felt, cellulose wadding, or honeycomb. This container is usually used to supply small items, ready-to-use or disassembled equipment, or other nonfragile supplies. The load can be rigged by the using unit. The parachute

must be packed by a parachute rigger. It is only required to be inspected by a jumpmaster or parachute rigger. The HAARS must be rigged and inspected by a parachute rigger.

3-4. Parachutes for A-7A Loads

To select a parachute for an A-7A load, consider the type of airdrop (low-velocity or high-velocity) and the weight of the rigged container (Table 3-1). Pack and install the parachute as described below.

a. Low-Velocity Loads. The parachutes that can be used to rig an A-7A load for low-velocity airdrop are given below.

(1) *One 68-inch pilot parachute.* Pack one 68-inch pilot parachute according to TM 10-1670-281-23&P/TO 13C5-32-2. Install the parachute as shown in Figure 3-2.

(2) *Three 68-inch pilot parachutes.* Pack three 68-inch pilot parachutes according to TM 10-1670-281-23&P/TO 13C5-32-2. Install the parachutes as shown in Figure 3-3.

Table 3-1. Parachute requirements for A-7A container loads

Parachutes	Suspended Weight (Pounds)	
	Minimum	Maximum
Low-Velocity		
One 68-inch pilot	30	50
Three 68-inch pilot	51	200
One T-10 modified cargo	90	500
One G-14 cargo	200	500
High-Velocity		
* One 68-inch pilot	75	150
Three 68-inch pilot	151	500
* One 12-foot, high-velocity cargo	151	500
One 15-foot, cargo extraction	151	500
* <i>Primary parachute</i>		

Note: Use masking tape only.

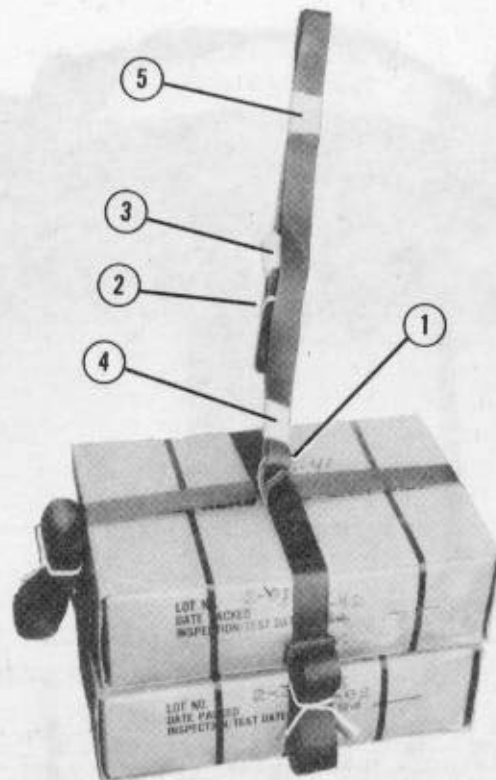

- ① Pass the free end of an A-7A strap through the D-ring on top of the load. Pass the free end of the strap through the friction adapter. Tighten the strap until a 24-inch loop is formed.

Note: Route the strap so that the oversized portion of the metal frame is down. Make sure the friction adapter is about halfway down the strap.

- ② Fold the excess strap. Secure the excess straps according to Chapter 1.
- ③ Tape the friction adapter.
- ④ Tape the strap together 2 inches above the D-ring.
- ⑤ Tape the other end of the strap together so that a 3-inch loop is formed.

Figure 3-2. One 68-inch pilot parachute installed

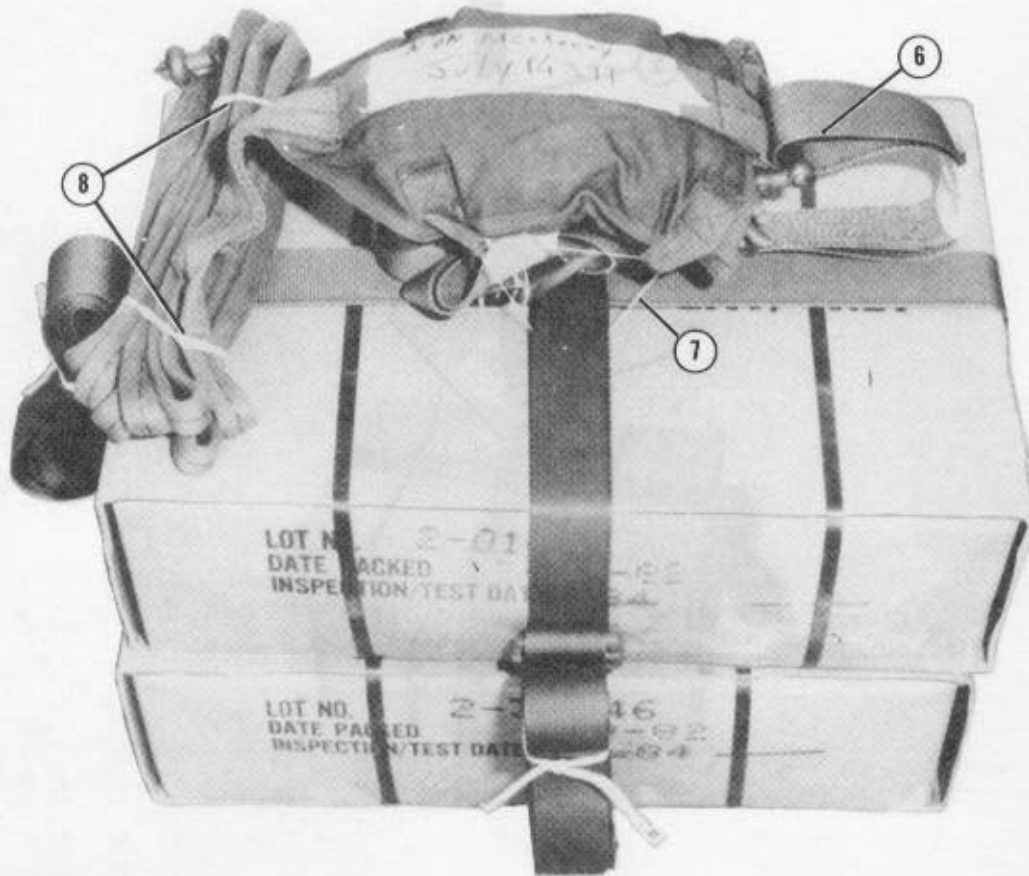

- ⑥ Place the 3-inch loop on the parachute L-bar connector link. Fasten the L-bar connector link.
- ⑦ Place the 68-inch pilot parachute on top of the load. Tie each side of the parachute to one A-7A strap with a length of ticket number 8/7 cotton thread.
- ⑧ Fold the static line, and secure it on top of the load with retainer bands.

Figure 3-2. One 68-inch pilot parachute installed (continued)

Note: Use masking tape only.

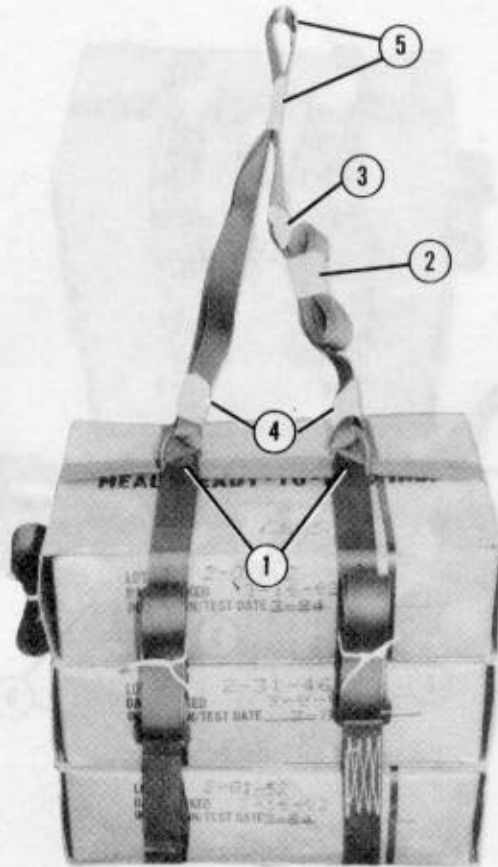

- ① Pass the free end of an A-7A strap through the D-rings on top of the load. Pass the free end of the strap through the friction adapter. Pull both plies of the strap upward between the D-rings. Tighten the strap until the two plies of the strap are 24 inches above the load.
- ② Fold the excess strap. Secure the excess strap according to Chapter 1.
- ③ Tape the friction adapter.
- ④ Tape the A-7A strap together 2 inches above each D-ring.
- ⑤ Form a 3-inch loop in the center of the A-7A strap. Tape the plies of the strap together below the loop.

Figure 3-3. Three 68-inch pilot parachutes installed

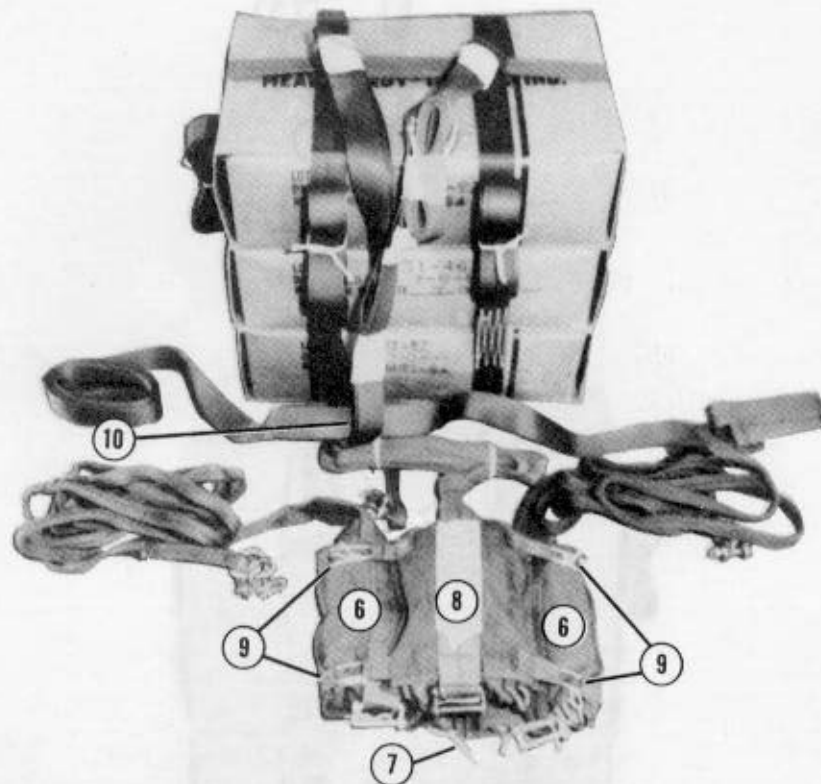

- ⑥ Place two 68-inch parachutes on a flat, dry surface.
- ⑦ Tie the parachutes together using the closer bag attaching loops with one length of ticket number 8/7 cotton thread at the top of the bag and one length at the bottom of the bag.
- ⑧ Place a third parachute on top of the two parachutes placed in step 6.
- ⑨ Tie the top (third) parachute bag attaching loops to the outside bag attaching loops on the bottom parachutes with four lengths of ticket number 8/7 cotton thread.
- ⑩ Pass the free end of another A-7A strap through the 3-inch loop (step 5) in the other A-7A strap.

Figure 3-3. Three 68-inch pilot parachutes installed (continued)

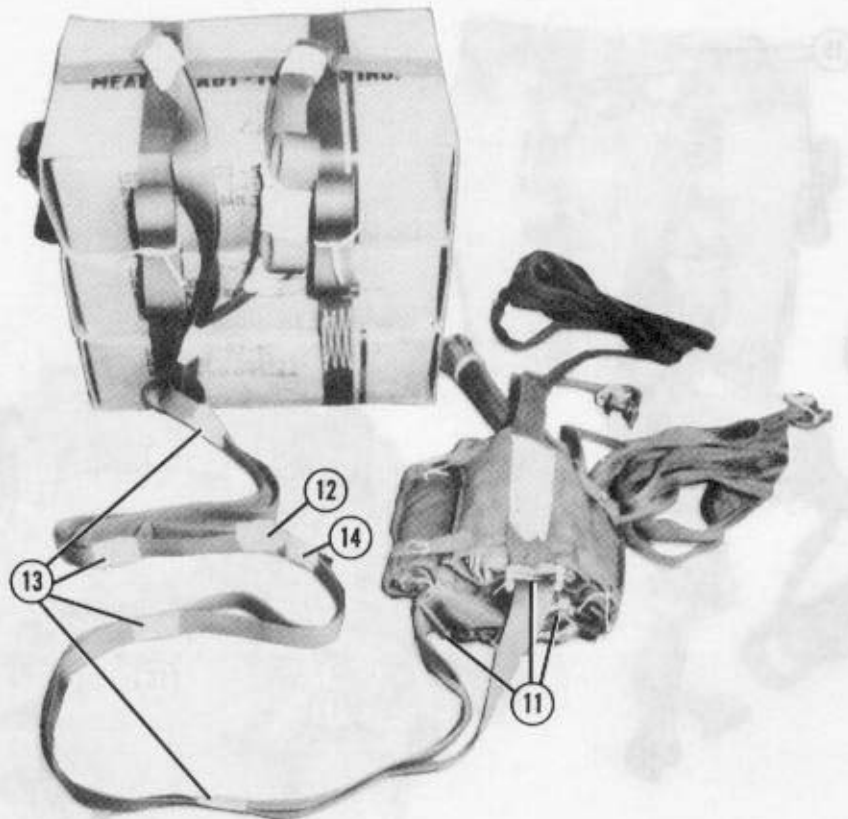

- ⑪ Pass the free end of the A-7A strap (step 10) through the L-bar connector links of the three 68-inch parachutes.
- ⑫ Pass the free end of the A-7A strap through the friction adapter, and tighten it to a length of 7 feet. Tape the friction adapter.
- ⑬ Tape the plies of the A-7A strap together.
- ⑭ Fold and tape the excess strap.

Figure 3-3. Three 68-inch pilot parachutes installed (continued)

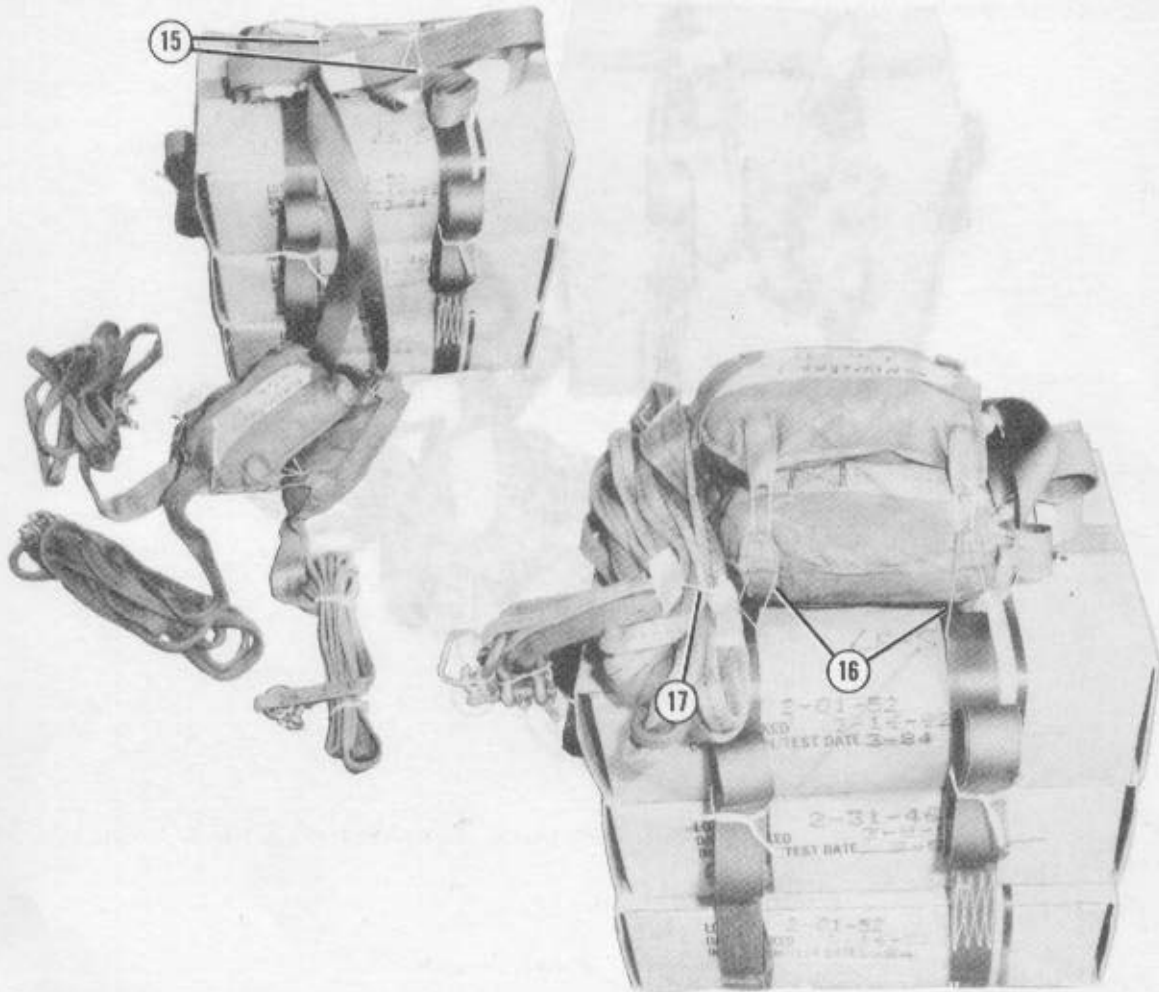

- ⑮ Fold the A-7A straps, and lay them on top of the load. Tie the folds to the top of the load with two lengths of ticket number 8/7 cotton thread.
- ⑯ Place the parachutes on top of the load. Tie the parachute bag attaching loops to the A-7A straps with four lengths of ticket number 8/7 cotton thread.
- ⑰ Tape the parachute static lines together. Tie the static lines to the top of the load with ticket number 8/7 cotton thread.

Figure 3-3. Three 68-inch pilot parachutes installed (continued)

(3) *One T-10 modified cargo parachute.*
 Modify one T-10 parachute according to Paragraph 3-5 and as shown in Figure 3-8. Pack the parachute according to TM 10-1670-293-23&P/TO 14D1-2-467-2. Steps similar to the G-14 cargo parachute installation are used when installing the T-10 modified cargo parachute.

(4) *One G-14 cargo parachute.* Pack one G-14 cargo parachute according to TM 10-1670-282-23&P/TO 13C5-30-2. Install the parachute as shown in Figure 3-4.

Note: This drawing is not drawn to scale.

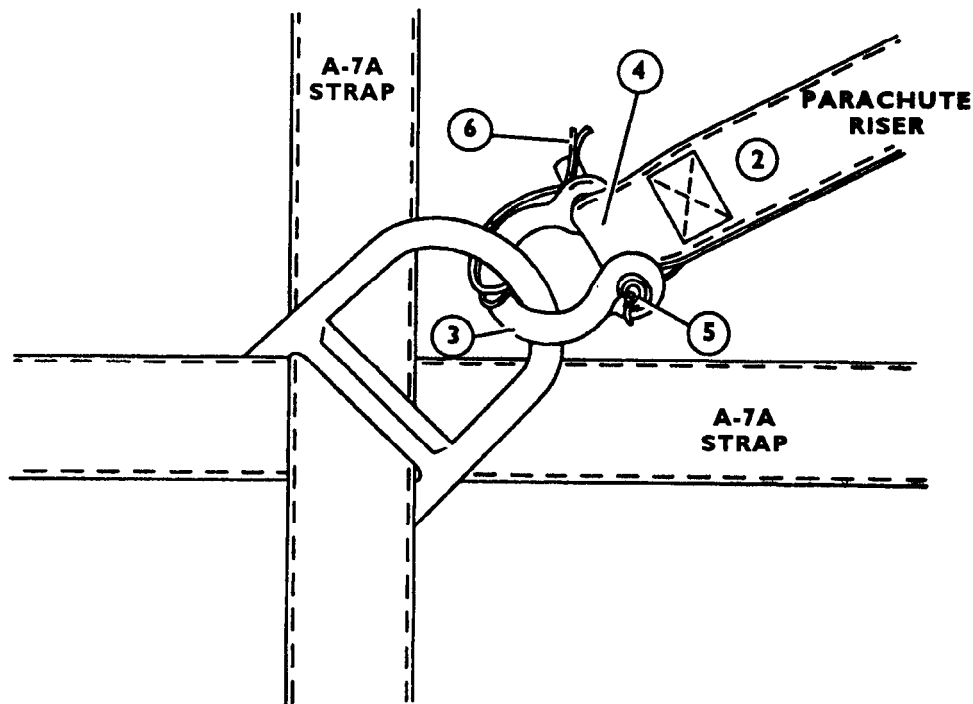

- 1 Place the parachute (not shown) on top of the load between the D-rings.
- 2 Pull each riser to the closest D-ring.
- 3 Place the bell portion of the clevis on one D-ring.
- 4 Place the loop on the end of the riser between the clevis arms.
- 5 Insert the clevis pin through the hole in the clevis arm, through the loop on the riser, and through the hole in the other clevis arm.
- 6 Insert the cotter pin in the hole of the clevis pin. Spread the ends of the cotter pin enough to prevent the cotter pin from sliding out of the clevis pin.
- 7 Attach the other riser to the other D-ring as described in steps 3 through 6.

Figure 3-4. G-14 cargo parachute installed

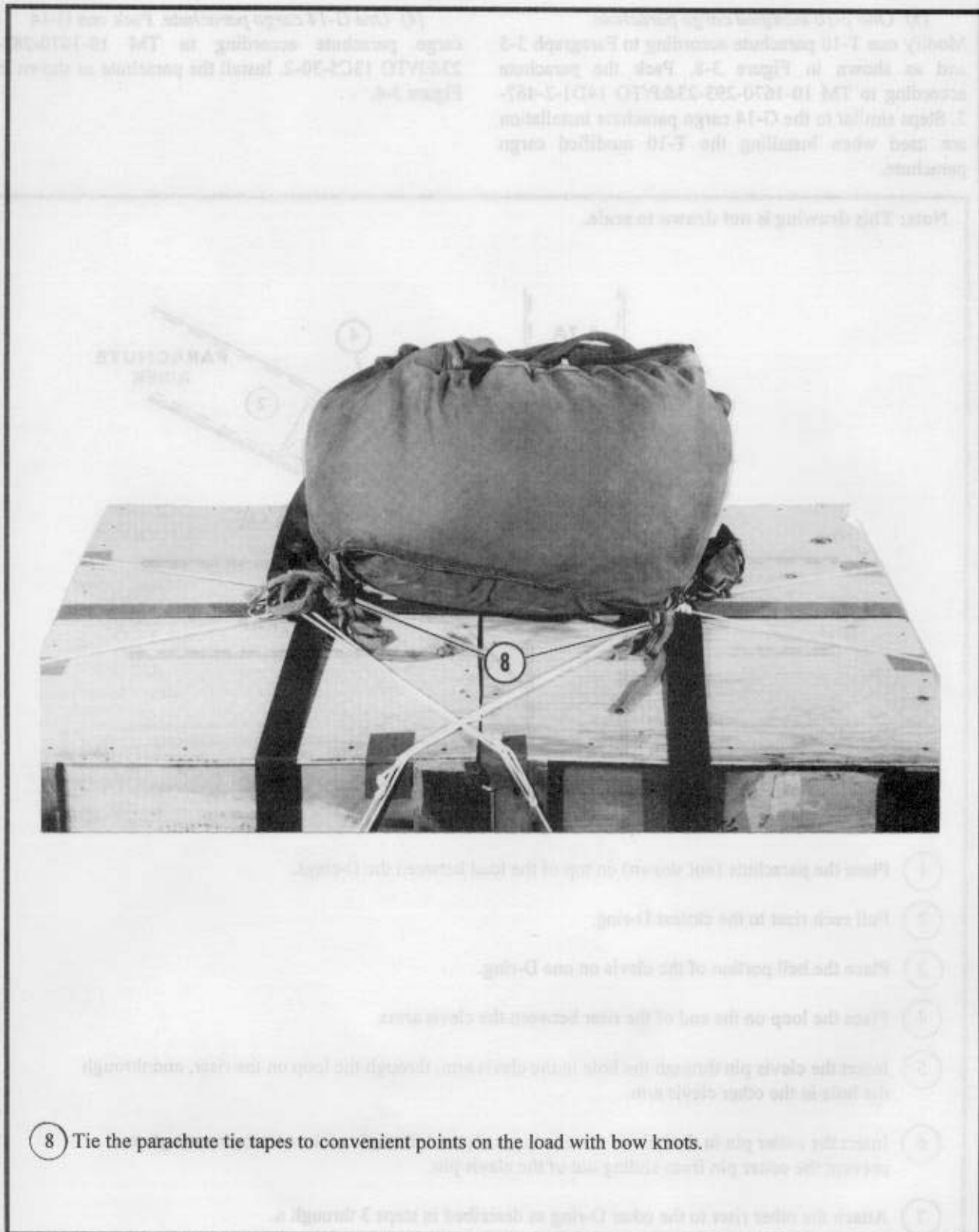

8 Tie the parachute tie tapes to convenient points on the load with bow knots.

Figure 3-4. One G-14 cargo parachute installed (continued)

b. High-Velocity Loads. The parachutes that can be used to rig an A-7A load for high-velocity airdrop are described here.

(1) *One 68-inch pilot parachute.* Pack and install one 68-inch pilot parachute as described in paragraph 3-4a(1).

(2) *Three 68-inch pilot parachutes.* Pack and install three 68-inch pilot parachutes as described in paragraph 3-4a(2).

(3) *One 12-foot, high-velocity cargo parachute.* Pack one 12-foot, high-velocity cargo parachute according to TM 10-1670-275-23&P/TO 13C5-25-2. Install the parachute as shown in Figure 3-5.

(4) *One 15-foot cargo extraction parachute.* When the 15-foot cargo extraction parachute is used as the primary parachute on a high-velocity airdrop, modify the parachute as shown in Figure 3-6. Install it as shown in Figure 3-7.

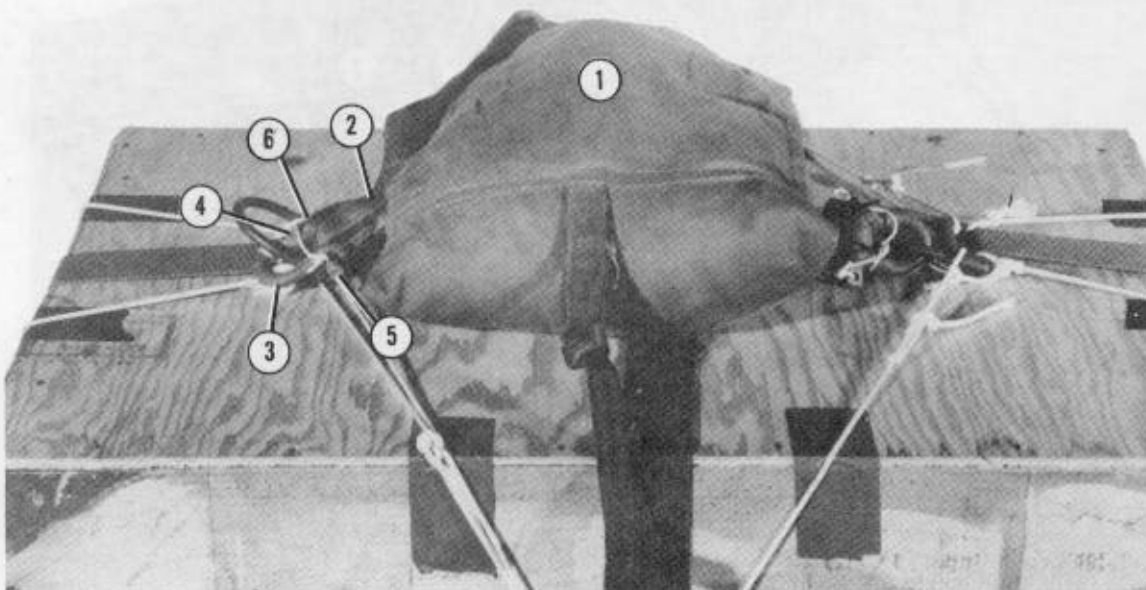

- ① Center the parachute on top of the load between the D-rings.
- ② Pull each riser to the closest D-ring.
- ③ Place the bell portion of a clevis on one D-ring.
- ④ Place the loop on the end of the riser between the clevis arms.
- ⑤ Insert the clevis pin through the hole in the clevis arm, through the loop on the riser, and through the hole in the other clevis arm.
- ⑥ Insert the cotter pin in the hole of the clevis pin. Spread the ends of the cotter pin enough to prevent the cotter pin from sliding out of the clevis pin.

Figure 3-5. One 12-foot, high-velocity parachute installed

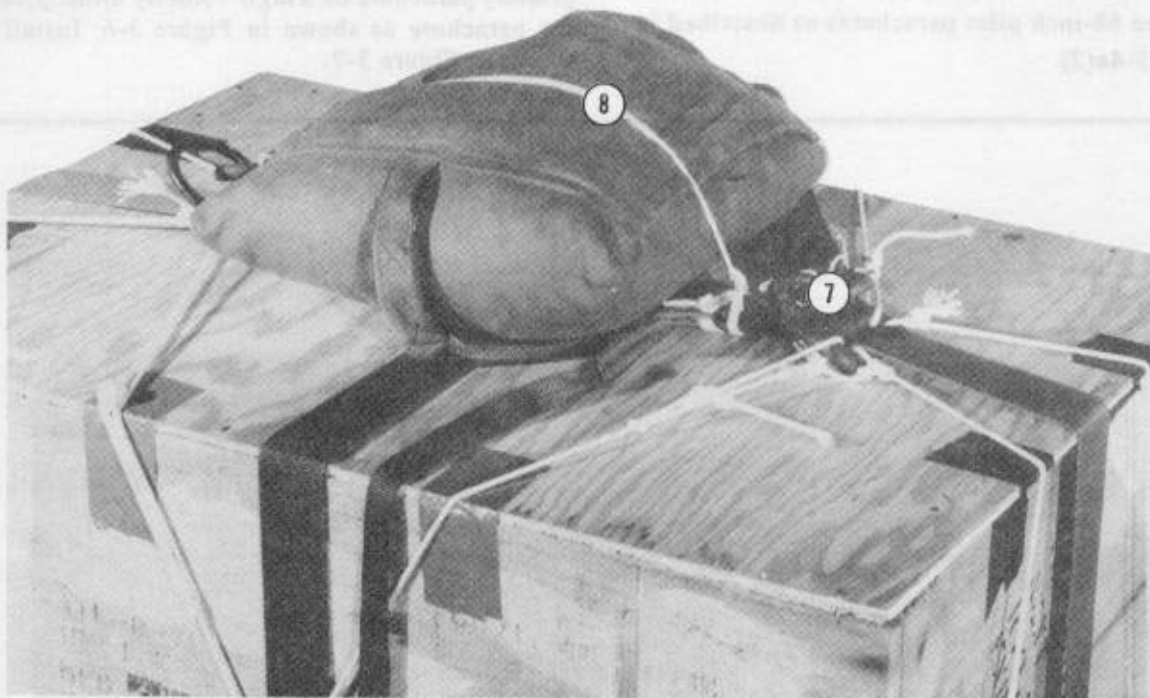

- ⑦ Attach the other riser to the other D-ring as described in steps 1 through 6.
- ⑧ Tie a length of type I, 1/4-inch cotton webbing on one side of the parachute at a convenient point. Pass the free end of the type I, 1/4-inch cotton webbing over the parachute, and tie it to a convenient point.

Figure 3-5. One 12-foot, high-velocity parachute installed (continued)

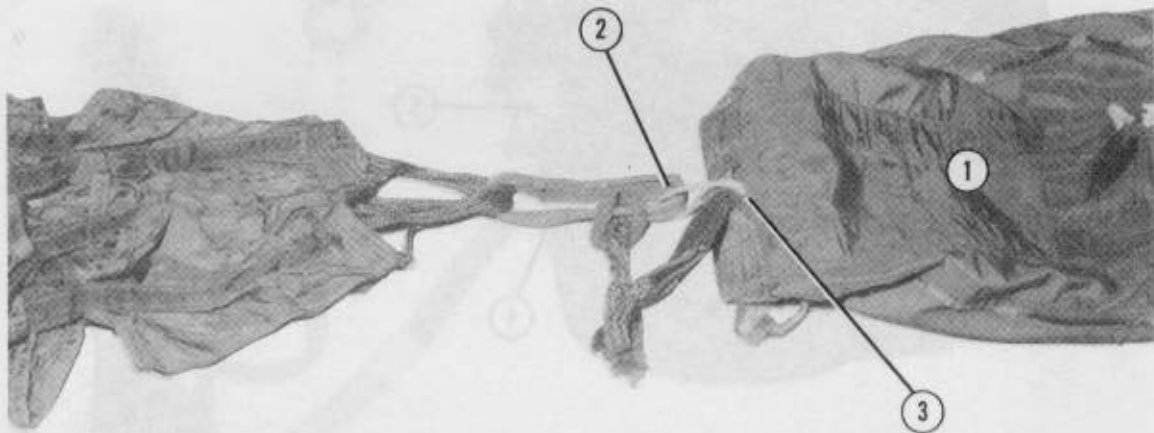

- ① Invert the 15-foot cargo extraction parachute deployment bag.
- ② Pass a 14-inch length of type III nylon cord through the bridle loop of the 15-foot extraction parachute. Even the ends of the cord.
- ③ Pass both ends of the type III nylon cord through the hole in the top of the deployment bag.

Figure 3-6. A 15-foot cargo extraction parachute modified.

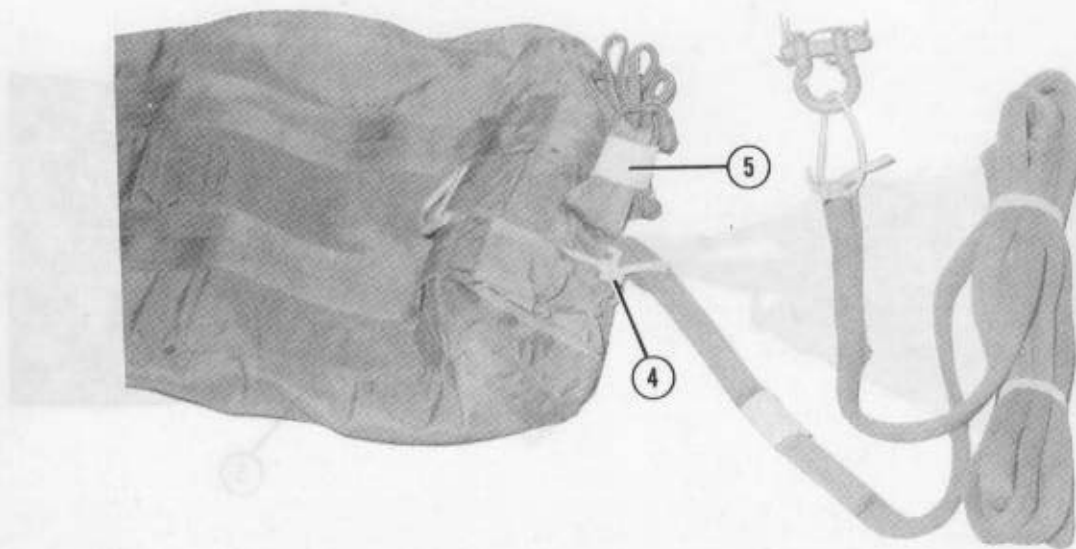

- ④ Pass one end of the type III nylon cord through the break cord attaching loop in the end of the static line. Tie the ends of the type III nylon cord together with a surgeon's knot and a locking knot. Tie an overhand knot in each end.
- ⑤ S-fold the pendulum line, and tape the folds together.

Figure 3-6. A 15-foot cargo extraction parachute modified (continued)

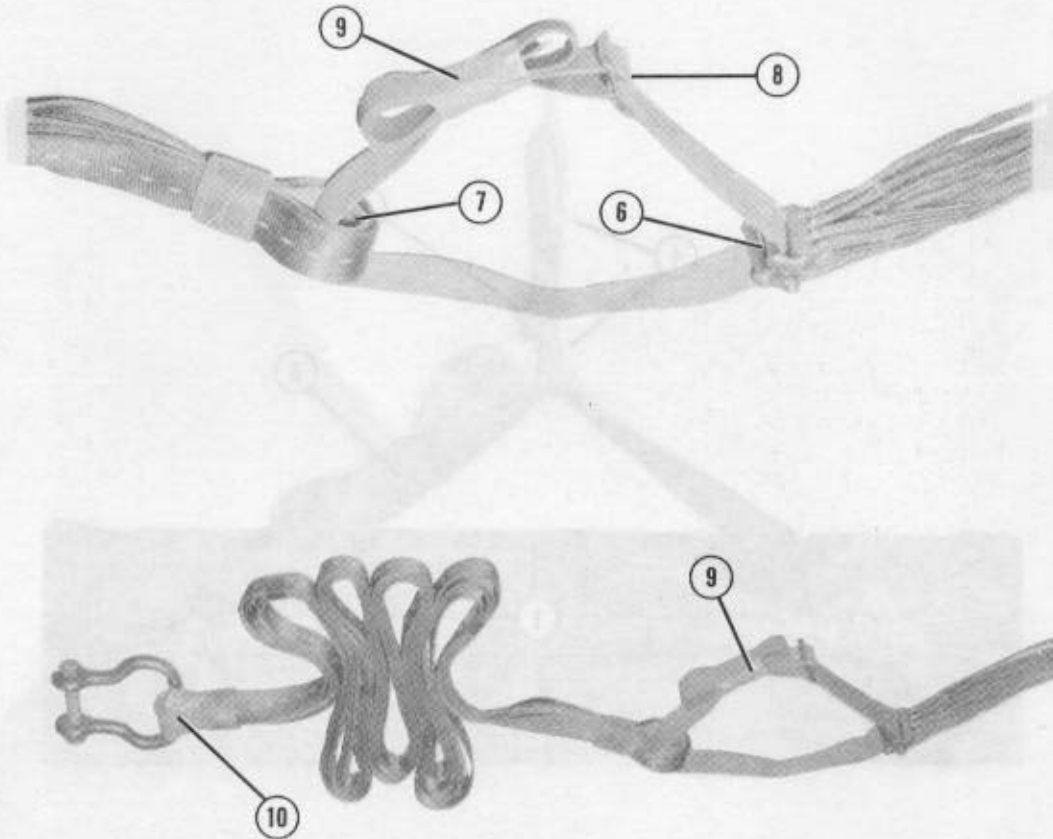

- ⑥ Remove the extraction line and the 36-inch adapter web from the parachute connector links. Pass the free end of a 60-inch nylon webbing strap (shear strap) through the suspension line L-bar connector links.
- ⑦ Pass the free end of the shear strap through one end of a 20-foot (2-loop), type XXVI nylon webbing sling.
- ⑧ Fasten the shear strap with the friction adapter, and pull the end of the strap until a 12-inch loop is formed.
- ⑨ Fold the excess strap, and tape the folds to the strap.
- ⑩ Place a 3/4-inch cargo suspension clevis on the free end of the 20-foot sling. Replace the bolt and nut. Tape the clevis to the sling.

Figure 3-6. A 15-foot cargo extraction parachute modified (continued)

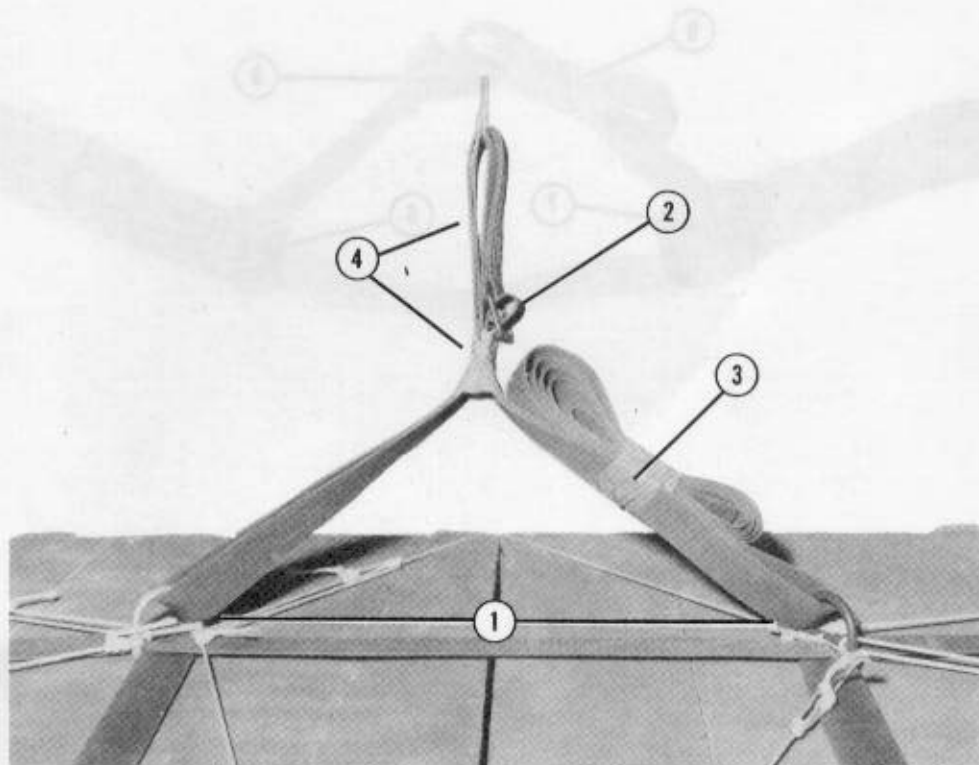

- ① Pass the free end of an A-7A strap through the two D-rings on top of the load.
- ② Fasten the strap with the friction adapter. Pull the end of the strap through the friction adapter until the double length of the strap is 24 inches long.
- ③ Fold the excess strap. Secure the folds to the strap with tape or type I, 1/4-inch cotton webbing.
- ④ Pull the two plies of the strap upward. Form a 6-inch loop in the center of the strap, and tape the plies of the strap together below the loop.

Figure 3-7. One modified 15-foot cargo extraction parachute installed

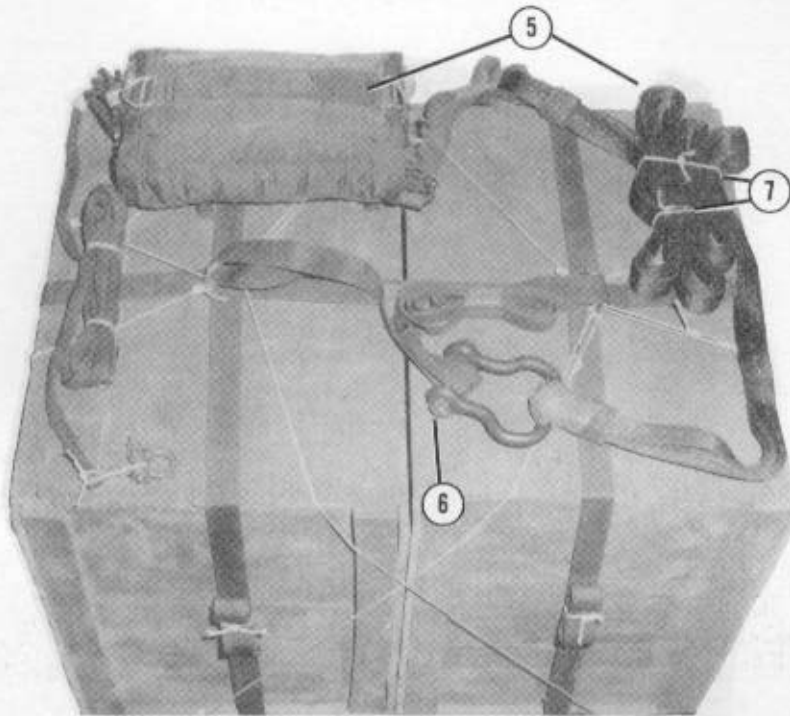

- ⑤ **Modify the 15-foot cargo extraction parachute as shown in Figure 3-6. Place the 15-foot cargo parachute and the 20-foot sling on top of the load.**
- ⑥ **Place the loop formed in step 4 on the bolt of the cargo suspension clevis on the end of the 20-foot sling. Replace the nut.**
- ⑦ **Fold the 20-foot sling, and tie the folds in place with lengths of type 1, 1/4-inch cotton webbing.**

Figure 3-7. One modified 15-foot cargo extraction parachute installed (continued)

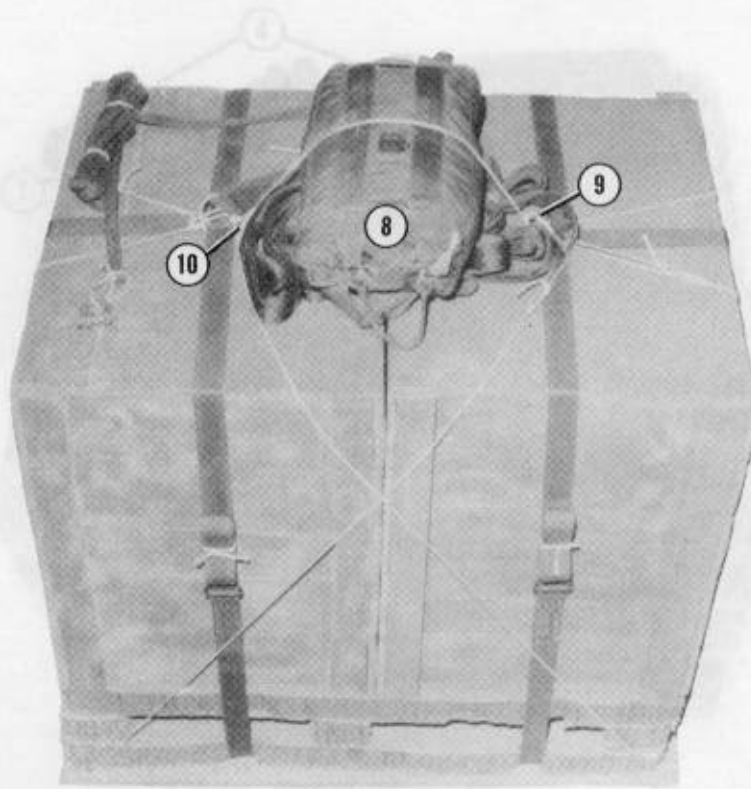

- ⑧ Center the sling and the parachute on the load.
- ⑨ Tie one end of a length of type I, 1/4-inch cotton webbing to a convenient point on the load.
- ⑩ Pass the free end of the type I, 1/4-inch cotton webbing over the parachute. Pull the webbing tight, and tie the free end to a convenient point on the load.

Figure 3-7. One modified 15-foot cargo extraction parachute installed (continued)

3-5. Modifying the T-10 Parachute

CAUTION

T-10 parachutes or components thereof that have been converted for cargo use must not be used for personnel parachutes.

The T-10 personnel parachute may be used as the recovery parachute on container loads weighing at least 90 pounds but not more than 500 pounds. However, the T-10 parachute must be modified to be used on container loads. Prepare the T-10 parachute as described below:

- a. Inspect the parachute according to TM 10-1670-293-23&P/TO 14D1-2-467-2.
- b. Construct the riser harness as shown in Figure 3-8, steps 1 through 6.
- c. Modify the deployment bag as shown in Figure 3-8, steps 7, 12, and 13.
- d. Remove the static line snap assembly as shown in Figure 3-8, step 8.
- e. Modify the static line as shown in Figure 3-8, steps 9 and 10.
- f. Modify the canopy as shown in Figure 3-8, steps 14 and 15.
- g. Attach the riser harness as shown in Figure 3-8, step 16.
- h. Pack the parachute according to TM 10-1670-293-23&P/TO 14D1-2-467-2.
- i. Fold and secure the static line as shown in Figure 3-8, steps 17, 18, and 19.

Note: This drawing is not drawn to scale.

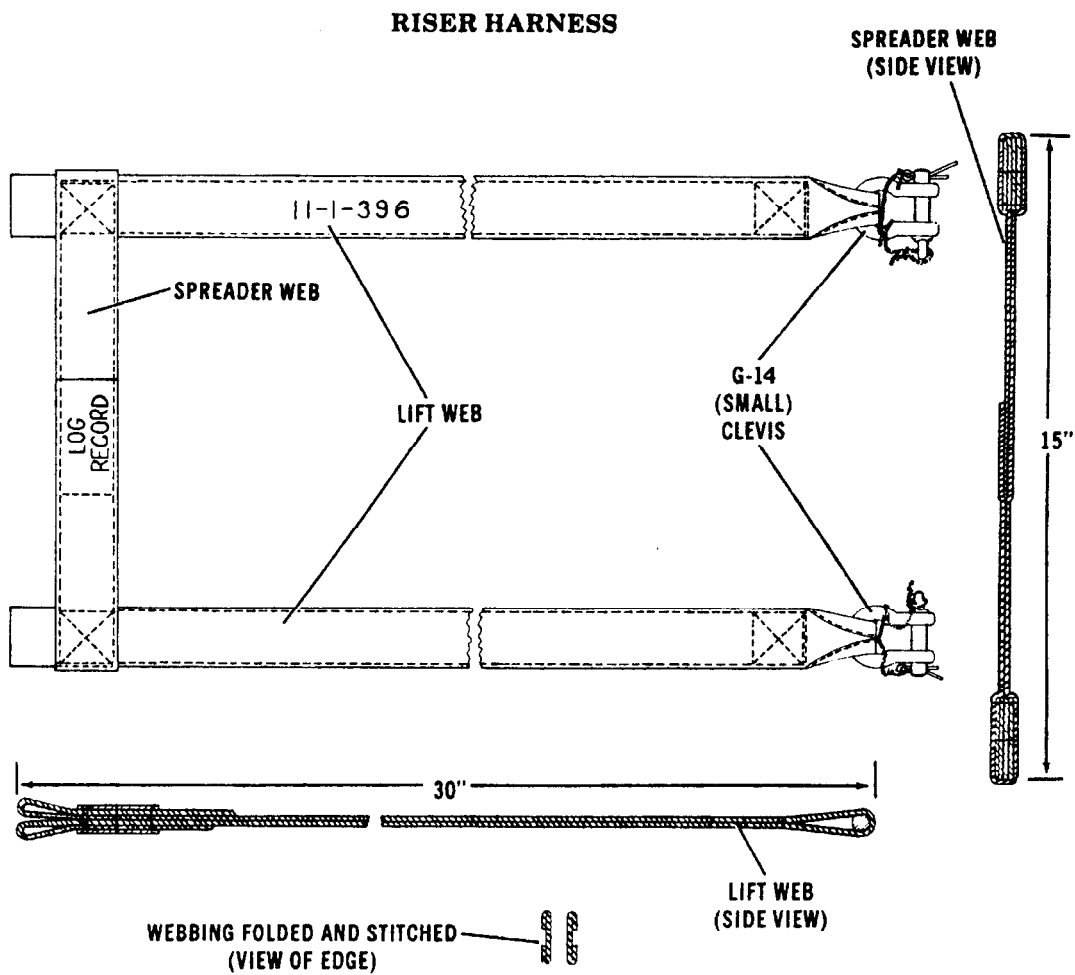

Step:

1. Use type VIII nylon webbing.
2. Use size 3, nylon thread.
3. Follow TM 10-1670-298-20&P for stitching instructions.
4. Form the T-10 cargo parachute riser harness as shown in the diagram above.
5. Form a pocket in the center of the spreader web as shown in the diagram above. Attach the prepared log record book to the spreader web pocket.
6. Attach the two G-14 clevises.

Figure 3-8. T-10 parachute modified

Note: These drawings are not drawn to scale.

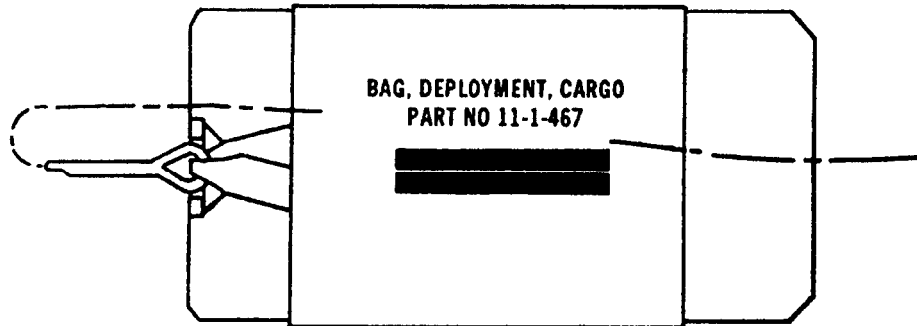

Step:

7. Cover or black out the data block on the deployment bag flap. Stencil on the bag flap with ink (color number 15102, MIL-I-6903C) as close as possible to the original lettering the following:

BAG, DEPLOYMENT, CARGO
PART NO 11-1-467

Note: The lettering must be at least 1/2-inch high.

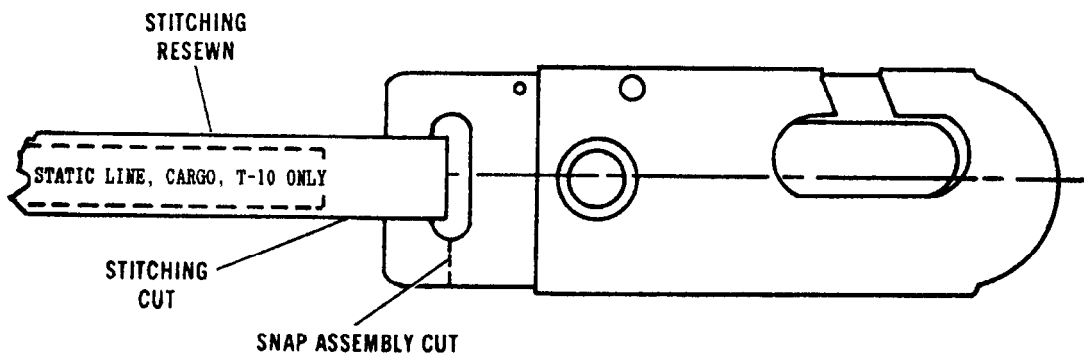

8. Remove the static line snap assembly from the static line with bolt cutters.

9. Cut the stitching on the inside of the static line loop back 1/2 inch from the end. Start 2 inches below the cut stitching, and sew the edge of the static line 2 inches toward the cut stitching and across the static line. Sew the edge of the static line 2 inches on the other side.

10. Attach a G-14 clevis to the loop formed in step 9.

11. Using 1/2-inch high lettering, stencil the following words 1 inch below the G-14 clevis attaching loop: STATIC LINE, CARGO, T-10 ONLY. The lettering must be done with strata blue parachute ink.

Figure 3-8. T-10 parachute modified (continued)

Note: These drawings are not drawn to scale.

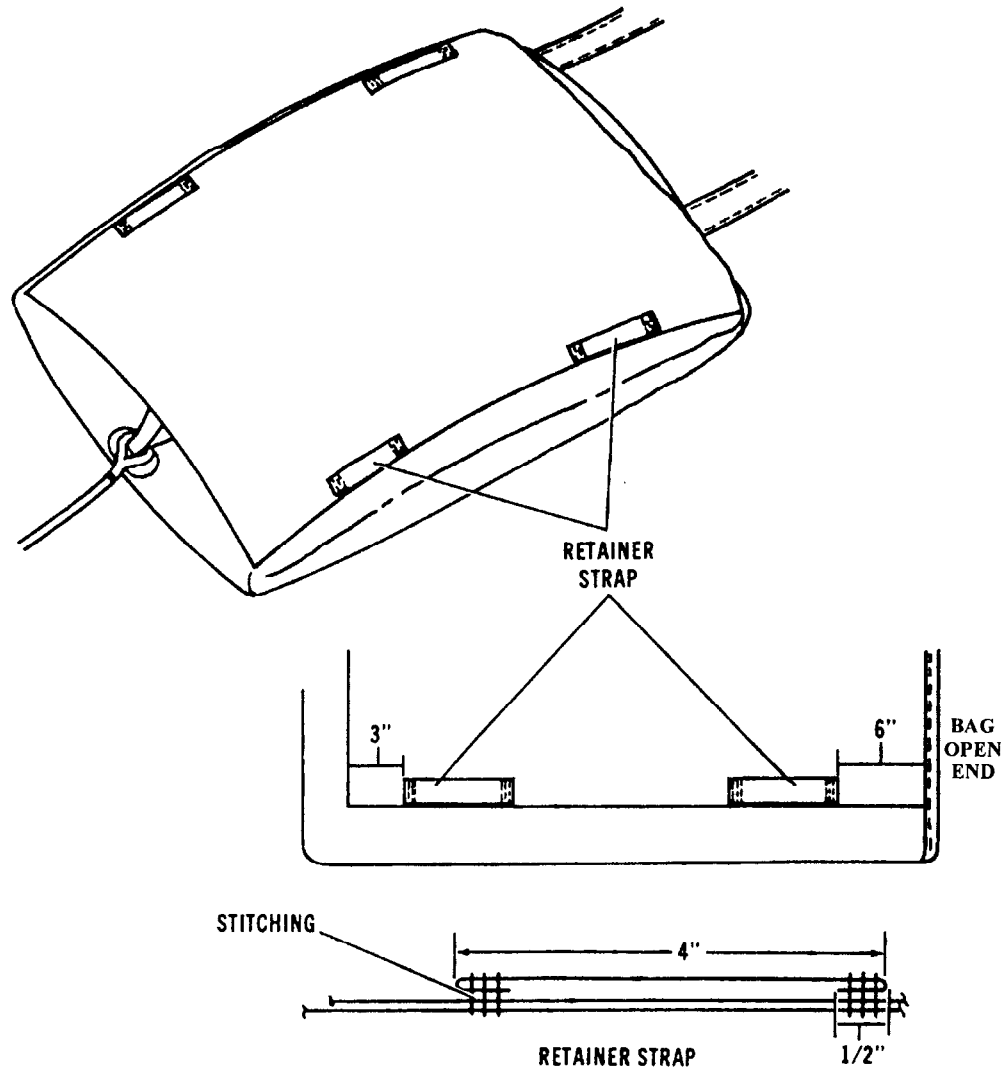

Step:

12. Cut a 5 inch length of 1-inch, type II cotton webbing, and wax the ends.

Note: If 1-inch, type II cotton webbing is not available, 1-inch, type III nylon webbing may be substituted.

13. Make a 1/2-inch turn-under on each end of the webbing, and position the webbing as shown with the turn-unders facing down. Secure the strap by making three rows of stitching across each strap end according to TM 10-1670-276-23&P/TO 13C5-29-2 and TM 10-1670-201-23/TO 13C-1-41.

Figure 3-8. T-10 parachute modified (continued)

Note: This drawing is not drawn to scale.

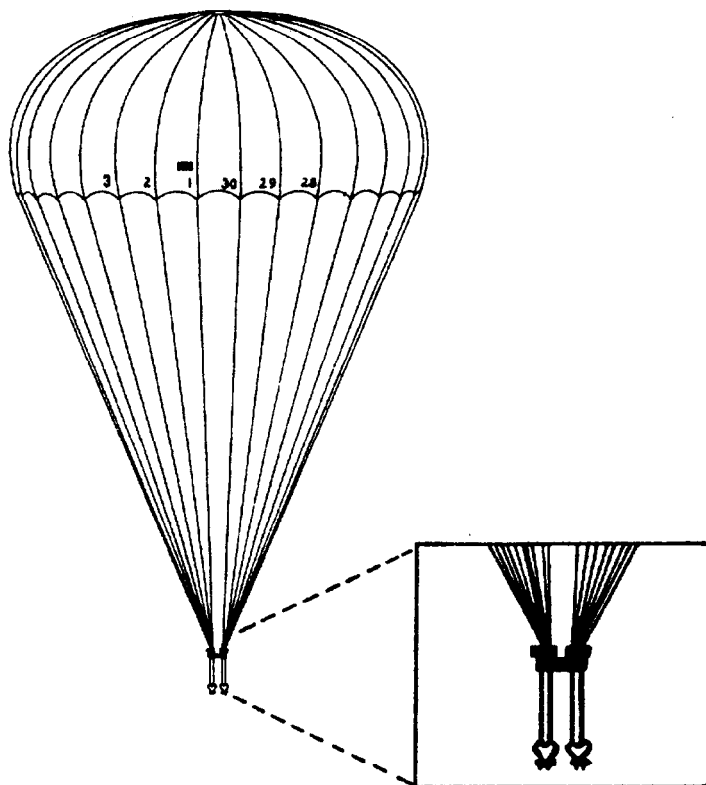

Step:

14. Cover or black out the data block (except serial number) on number 1 gore and 15 gore of the parachute canopy. Stencil on the canopy (as close as possible to the original lettering) the following:

CANOPY, CARGO, NYLON
PART NUMBER 11-1-466

15. Remove the personnel harness from the T-10 parachute.
16. Install the riser harness as follows:
 - a. Attach suspension lines 1 through 8 to the left front riser loop with an L-bar connector link.
 - b. Attach suspension lines 9 through 15 to the left rear riser loop with an L-bar connector link.
 - c. Attach suspension lines 16 through 22 to the right rear riser loop with an L-bar connector link.
 - d. Attach suspension lines 23 through 30 to the right front riser loop with an L-bar connector link.

Figure 3-8. T-10 parachute modified (continued)

Note: This drawing is not drawn to scale.

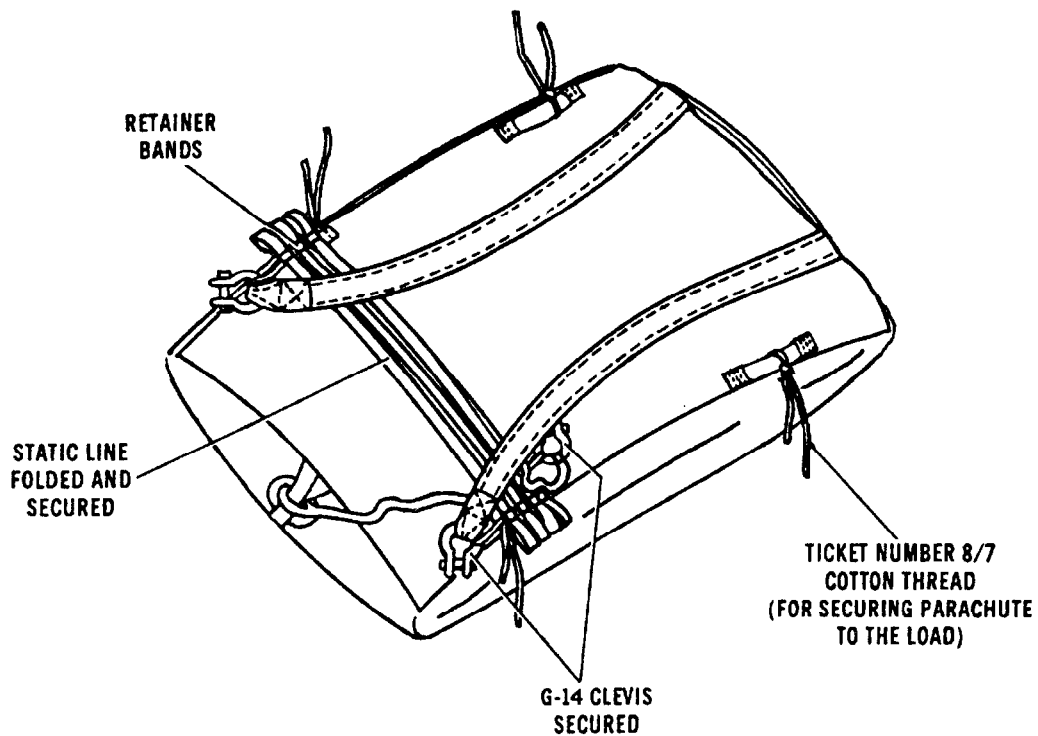

Step:

17. Fold the static line across the deployment bag. Secure the folds to the top retainer straps with retainer bands.
18. Secure the static line clevis with a retainer band or ticket number 8/4 cotton thread.
19. Secure each G-14 clevis attached to the riser harness to the retainer straps with ticket number 8/4 cotton thread to store the parachute.

Note: When installing the parachute on the load, secure the parachute to convenient points on the load with ticket number 8/7 cotton thread attached to each retainer strap.

Figure 3-8. T-10 parachute modified (continued)

Table 3-2. Equipment required for modifying the T-10 parachute

National Stock Number	Item	Quantity
1670-00-590-9909	Bag, deployment	1
1670-01-247-7151	Canopy, 35-ft diam, T-10C	1
1670-00-568-0323	Band, retainer	As required
4030-00-678-8560	Shackle, 3/8-in diam (G-14 clevis)	2
8310-00-917-3944	Thread, cotton, ticket number 8/4	As required
8310-00-917-3945	Thread, cotton, ticket number 8/7	As required
8310-00-267-3027	Thread, nylon, size 3, OD	As required
	or	
8310-00-248-9714	Thread, nylon, size 3, NT	As required
	Webbing:	
8305-00-268-2411	Cotton, 1/4-in, type I	As required
8305-00-281-3315	Cotton, 1-in, type II	As required
	or	
8305-01-062-7050	Nylon, 1-in, type III	As required
8305-00-261-8585	Nylon, type VIII, OD	As required
	or	
8305-00-263-3591	Nylon, type VIII, NT	As required

CHAPTER 4 RIGGING TYPICAL A-7A CONTAINERS

Section I LOW-VELOCITY AIRDROP FROM PARATROOP DOOR

4-1. Description of Load

Typical A-7A loads are rigged for low-velocity airdrop from a paratroop door of an aircraft. Typical loads may include rations, small equipment, water cans, or other supplies. Items should be padded and/or placed in boxes to prevent damage during airdrop. This load must not exceed 500 pounds, excluding the weight of the parachute. The minimum weight will vary according to the parachute used. The maximum dimensions for this load are 48 by 30 by 66 inches including parachute. When the load is dropped, the largest dimension will be placed in an upright position in the door. The parachute will be on top of or on the

side located inside the aircraft. When the weight of the load exceeds 350 pounds, three trained designated pushers will assist the jumpmaster in pushing the load out.

4-2. Positioning Straps

Position straps as shown in Figure 4-1. When two straps are used, a piece of type III nylon cord needs to be placed parallel to the bottom strap. When positioning straps, make sure the oversized portion of the metal frame on the friction adapter is up.

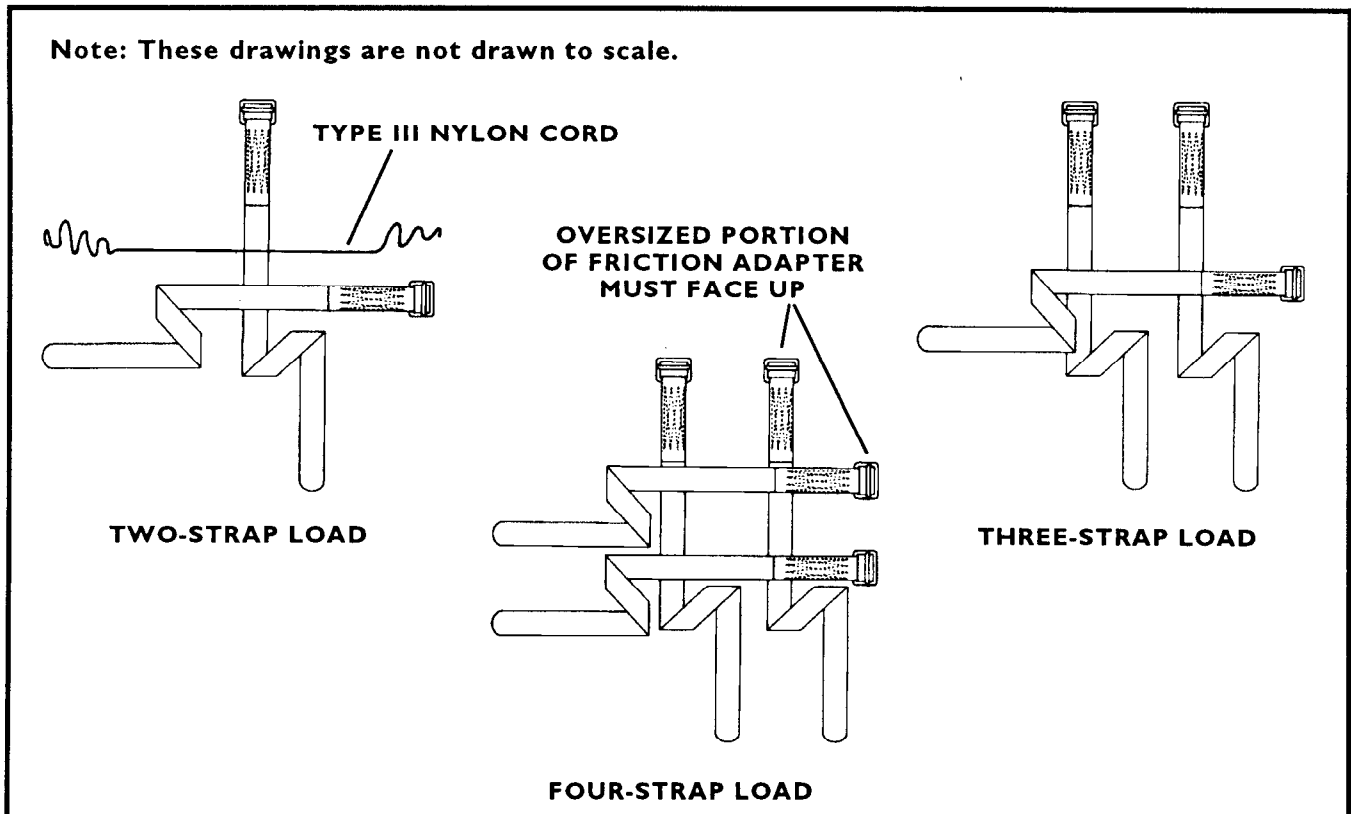
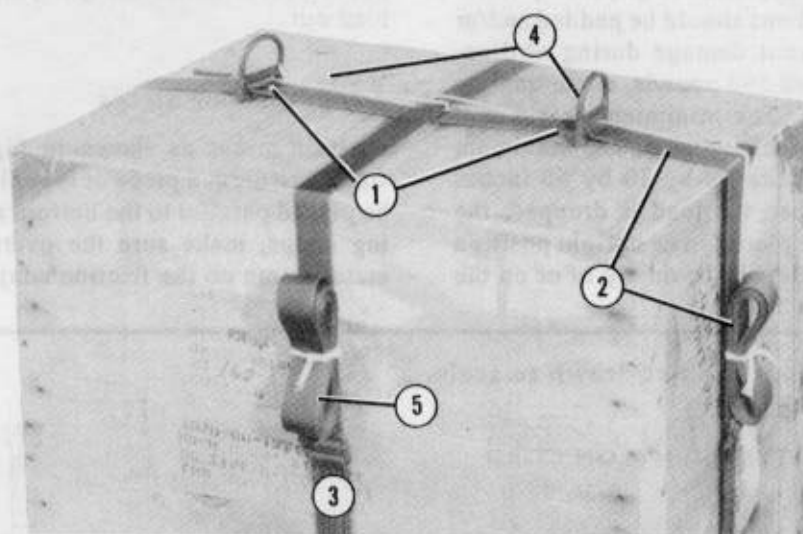

Figure 4-1. A-7A straps positioned

4-3. Positioning Load and Securing Straps

Center the equipment on the straps. If needed, honeycomb can be placed under the equipment. Secure the straps as shown in Figure 4-2 for the two-strap load, Figure 4-3 for the three-strap load, and Figure 4-4 for the four-strap load.

Note: When the 68-inch pilot parachute will be used, only one D-ring is installed at the intersection of straps.



- ① Using the strap with the type III nylon cord beside it, route the strap through the rectangular portion of the two D-rings.
- ② Route the strap with D-rings on it over the load and route it through the friction adapter. Center the D-rings on top of the load 12 inches apart, and apply tension to the strap.
- ③ Route the other strap over the load and route it through the friction adapter. Apply tension to the strap.
- ④ Route one end of the type III nylon cord over the top of the load. Tie a knot around the first D-ring and tie the running end of the type III nylon cord to the other D-ring. Repeat step for the other side. Tie knots in the running ends and trim the excess to 2 inches.
- ⑤ Fold and secure the excess straps according to Figure 1-3.

Figure 4-2. Two-strap load positioned and secured

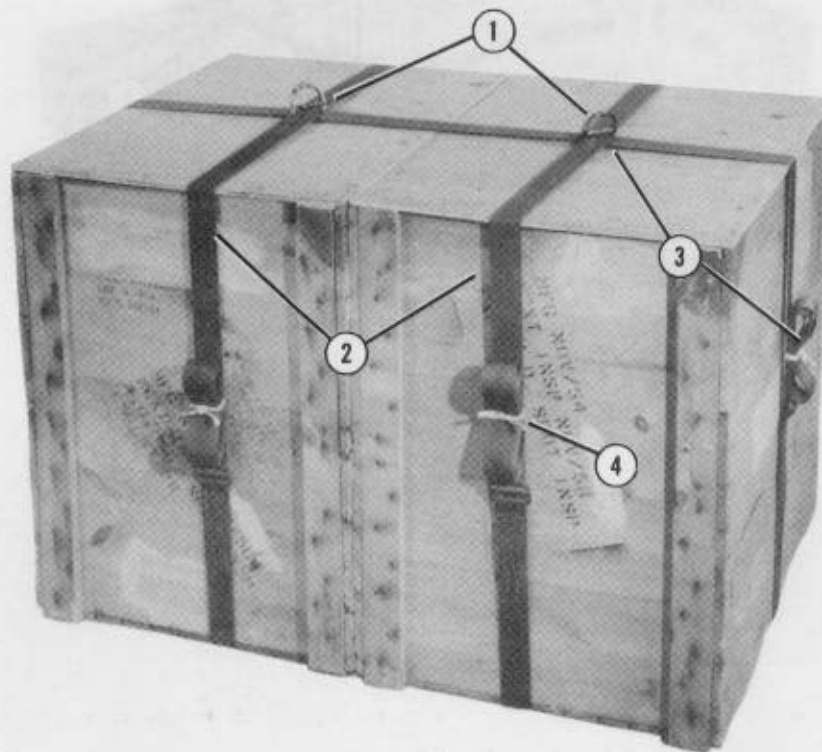

- ① Place the two straps as shown above. Route each strap through the rectangular portion of a D-ring.
- ② Route the two straps with D-rings over the load and through the friction adapters. Center the D-rings on top of the load, then apply tension to the straps.
- ③ Route the third strap through both rectangular portions of the D-rings on the other two straps as shown above. Route the end through the friction adapter. Apply tension to the strap.
- ④ Fold and secure the excess straps according to Figure 1-3.

Figure 4-3. Three-strap load positioned and secured

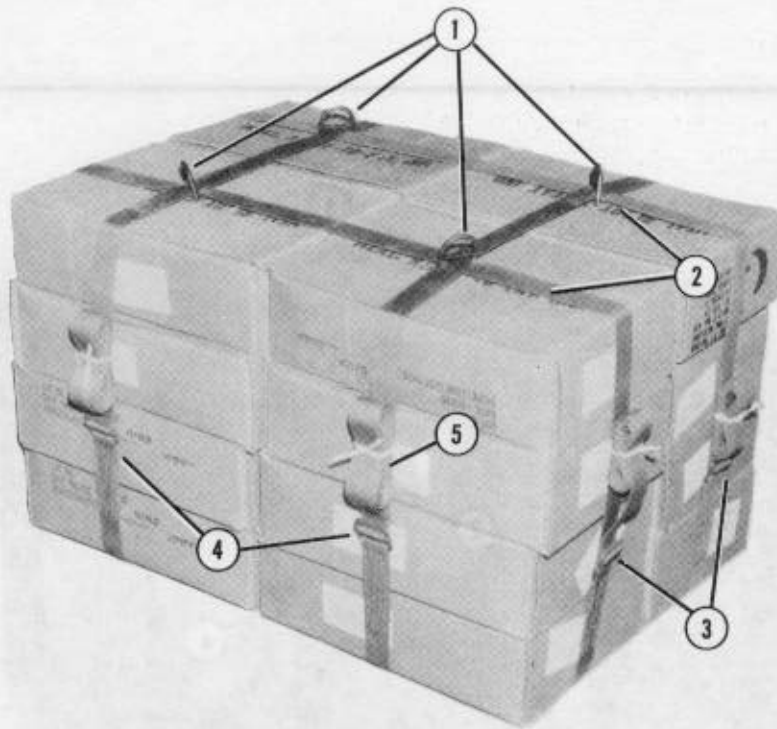

- ① Use two straps and four D-rings. Route each strap through the rectangular portion of two D-rings. Route the straps over the load and through the friction adapters. Slide the D-rings to the top of the load.
- ② Use two straps for the side. Route one through the rectangular portion of the rear set of D-rings and the other through the front set.
- ③ Route the two side straps through the friction adapters and apply tension to the straps.
- ④ Apply tension to the rear straps.
- ⑤ Fold and secure excess straps according to Figure 1-3.

Figure 4-4. Four-strap load positioned and secured

4-4. Installing Parachute

Install a 68-inch pilot parachute, a T-10 modified cargo, or a G-14 cargo parachute on the load according to Chapter 3.

4-5. Marking Rigged Load

Mark the rigged load according to Chapter 1. Compute the rigged load data. See Figure 4-5 for rigged load data for two-, three-, and four-strap loads.

4-6. Equipment Required

Use the equipment listed in Table 4-1 to rig a four-strap load for low-velocity airdrop as shown in Figure 4-5.

CAUTION

Make the final inspection required by Chapter 1 before the load leaves the rigging site. If the load includes hazardous material as defined in AFJMAN 24-204/TM 38-250, complete Shipper's Declaration for Dangerous Goods form.



RIGGED LOAD DATA

Container	Parachute	Weight (without parachute)
A-7A (two strap)	One 68-inch	30 - 50 pounds
	Three 68-inch	51 - 200 pounds
	T-10 modified	90 - 300 pounds
	G-14	200 - 300 pounds
A-7A (three strap)	One 68-inch	30 - 50 pounds
	Three 68-inch	51 - 200 pounds
	T-10 modified	90 - 400 pounds
	G-14	200 - 400 pounds
A-7A (four strap) (shown)	One 68-inch	30 - 50 pounds
	Three 68-inch	51 - 200 pounds
	T-10 modified	90 - 500 pounds
	G-14	200 - 500 pounds

Figure 4-5. Typical four-strap load rigged for low-velocity paratroop door airdrop

Table 4-1. Equipment required for rigging the four-strap A-7A load for low-velocity paratroop door airdrop

National Stock Number	Item	Quantity
4020-00-240-2146 8135-00-664-6958	Cord, nylon, type III, 550-lb Cushioning material, packaging, cellulose wadding	As required As required
1670-00-753-3928	Pad, energy-dissipating, honeycomb	As required
1670-00-999-2658	Parachute, cargo, G-14	1
1670-00-251-1153	Sling assembly, cargo, airdrop, A-7A	1
7510-00-266-6710	Tape, masking, 2-in	As required
	Webbing:	
8305-00-268-2411	Cotton, 1/4-in, type I	As required
8305-00-082-5752	Nylon, tubular, 1/2-in	As required

Section II

LOW-VELOCITY AIRDROP FROM RAMP

4-7. Description of Load

A-7A containers are rigged for drop off the ramp of an aircraft. The load is rigged the same as paratroop door drops but it must have a skid board attached. The skid board must be 2 inches wider than the roller conveyors. On Air Force aircraft, the minimum width of the skid board is 42 inches. The weight range for ramp drops is 200 to 500 pounds without the weight of the parachute. The T-10 modified cargo or G-14 cargo parachute is the only parachute used on low-velocity ramp drops. Table 3-1 gives the weight ranges.

4-8. Preparing Skid Board

Prepare a skid board as shown in Figure 4-6.

4-9. Placing Honeycomb and Positioning Straps

Place the honeycomb on the skid board as shown in Figure 4-7. Position the straps the same as shown in Section I of this chapter.

4-10. Positioning Load and Securing Straps

Position the load and secure the straps as shown in Section I of this chapter.

4-11. Securing Skid Board

Secure the skid board to a three-strap load as shown in Figure 4-8. Adapt the procedures in Figure 4-8 for a two-strap load. Secure the skid board to a four-strap load as shown in Figure 4-9.

- Notes: 1. This drawing is not drawn to scale.
 2. All dimensions are given in inches.

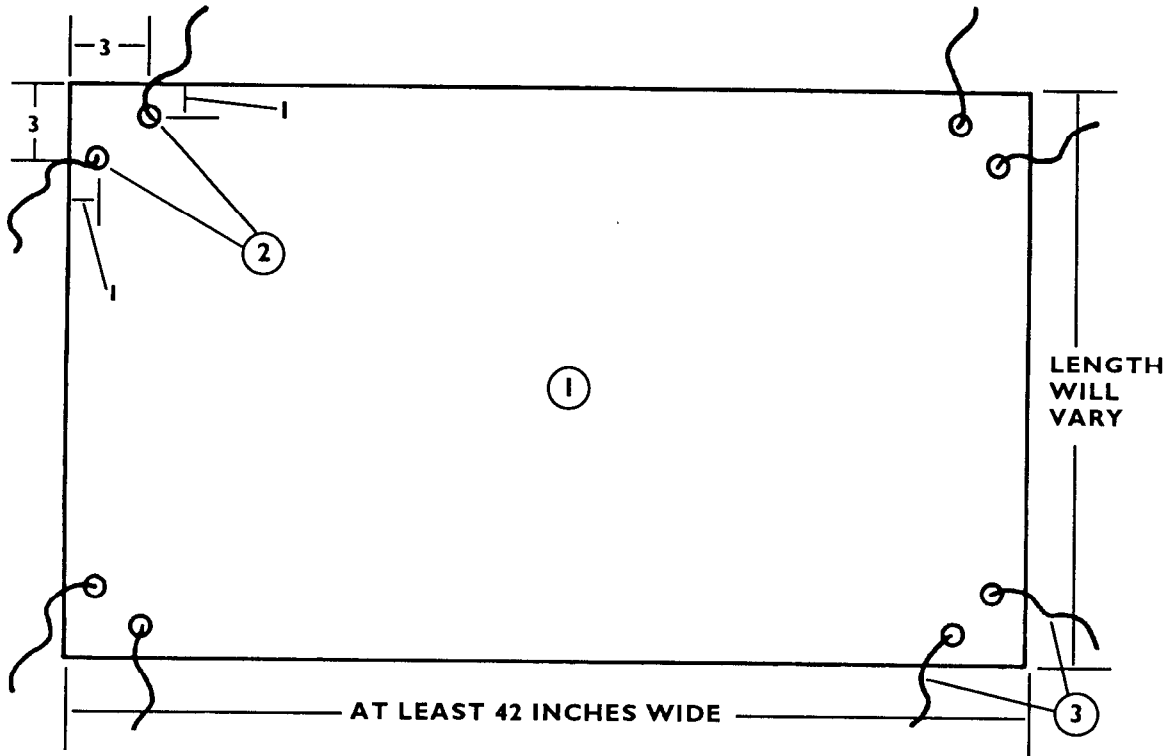

- ① Place a 1/2- or 3/4-inch piece of plywood on a flat surface.
- ② Drill eight 1/2-inch holes as shown above.
- ③ Pass a length of type III nylon cord through each set of holes. The length of the cord will vary according to the height of the load. If type III nylon cord is not available, use 1/2-inch tubular nylon webbing.

Figure 4-6. Skid board prepared

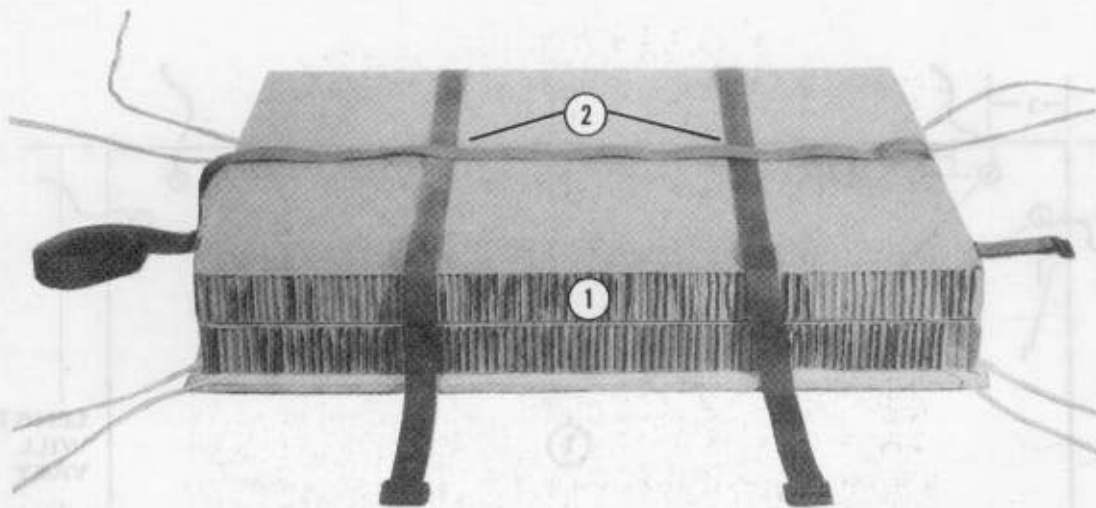

- ① Cut two pieces of honeycomb at least the size of the base of the load. Honeycomb may be omitted if cushioning is not needed. Center the honeycomb on the skid board. Glue the honeycomb to the skid board, if needed .
- ② Position straps as described in Section I of this chapter. The straps may be positioned under the honeycomb, if desired. The three-strap load is shown in this figure.

Figure 4-7. Honeycomb placed and straps positioned on skid board

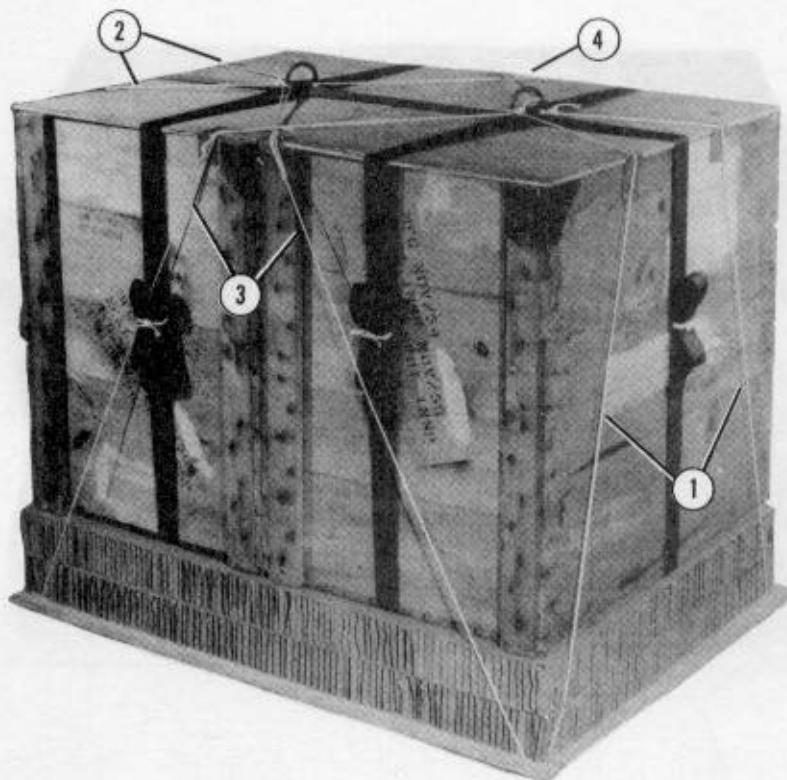

- ① Tie the two lengths of type III nylon cord on the right side of the skid board to the D-ring on the top right side of the load.
- ② Repeat step 1 for the left side using the left D-ring.
- ③ Tie the front right length of type III nylon cord to the D-ring on the top left side of the load using a trucker's hitch knot and an overhand knot in the running end. Repeat step for the front left length of cord.
- ④ Repeat step 3 for the rear side of the load.

Figure 4-8. Skid board secured to three-strap load

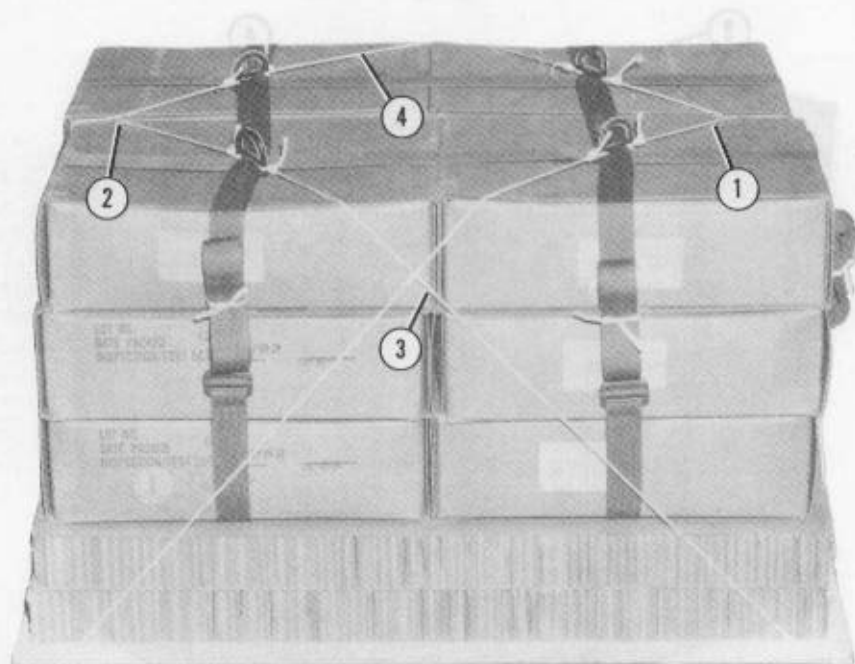

- ① On the right side of the skid board, tie the front right length of type III nylon cord to the rear right D-ring. Tie the rear right length of cord to the front right D-ring.
- ② Repeat step 1 on the left side using the two D-rings on the left side.
- ③ On the front of the skid board, cross the right length of type III nylon cord over to the front left D-ring. Tie it with a trucker's hitch knot and a knot in the running end. Repeat for left side length of cord using the right front D-ring.
- ④ Repeat step 3 using rear D-rings and rear lengths of cord.

Figure 4-9. Skid board secured to four-strap load

4-12. Installing Parachute

Install a T-10 modified cargo or a G-14 cargo parachute on the load according to Chapter 3.

4-13. Marking Rigged Load

Mark the rigged load according to Chapter 1. Compute the rigged load data.

4-14. Equipment Required

Use the equipment listed in Table 4-2 to rig a four-strap load for low-velocity ramp airdrop as shown in Figure 4-10.

CAUTION

Make the final inspection required by Chapter 1 before the load leaves the rigging site. If the load includes hazardous material as defined in AFJMAN 24-204/TM 38-250, complete Shipper's Declaration for Dangerous Goods form.

**RIGGED LOAD DATA**

Weight (without parachute)	200 - 500 pounds
Parachute	G-14

Figure 4-10. Four-strap A-7A load rigged for low-velocity ramp airdrop

Table 4-2. Equipment required for rigging the four-strap A-7A load for low-velocity ramp airdrop

National Stock Number	Item	Quantity
4020-00-240-2146	Cord, nylon, type III, 550-lb	As required
8135-00-664-6958	Cushioning material, packaging, cellulose wadding	As required
1670-00-753-3928	Pad, energy-dissipating, honeycomb	As required
1670-00-999-2658	Parachute, cargo, G-14	1
5530-00-129-7777	Plywood: 1/2- by 48- by 96-in	1 sheet
5530-00-128-4981	<u>or</u> 3/4- by 48- by 96-in	1 sheet
1670-00-251-1153	Sling assembly, cargo, airdrop, A-7A	1
7510-00-266-6710	Tape, masking, 2-in	As required
8305-00-268-2411	Webbing: Cotton, 1/4-in, type I	As required
8305-00-082-5752	Nylon, tubular, 1/2-in	As required

Section III

HIGH-VELOCITY AIRDROP

4-15. Description of Load

A-7A loads rigged for high-velocity airdrop are rigged in a similar manner to low velocity. Three layers of honeycomb and a skid board are required for paratroop door or ramp drop. This load must not exceed 500 pounds, excluding the weight of the parachute.

4-16. Preparing Drop Items

Place items in a container so that the A-7A straps can hold the items safely together during exit and descent. Items dropped at high velocity will impact at a high rate of speed; therefore, sensitive items cannot be dropped using this method.

4-17. Preparing Skid Board

Prepare the skid board using 1/2- or 3/4-inch plywood in the same manner as in Section II of this chapter. The

skid board will be at least the size of the base of the load. When the load is being ramp dropped, the skid board will be at least the width of the distance from the outside edges of the two conveyors on the aircraft floor. For C-130 and C-141 aircraft, 42 inches is the minimum width. Route the skid board ties in the same manner as in Section II of this chapter.

4-18. Positioning Straps

Position straps as shown in Section I of this chapter. The straps may be positioned either under or on top of the honeycomb. In this section, they are shown on top of the honeycomb.

4-19. Placing Honeycomb

Place honeycomb as shown in Figure 4-11.

- Notes: 1. This drawing is not drawn to scale.
2. Layers should be glued together.

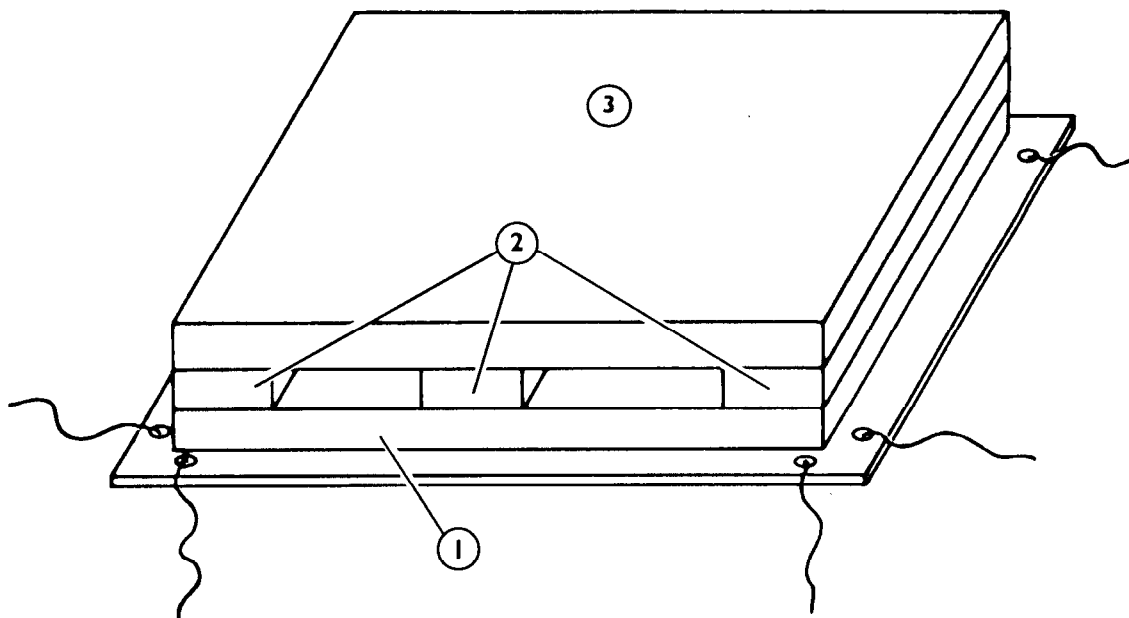

- ① Cut one piece of honeycomb at least the size of the base of the load. Center it on the skid board.
- ② Cut three pieces of honeycomb 3 inches wide and the length of the honeycomb cut in step 1. Center one piece on top of the first layer of honeycomb. Place one piece of honeycomb even with each side edge.
- ③ Cut another piece of honeycomb the same size as in step 1, and place it on top of the second layer of honeycomb.

Figure 4-11. Honeycomb placed

4-20. Securing Straps

Secure the straps according to Section I of this chapter.

4-21. Securing Skid Board

Secure the skid board to the load as shown in Section II of this chapter.

4-22. Installing Parachute

Install the parachute on the load according to Chapter 3.

4-23. Marking Rigged Load

Mark the rigged load according to Chapter 1. Compute the rigged load data.

4-24. Equipment Required

Use the equipment listed in Table 4-3 to rig a four-strap load for high-velocity airdrop as shown in Figure 4-12. ■

CAUTION

Make the final inspection required by Chapter 1 before the load leaves the rigging site. If the load includes hazardous material as defined in AFJMAN 24-204/TM 38-250, complete Shipper's Declaration for Dangerous Goods form.

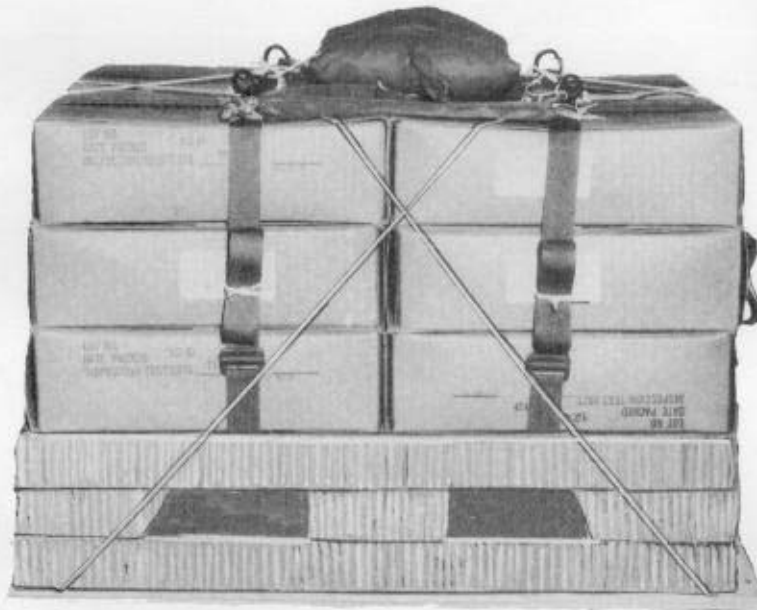

RIGGED LOAD DATA

Parachute	Weight (without parachute)
* One 68-inch	75 - 150 pounds
Three 68-inch	151 - 500 pounds
* 12-foot, high-velocity cargo (shown)	151 - 500 pounds
15-foot (modified for high-velocity)	151 - 500 pounds
* Primary parachute	

Figure 4-12. Four-strap A-7A load rigged for high-velocity ramp airdrop

Table 4-3. Equipment required for rigging the four-strap A-7A load for high-velocity ramp airdrop

National Stock Number	Item	Quantity
8040-00-273-8713	Adhesive, paste, 1-gal	As required
4020-00-240-2146	Cord, nylon, type III, 550-lb	As required
1670-00-753-3928	Pad, energy-dissipating, honeycomb	As required
1670-00-788-8666	Parachute, cargo, high-velocity, 12-ft	1
5530-00-129-7777	Plywood: 1/2- by 48- by 96-in	1 sheet
5530-00-128-4981	<i>or</i> 3/4- by 48- by 96-in	1 sheet
1670-00-251-1153	Sling assembly, cargo, airdrop, A-7A	1
7510-00-266-6710	Tape, masking, 2-in	As required
8305-00-268-2411	Webbing: Cotton, 1/4-in, type I	As required
8305-00-082-5752	Nylon, tubular, 1/2-in	As required

Section IV HAARS

4-25. Description of Load

The A-7A container load rigged for delivery by HAARS requires a 30-inch pilot parachute, an altitude sensor parachute staging unit, a 70-inch shear strap, and a G-14 cargo parachute equipped with a 53-inch HAARS deployment line. The load may be dropped from the paratroop door or ramp of an aircraft. This load may weigh 200 to 500 pounds excluding the weight of the parachute.

4-26. Rigging Load

Rig the load as a typical A-7A load. Use a skid board and at least two layers of honeycomb. Use 1/2-inch tubular nylon webbing to make the skid board ties.

Use at least four straps on all loads. Rig the load according to Figures 4-6 through 4-9.

4-27. Preparing and Installing Parachute

Prepare the G-14 cargo parachute as outlined in TM 10-1670-267-12&P/TO 13C7-1-101. Install the parachute on the load as shown in Figure 3-4.

4-28. Installing Altitude Sensor Parachute Staging Unit and Pilot Parachute

Install the altitude sensor parachute staging unit and a 30-inch pilot parachute as shown in Figure 4-13. This procedure must be completed by a parachute rigger.

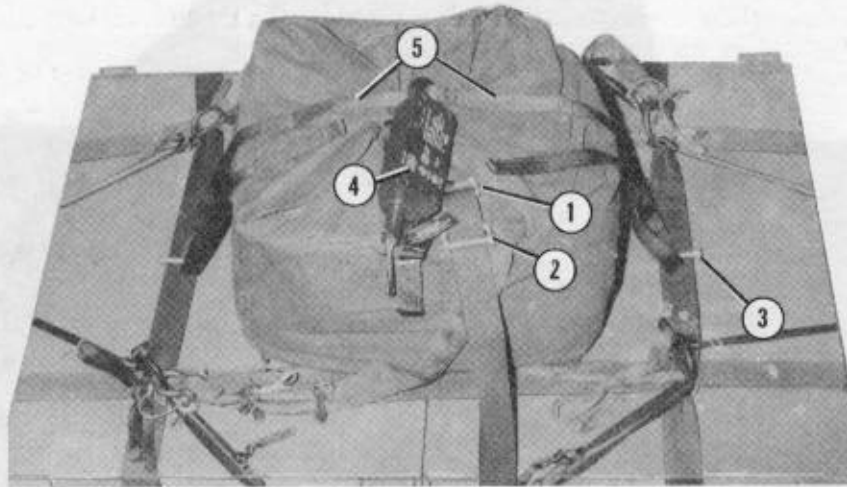

- ① Attach the 60-inch connector strap (attached to the pilot parachute) to the 53-inch HAARS deployment line with an L-bar connector link.
- ② Attach a second L-bar connector link to the loop of the 60-inch connector strap.
- ③ Attach an L-bar connector link to the A-7A strap on each side of the parachute.
- ④ Place the altitude sensor parachute staging unit on top of the parachute.
- ⑤ Pass one end of a 70-inch shear strap through the L-bar connector link attached to one of the A-7A straps. Pass the same end of the shear strap to the top of the parachute and through the cutter assembly portion of the altitude sensor parachute staging unit. Pass the same end of the strap through the other L-bar connector link. Pass the ends of the shear strap to the top of the load.

Figure 4-13. Altitude sensor parachute staging unit and 30-inch pilot parachute installed

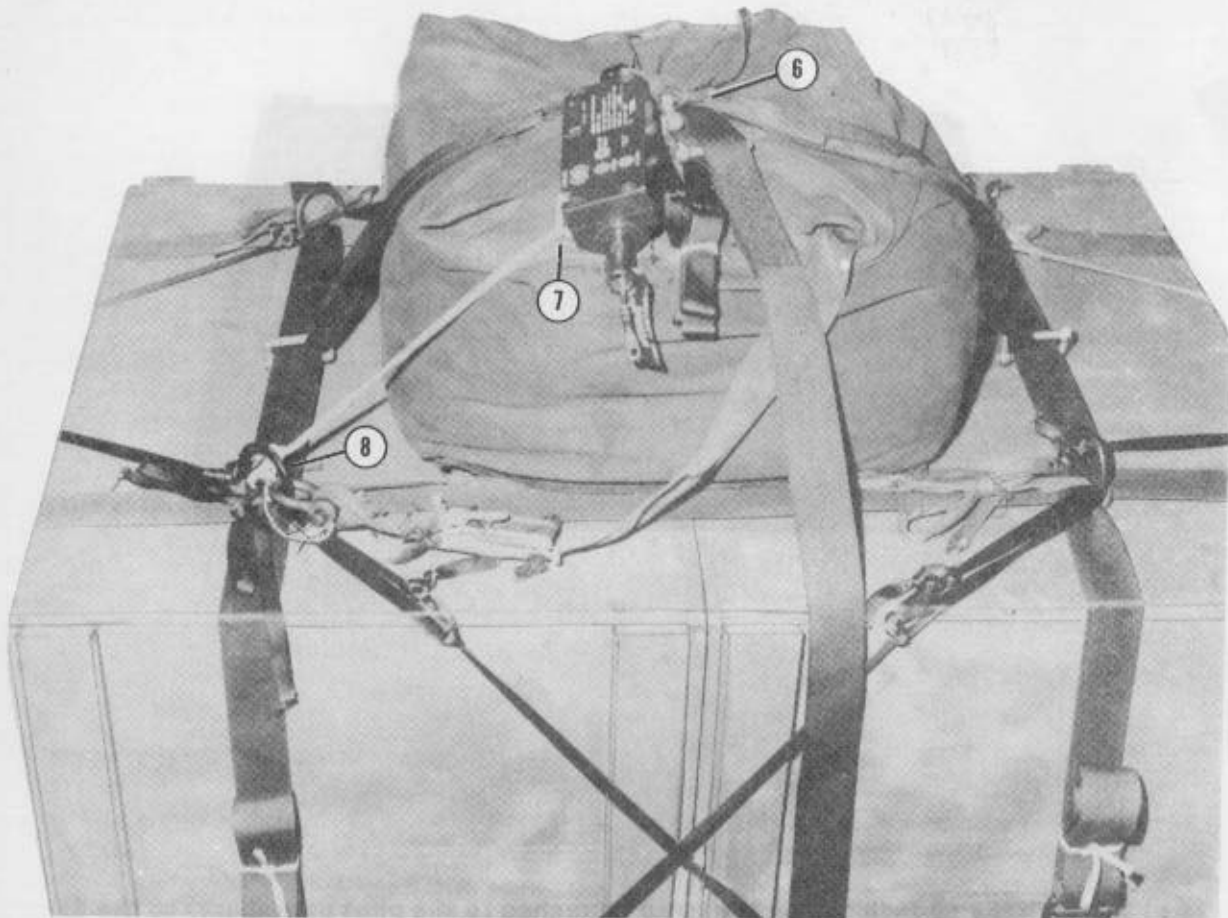

- ⑥ Attach both ends of the shear strap to the L-bar connector link installed in step 2.
- ⑦ Double a length of type III nylon cord. Pass the loop end of the cord through the hole in the left side of the altitude sensor parachute staging unit. Pass the free ends of the cord through the loop of the type III nylon cord.
- ⑧ Pull the free ends of the type III nylon cord tight. Tie the ends to the left front D-ring with a surgeon's knot and a locking knot.

Figure 4-13. Altitude sensor parachute staging unit and 30-inch pilot parachute installed (continued)

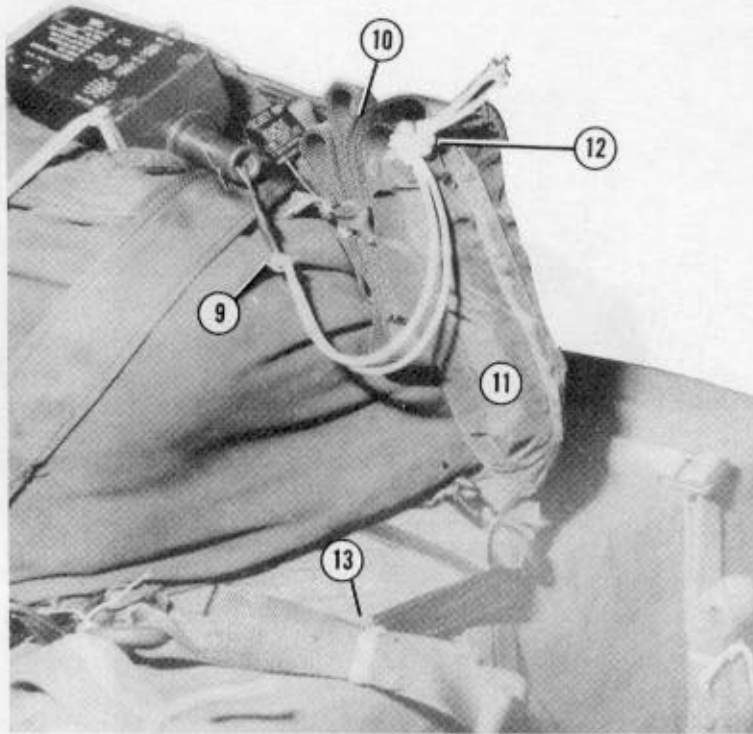

- ⑨ Double a length of type III nylon cord. Pass the loop end of the cord through the hole in the arming cable. Pass the free ends of the cord through the loop and pull them tight.
- ⑩ S-fold the 60-inch connector strap installed in step 1. Secure the folds with a retainer band.
- ⑪ Place the 30-inch pilot parachute toward the center of the load. Secure the parachute in place with ticket number 8/7 cotton thread.
- ⑫ Tie the type III nylon cord attached to the altitude sensor parachute staging unit arming cable to the L-bar connector link on the bottom of the 30-inch pilot parachute using a square knot and a locking knot in the free end.
- ⑬ S-fold the static line of the 30-inch pilot parachute, and secure the folds with a retainer band.

Figure 4-13. Altitude sensor parachute staging unit and 30-inch pilot parachute installed (continued)

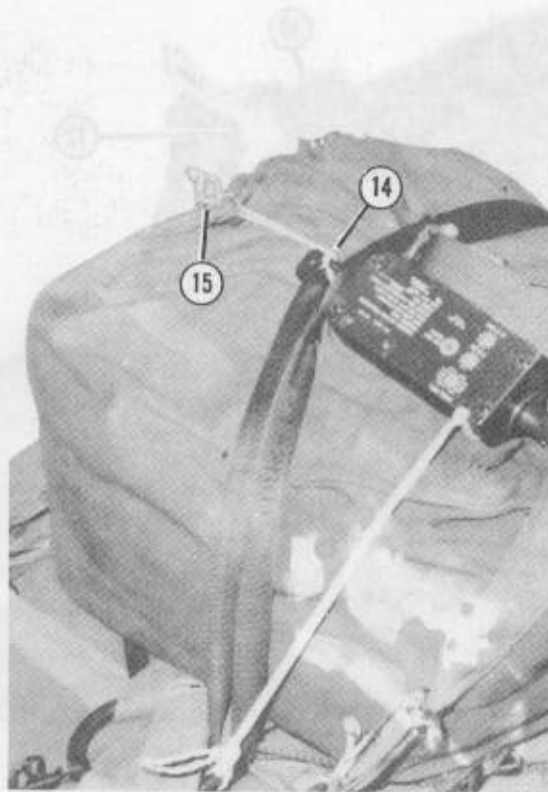

- ③ Double a length of type I nylon cord. Pass the top end of the cord through the hole in the sewing cable. Pass the two ends of the cord through the loop and pull them tight.
- ④ Fold the 40-inch connector strap installed in step 1. Secure the folds with a retaining band.
- ⑤ Place the 30-inch pilot parachute toward the center of the load. Secure the parachute in place with ratchet number 617 cotton thread.
- ⑭ Pass one end of a length of type I, 1/4-inch cotton webbing through the cutter assembly portion of the altitude sensor parachute staging unit and around both plies of the 70-inch shear strap. Pull the ends of the webbing tight, and tie the webbing to the cutter assembly with a surgeon's knot and a locking knot.
- ⑮ Secure the ends of the webbing to the deployment bag static line stow bar loop.

Figure 4-13. Altitude sensor parachute staging unit and 30-inch pilot parachute installed (continued)

4-29. Marking Rigged Load

Mark the rigged load according to Chapter 1. Compute the rigged load data.

4-30. Equipment Required

Use the equipment listed in Table 4-4 to rig the load as shown in Figure 4-14.

CAUTION
 Make the final inspection required by Chapter 1 before the load leaves the rigging site. If the load includes hazardous material as defined in AFJMAN 24-204/TM 38-250, complete Shipper's Declaration for Dangerous Goods form.

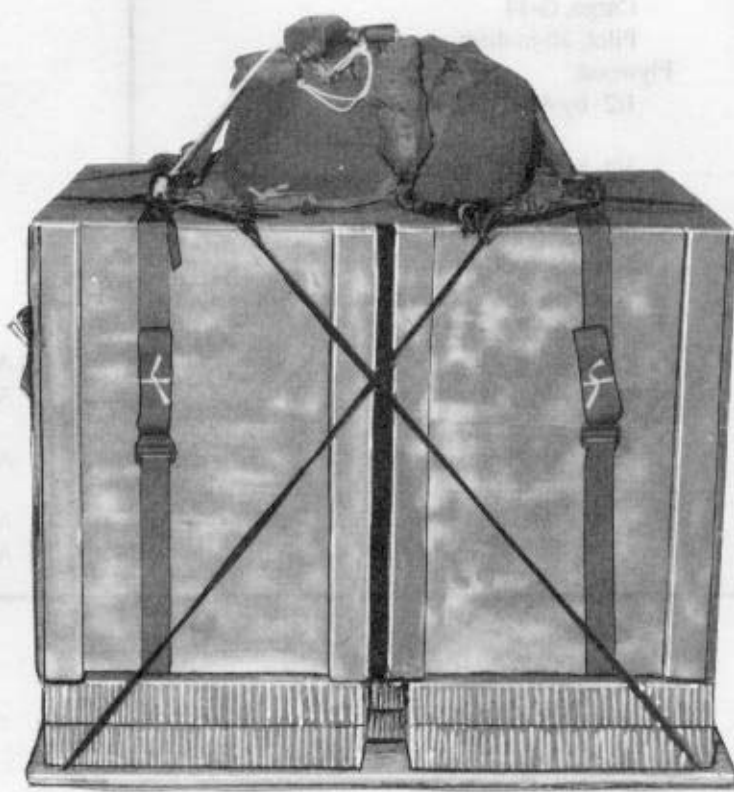

RIGGED LOAD DATA	
Weight (without parachute)	200 - 500 pounds
Parachute	G-14

Figure 4-14. A-7A container load rigged for HAARS

Table 4-4. Equipment required for rigging an A-7A container load for HAARS

National Stock Number	Item	Quantity
1670-01-071-5022	Altitude sensor, parachute unit;	1
1377-01-064-4927	Cutter assembly	(1)
1670-01-064-4926	Sensor w retention line	(1)
1670-01-121-0954	Bag, deployment w static line (HAARS)	
	(for 30-inch parachute)	1
4020-00-240-2146	Cord, nylon, type III, 550-lb	As required
1670-01-121-0766	Line, deployment (HAARS), 53-in	1
1670-00-217-2421	Link assembly, L-bar type	5
1670-00-753-3928	Pad, energy-dissipating, honeycomb	As required
	Parachute:	
1670-00-999-2658	Cargo, G-14	1
1670-01-121-5819	Pilot, 30-in diam	1
	Plywood:	
5530-00-129-7777	1/2- by 48- by 96-in	1 sheet
	<u>or</u>	
5530-00-128-4981	3/4- by 48- by 96-in	1 sheet
1670-00-251-1153	Sling assembly, cargo, airdrop, A-7A	1
	Strap:	
1670-00-738-5878	Connector, 60-in	2
1670-01-121-0767	Webbing, nylon (shear strap), 70-in	
	(HAARS)	1
7510-00-266-6710	Tape, masking, 2-in	As required
8310-01-102-4478	Thread, cotton, ticket number 8/7	As required
	Webbing:	
8305-00-268-2411	Cotton, 1/4-in, type I	As required
	Nylon, tubular:	
8305-00-082-5752	1/2-in	As required
8305-00-268-2455	1-in	As required

PART THREE RIGGING A-21 CONTAINER LOADS

CHAPTER 5 GENERAL INFORMATION AND PROCEDURES

5-1. A-21 Cargo Bag Assembly

The A-21 cargo bag assembly is an adjustable airdrop container. It consists of a sling assembly and a 97- by 115-inch canvas cover. The sling assembly consists of the sling portion with a scuff pad attached, two O-ring

straps, three quick-release straps, and one quick-release strap with a quick-release assembly attached. Figure 5-1 shows an A-21 cargo bag assembly.

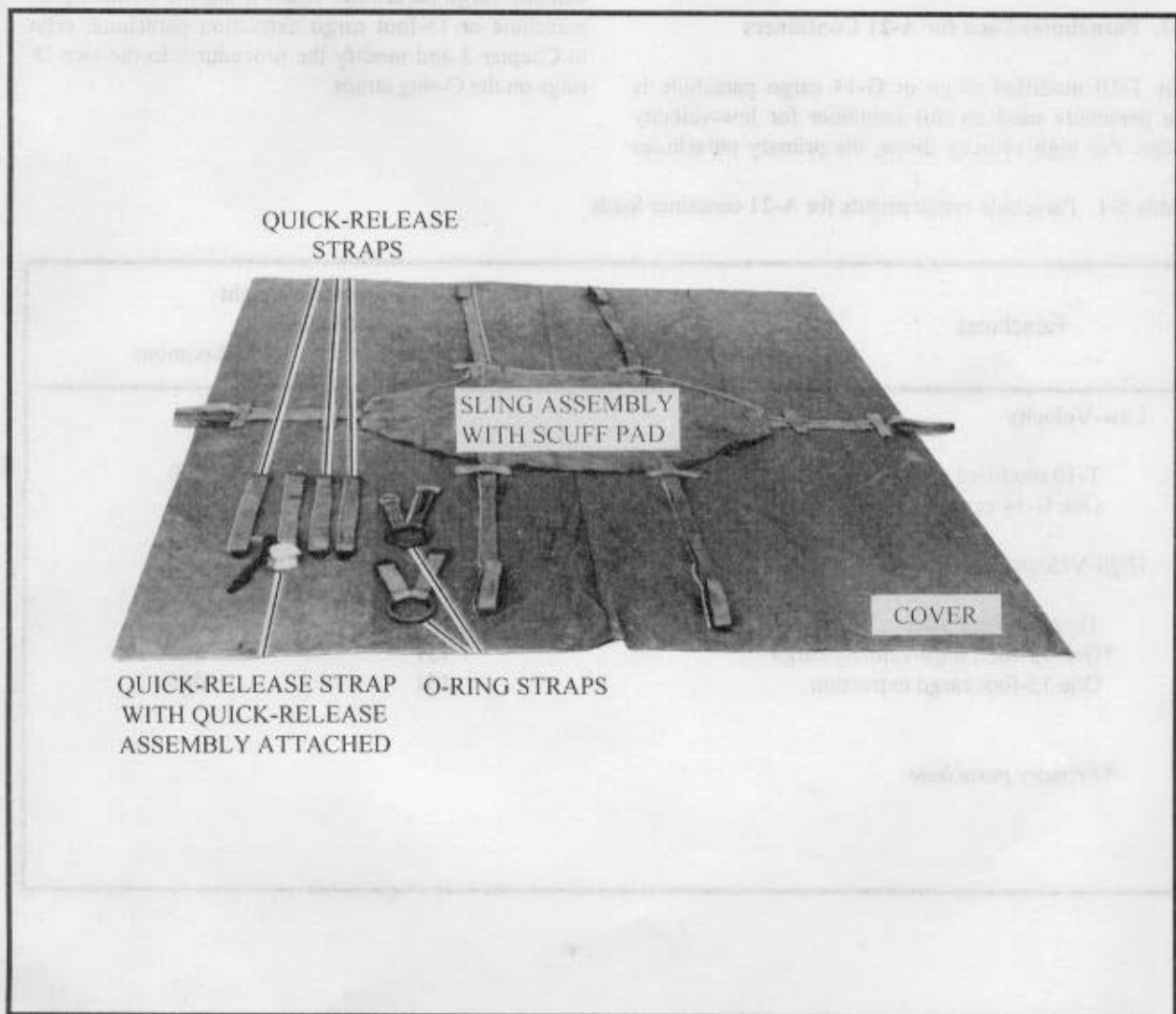

Figure 5-1. A-21 cargo bag assembly

5-2. Capabilities of A-21 Bag

The A-21 container can be dropped from Army and Air Force aircraft. It can exit either through paratroop doors or off the ramp. The container can be rigged for low velocity, high velocity, or HAARS. The container is capable of dropping loads up to 500 pounds of rigged weight, excluding the weight of the parachute. When dropped from the paratroop doors, the load must weigh a minimum of 11 pounds per square foot. When dropped from the ramp, the load must weigh a minimum of 28 pounds per square foot. Table 5-1 lists parachutes used with this container and the weight restriction.

5-3. Parachutes Used for A-21 Containers

The T-10 modified cargo or G-14 cargo parachute is the parachute used on this container for low-velocity drops. For high-velocity drops, the primary parachutes

are three 68-inch pilot parachutes or one 12-foot, high-velocity cargo parachute. If a 12-foot, high-velocity cargo parachute is not available, a 15-foot, cargo extraction parachute may be used. Table 5-1 gives the weight ranges.

5-4. Installation of Parachutes on A-21 Containers

All parachutes used on A-21 loads are installed to the two D-rings located on the O-ring straps. Figure 5-2 shows how to install the G-14 cargo parachute. Steps similar to the G-14 cargo parachute installation are used when installing the T-10 modified cargo parachute. Figure 5-3 shows how to install the 12-foot, high-velocity cargo parachute. When using the 68-inch pilot parachute or 15-foot cargo extraction parachute, refer to Chapter 3 and modify the procedures to the two D-rings on the O-ring straps.

Table 5-1. Parachute requirements for A-21 container loads

Parachutes	Suspended Weight (Pounds)	
	Minimum	Maximum
Low-Velocity		
T-10 modified cargo	90	500
One G-14 cargo	200	500
High-Velocity		
Three 68-inch pilot	151	500
*One 12-foot, high-velocity cargo	151	500
One 15-foot cargo extraction	151	500
*Primary parachute		

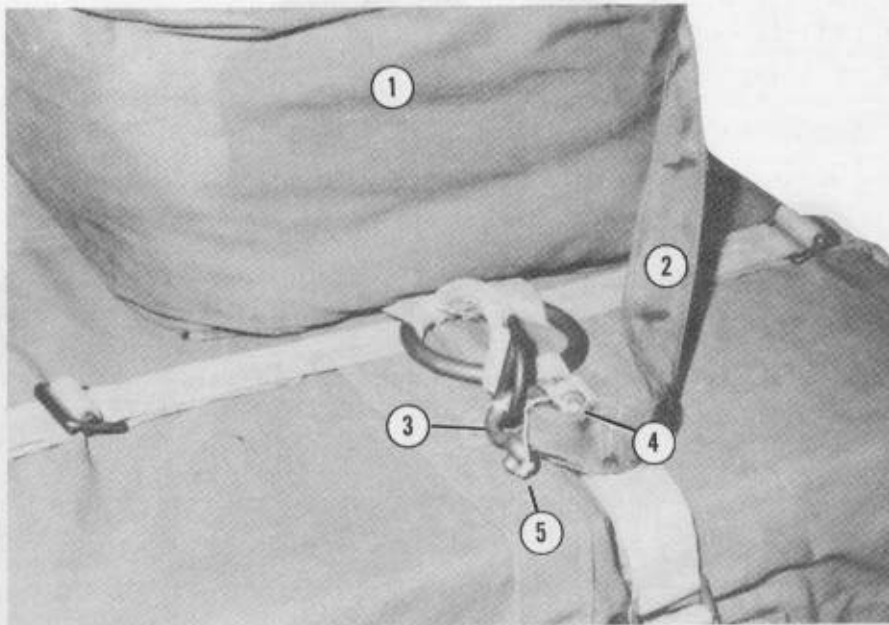

- ① Center the parachute on the load between the O-rings.
- ② Pull each riser to the closer D-ring on the end of the O-ring straps.
- ③ Place the bell portion of the clevis on the D-ring.
- ④ Route the clevis pin through one side of the clevis, through the loop at the end of the riser, and through the other hole on the other side of the clevis.
- ⑤ Insert the cotter pin through the clevis pin and spread the ends of the cotter pin enough to prevent the cotter pin from sliding out.

Figure 5-2. G-14 cargo parachute installed



- ⑥ Repeat steps 3 through 5 with the other clevis.
- ⑦ Tie the parachute tie tapes to convenient points on the load.

Figure 5-2. G-14 cargo parachute installed (continued)

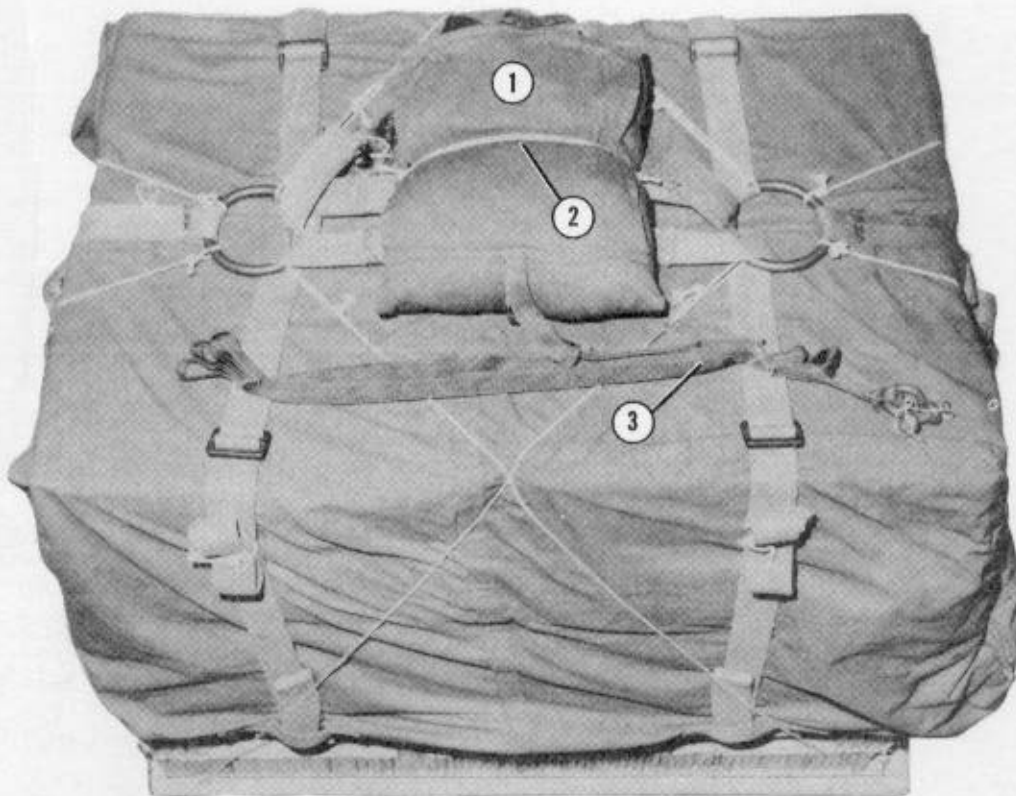

- ① Install the parachute to the load using steps 1 through 6 of Figure 5-2.
- ② Secure the parachute to the load using a length of type I, 1/4-inch cotton webbing. Tie one end to a convenient point on one side of the parachute. Pass the other end over the parachute and tie it to a convenient point on the other side of the parachute.
- ③ S-fold the static line on top of the load. Secure the folds to the top of the load with lengths of ticket number 8/7 cotton thread.

Figure 5-3. The 12-foot, high-velocity cargo parachute installed

CHAPTER 6 RIGGING TYPICAL A-21 LOADS

Section I

LOW-VELOCITY AIRDROP FROM PARATROOP DOOR

6-1. Description of Load

Typical A-21 loads are rigged for airdrop from a paratroop door of an aircraft. Typical loads include rations, repair parts, water cans, and other small nonfragile items. Items to be dropped may be rigged in their original container or may be repacked and padded further to prevent damage. When completely rigged, the load must not exceed 500 pounds, excluding the weight of the parachute. The maximum dimensions for this load are 48 by 30 by 66 inches. Refer to Part Two for general rigging information and aircraft considerations and restrictions.

6-2. Preparing Drop Items

Prepare the drop items according to the load's sensitivity. Some items will require no padding while other will need padding with cellulose wadding, felt, and honeycomb. All items should be padded well to prevent damage during airdrop. In addition, items must be in containers large enough so they will not fall out of the load during airdrop.

6-3. Positioning Container and Load

Position the container and load as shown in Figure 6-1.

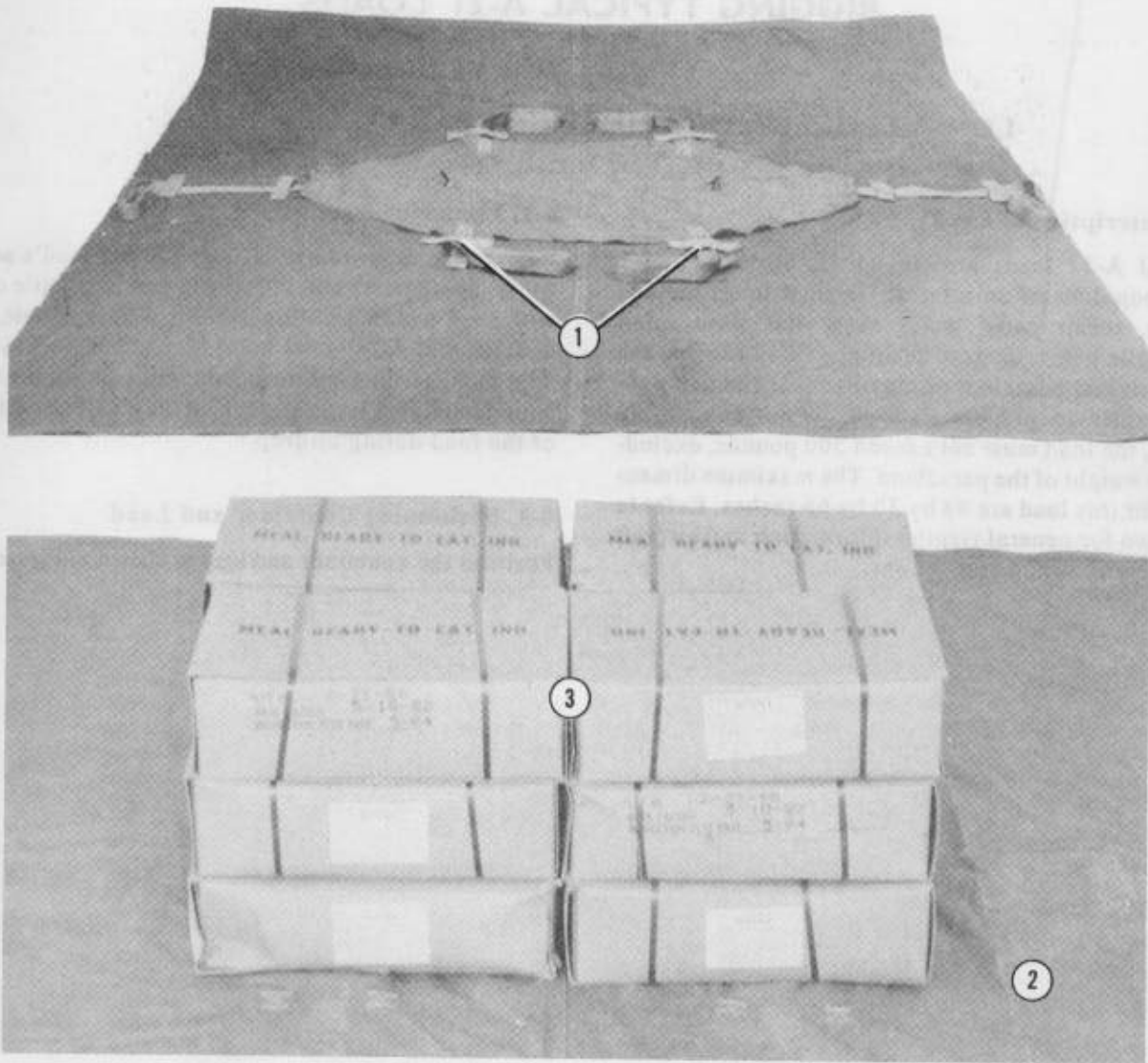

- ① Lay the A-21 bag cover on a flat, dry surface with the strap keepers up. Center the sling assembly on the cover with the sewn webbing facing the cover. Route the straps through the strap keepers.
- ② Flip the cover and sling assembly over. The scuff pad should be on the bottom.
- ③ Center the load on the cover and the sling assembly.

Note: One or two layers of honeycomb may be placed under the load, if needed.

Figure 6-1. Container and load positioned

6-4. Rigging Container

Rig the container as shown in Figure 6-2.

CAUTION

Make sure friction adapters are fastened properly according to Figure 1-3.

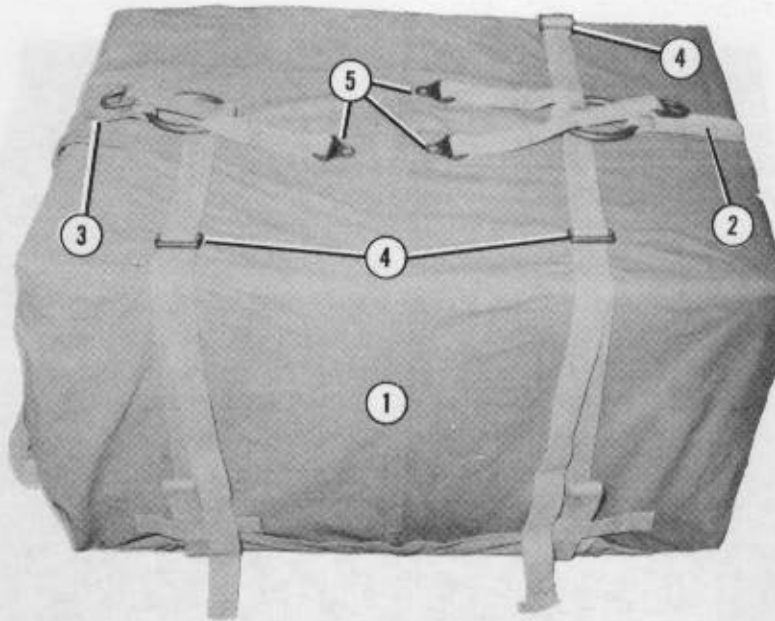

- ① Fold the cover over the load. Fold the excess cover under itself.
- ② Loosely fit an O-ring strap on the right side long strap.
- ③ Repeat step 2 for the left side long strap.
- ④ Fit a quick-release strap on the two front straps and the rear right strap.
- ⑤ Pass the free end of the quick-release strap under the O-ring and up through the center of the O-ring. Lay the running end toward the center of the load. Repeat step for the other two quick-release straps. There should be a half twist inward when the straps are routed properly.

Figure 6-2. Container rigged

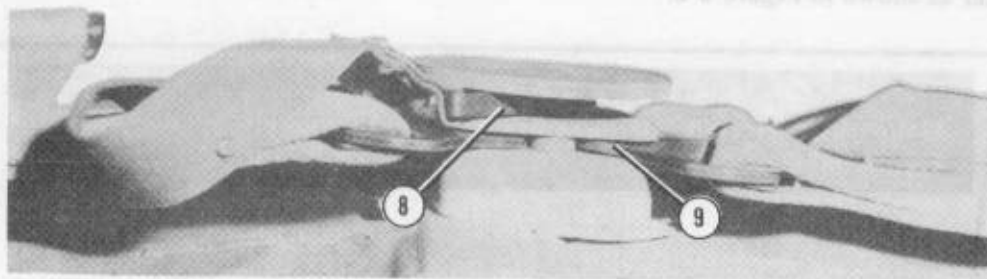

- ⑥ Center the strap with the quick-release assembly on the load. Route the strap over the left O-ring and down through the center. Fasten the friction adapter to the rear left strap. Make sure the friction adapter is fastened properly according to Figure 1-3.
- ⑦ Make sure the quick-release assembly plungers are up. Insert the three quick-release strap lugs into the quick release. Pull slightly on each to make sure the plungers lock the straps in place.
- ⑧ Insert the safety clip as shown in the insert.
- ⑨ Tighten all straps. Make sure the quick-release assembly is centered on the load. Fold the excess strap, and tie or tape it in place according to Figure 1-3.

Figure 6-2. Container rigged (continued)

6-5. Installing Parachute

Install the T-10 modified cargo or the G-14 cargo parachute according to Paragraph 5-4.

6-7. Equipment Required

Use the equipment listed in Table 6-1 to rig the load as shown in Figure 6-3.

6-6. Marking Rigged Load

Marked the rigged load according to Chapter 1. Compute the rigged load data.

CAUTION

Make the final inspection required by Chapter 1 before the load leaves the rigging site. If the load includes hazardous material as defined in AFJMAN 24-204/TM 38-250, complete Shipper's Declaration for Dangerous Goods form.



RIGGED LOAD DATA

Weight (without parachute)	200 - 500 pounds
Parachute	G-14

Figure 6-3. A-21 container load rigged for low-velocity paratroop door airdrop

Table 6-1. Equipment required for rigging the A-21 container load for low-velocity paratroop door airdrop

National Stock Number	Item	Quantity
1670-00-242-9173 8135-00-664-6958	Bag, cargo, A-21 Cushioning material, packaging, cellulose wadding	1 As required
1670-00-999-2658 8105-00-285-4744 8305-00-268-2411	Parachute, cargo, G-14 Sandbag Webbing, cotton, 1/4-in, type I	1 As required As required

Section II
LOW-VELOCITY AIRDROP FROM RAMP

6-8. Description of Load

Typical A-21 loads are rigged for drop off the ramp of an aircraft. Typical loads include rations, water cans, small parts, and other nonfragile supplies. The loads must be rigged with a skid board. The weight range for an A-21 load is 200 to 500 pounds, excluding the weight of the parachute.

6-9. Preparing Drop Items

Prepare the drop items according to the load's sensitivity. Some items will require no padding while others will require cellulose wadding, felt, and honeycomb. All items should be padded well to prevent damage during airdrop.

6-10. Preparing Skid Board

Prepare a skid board as shown in Figure 6-4.

6-11. Positioning Container and Load

Position the container and load according to paragraph 6-3.

6-12. Rigging Container

Rig the container according to paragraph 6-4.

6-13. Securing Skid Board

Secure the skid board to the load as shown in Figure 6-5.

- Notes: 1. This drawing is not drawn to scale.
2. All dimensions are given in inches.

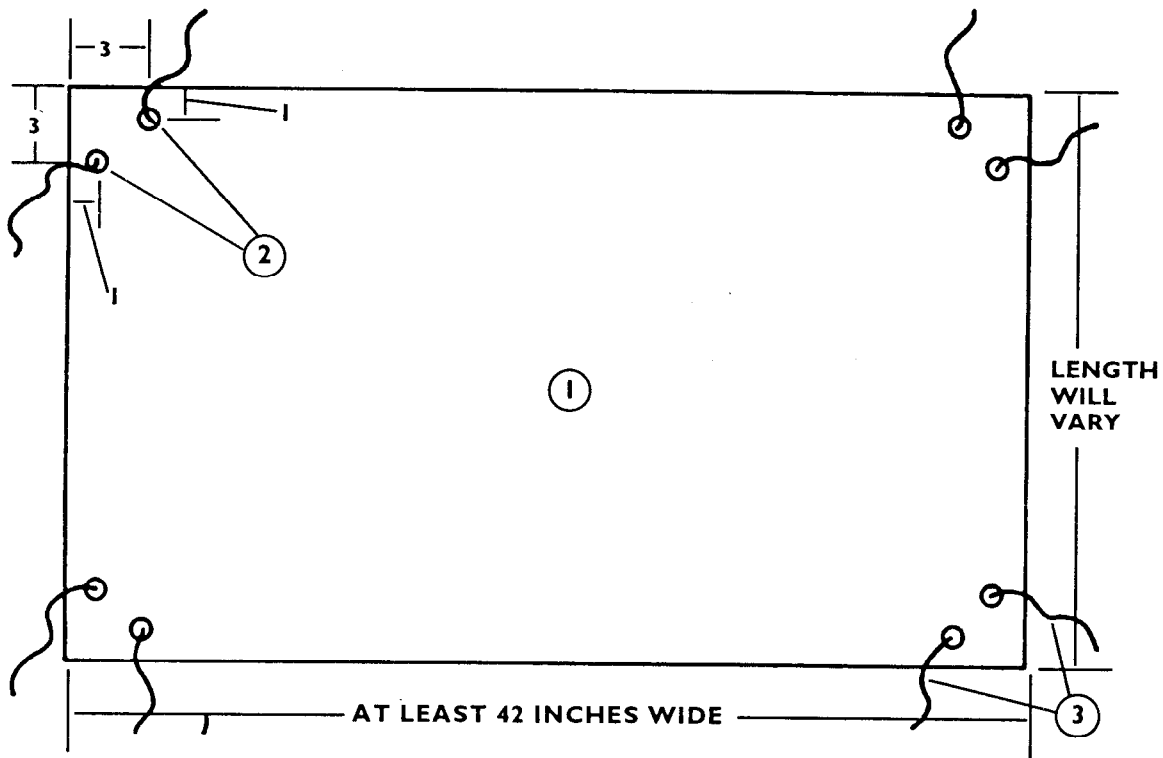

- ① Cut a 1/2- or 3/4-inch piece of plywood at least the size of the bottom of the load. If the load is to be dropped from Air Force aircraft, the plywood must be at least 42 inches wide. Place the plywood on a flat surface.
- ② Drill eight 1/2-inch holes as shown above.
- ③ Pass a length of type III nylon cord through each set of holes. The length should be long enough to allow the running ends to be tied to the top of the load. If type III nylon cord is not available, use 1/2-inch tubular nylon webbing.
- ④ If needed, place two layers of honeycomb (not shown) the size of the base of the load on the skid board.

Figure 6-4. Skid board prepared

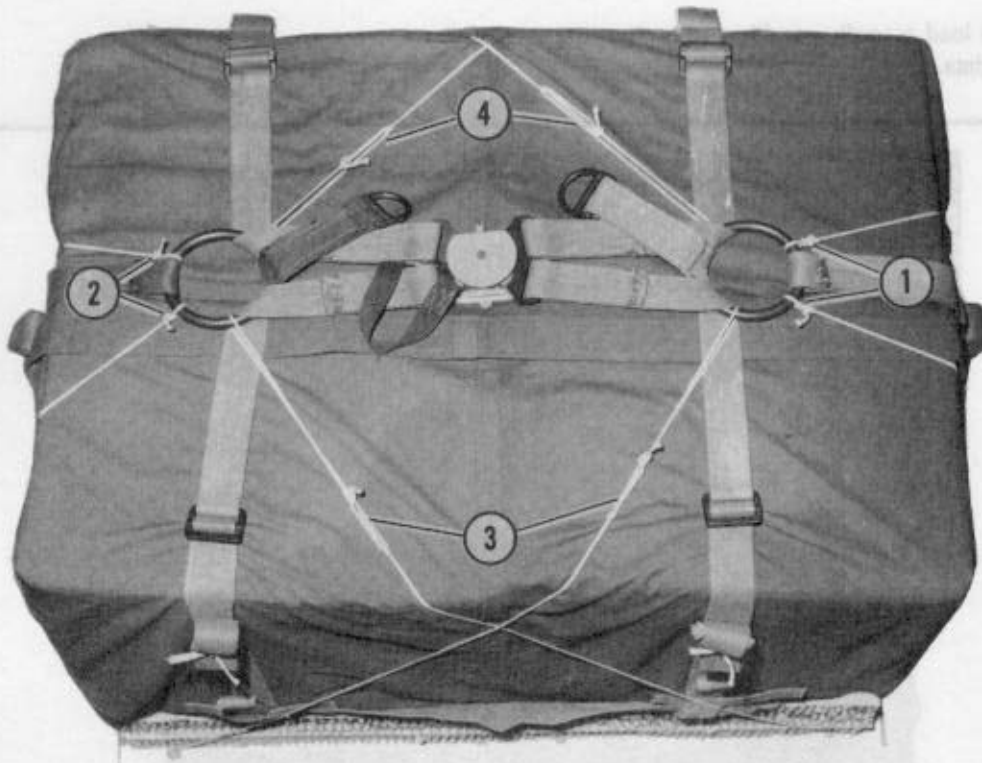

- ① Tie the two lengths of type III nylon cord on the right side of the load to the top right O-ring with three half-hitch knots and a knot in the running end. These ties will not cross each other.
- ② Repeat step 1 using the lengths on the left side.
- ③ Using the front right length of cord, cross it over the load and tie it to the left O-ring with a trucker's hitch knot and an overhand knot in the running end. Repeat with the left front length of cord to the right O-ring. Ties should form an "X."
- ④ Repeat step 3 using the lengths on the rear.

Figure 6-5. Skid board secured

6-14. Installing Parachute

Install the T-10 modified cargo or the G-14 cargo parachute to the load according to Paragraph 5-4.

6-16. Equipment Required

Use the equipment listed in Table 6-2 to rig the load shown in Figure 6-6.

6-15. Marking Rigged Load

Mark the rigged load according to Chapter 1. Compute the rigged load data.

CAUTION

Make the final inspection required by Chapter 1 before the load leaves the rigging site. If the load includes hazardous material as defined in AFJMAN 24-204/TM 38-250, complete Shipper's Declaration for Dangerous Goods form.



RIGGED LOAD DATA

Weight (without parachute)	200 - 500 pounds
Parachute	G-14

Figure 6-6. A-21 container load rigged for low-velocity ramp airdrop

Table 6-2. Equipment required for rigging the A-21 container load for low-velocity ramp airdrop

National Stock Number	Item	Quantity
1670-00-242-9173	Bag, cargo, A-21	1
4020-00-240-2146	Cord, nylon, type III, 550-pound	As required
8135-00-664-6958	Cushioning material, packaging, cellulose wadding	As required
1670-00-753-3928	Pad, energy-dissipating, honeycomb	As required
1670-00-999-2658	Parachute, cargo, G-14	1
	Plywood:	
5530-00-129-7777	1/2- by 48- by 96-in	1 sheet
	<u>or</u>	
5530-00-128-4981	3/4- by 48- by 96-in	1 sheet
8105-00-285-4744	Sandbag	As required
8305-00-268-2411	Webbing, cotton, 1/4-in, type I	As required

Section III HIGH-VELOCITY AIRDROP

6-17. Description of Load

Typical A-21 loads are rigged for high-velocity airdrop from either the paratroop door or ramp of an aircraft. Typical loads include rations, water cans, small repair parts, and other small nonfragile items. The load shown in this section consists of rations and boxes filled with sand to increase weight. The load cannot exceed 500 pounds, excluding the weight of the parachute. The minimum weight will vary according to the parachute used. The load shown in this section is rigged with one 12-foot, high-velocity cargo parachute.

6-18. Preparing Drop Items

Prepare the drop items according to the load's sensitivity. Items should be well padded so items will not be damaged during airdrop. Items can be dropped in original container or repacked if necessary.

6-19. Preparing Skid Board

Prepare a skid board for ramp drop as shown in Figure 6-4. For paratroop door drops, the skid board is optional. When the load is dropped from the ramp on Air Force aircraft, the skid board must be 42 inches wide.

6-20. Positioning Honeycomb

Use honeycomb on paratroop door or ramp drops. When the skid board is not used, place the honeycomb inside the container when rigging the load. When the skid board is used, place honeycomb inside or outside the container. Prepare and position the honeycomb as shown in Figure 6-7.

Note: Glue the stack together.

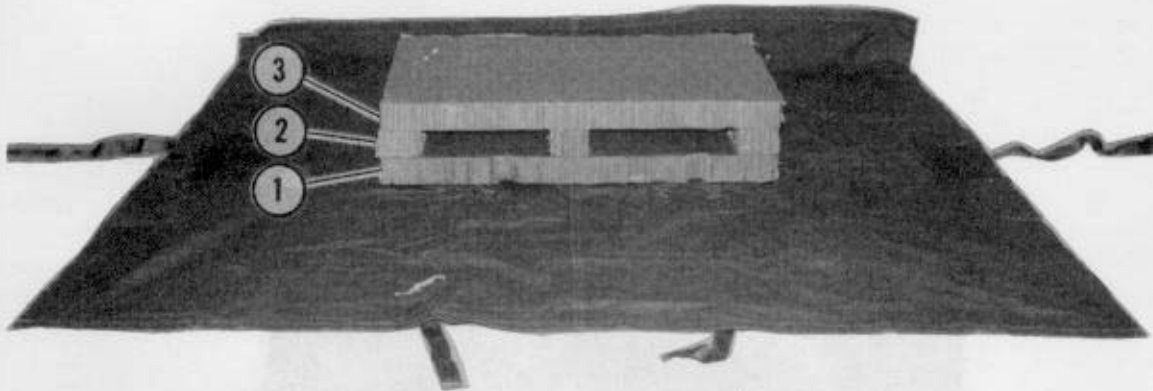

- 1 Cut one piece of honeycomb at least the size of the base of the load. Center it on the container. Glue it to the container if desired.
- 2 Cut three pieces of honeycomb 3 inches wide and the length of the honeycomb cut in step 1. Center one piece on top of the first layer of honeycomb. Place one piece of honeycomb even with each side edge.
- 3 Cut another piece of honeycomb the same size as in step 1, and place it on top of the second layer of honeycomb.

Figure 6-7. Honeycomb prepared and positioned

6-21. Positioning Container and Load

Position the container and load according to paragraph 6-3.

6-22. Rigging Container

Rig the container according to paragraph 6-4.

6-23. Securing Skid Board

Secure the skid board according to paragraph 6-13.

6-24. Installing Parachute

Install the parachute according to Chapters 3 and 5.

6-25. Marking Rigged Load

Mark the rigged load according to Chapter 1. Compute the rigged load data.

6-26. Equipment Required

Use the equipment listed in Table 6-3 to rig the load shown in Figure 6-8.

CAUTION

Make the final inspection required by Chapter 1 before the load leaves the rigging site. If the load includes hazardous material as defined in AFJMAN 24-204/TM 38-250, complete Shipper's Declaration for Dangerous Goods form.



RIGGED LOAD DATA

Parachute	Weight (without parachute)
Three 68-inch	151 - 500 pounds
* 12-foot, high-velocity cargo (shown)	151 - 500 pounds
15-foot (modified for high-velocity)	151 - 500 pounds
* Primary parachute	

Figure 6-8. A-21 container load rigged for high-velocity airdrop

Table 6-3. Equipment required for rigging the A-21 container load for high-velocity airdrop

National Stock Number	Item	Quantity
8040-00-273-8713	Adhesive, paste, 1-gal	As required
1670-00-242-9173	Bag, cargo, A-21	1
4020-00-240-2146	Cord, nylon, type III, 550-lb	As required
8135-00-664-6958	Cushioning material, packaging, cellulose wadding	As required
1670-00-753-3928	Pad, energy-dissipating, honeycomb	As required
1670-00-788-8666	Parachute, cargo, high-velocity, 12-ft	1
5530-00-129-7777	Plywood: 1/2- by 48- by 96-in	1 sheet
5530-00-128-4981	<u>or</u> 3/4- by 48- by 96-in	1 sheet
7510-00-266-6710	Tape, masking, 2-in	As required
8305-00-268-2411	Webbing: Cotton, 1/4-in, type I	As required
8305-00-082-5752	Nylon, tubular, 1/2-in	As required

Section IV

HAARS

6-27. Description of Load

The A-21 typical container load rigged for delivery by HAARS requires a 30-inch pilot parachute, an altitude sensor parachute staging unit, a 70-inch shear strap, and a G-14 cargo parachute equipped with a 53-inch HAARS deployment line. Typical loads include rations, water cans, small repair parts, and other small nonfragile items. The A-21 load may be dropped from the paratroop door or off the ramp of an aircraft.

6-28. Rigging Container

Rig the container as a typical A-21 low-velocity load with skid board attached. Paragraphs 6-10 through 6-13 cover rigging the container.

6-29. Preparing and Installing Cargo Parachute

Prepare the G-14 cargo parachute according to TM 10-1670-266-13&P. Install the parachute according to Chapter 5.

6-30. Installing Altitude Sensor Parachute Staging Unit and Pilot Parachute

Install the altitude sensor parachute staging unit and 30-inch pilot parachute by adapting the procedures given in Figure 4-13.

6-31. Marking Rigged Load

Mark the rigged load according to Chapter 1 using the data given in Figure 6-9. If the load varies from the one shown in Figure 6-9, recompute the rigged load data.

6-32. Equipment Required

Use the equipment listed in Table 6-4 to rig the load shown in Figure 6-9.

CAUTION

Make the final inspection required by Chapter 1 before the load leaves the rigging site. If the load includes hazardous material as defined in AFJMAN 24-204/TM 38-250, complete Shipper's Declaration for Dangerous Goods form.

**RIGGED LOAD DATA**

Weight (without parachute)	200 - 500 pounds
Height (with parachute)	41 inches
Width	27 inches
Length	42 inches
Parachute	G-14

Figure 6-9. A-21 container load rigged for HAARS

Table 6-4. Equipment required for rigging an A-21 container load for HAARS

National Stock Number	Item	Quantity
1670-01-071-5022	Altitude sensor, parachute unit:	1
1377-01-064-4927	Cutter assembly	(1)
1670-01-064-4926	Sensor w retention line	(1)
	Bag:	
1670-00-242-9173	Cargo, A-21	1
1670-01-121-0954	Deployment w static line (HAARS) (for 30-inch parachute)	1
4020-00-240-2146	Cord, nylon, type III, 550-lb	As required
1670-01-121-0766	Line, deployment (HAARS)	1
1670-00-217-2421	Link assembly, link, L-bar type	5
1670-00-753-3928	Pad, energy-dissipating, honeycomb	As required
	Parachute:	
1670-00-999-2658	Cargo, G-14	1
1670-01-121-5819	Pilot, 30-in diam	1
5530-00-128-4981	Plywood, 3/4- by 48- by 96-in	1 sheet
	Strap:	
1670-00-738-5878	Connector, 60-in	2
1670-01-121-0767	Webbing, nylon (shear strap), 70-in (HAARS)	1
7510-00-266-6710	Tape, masking, 2-in	As required
8310-01-102-4478	Thread, cotton, ticket number 8/7	As required
	Webbing:	
8305-00-268-2411	Cotton, 1/4-in, type I	As required
	Nylon, tubular:	
8305-00-082-5752	1/2-in	As required
8305-00-268-2455	1-in	As required

CHAPTER 7 RIGGING SPECIFIC A-21 LOADS

Section I RIGGING GLLD FOR LOW-VELOCITY AIRDROP

7-1. Description of Load

The Ground Laser Location Designator (GLLD) is rigged in an A-21 cargo bag with one G-14 parachute. Three A-7A straps are also needed to secure equipment within the container to the skid board. The GLLD components are the tripod, night vision sight and battery, laser designator in a backpack, batteries, traversing unit and batteries, vehicle power conditioner, cables, and collimator. Four cases of rations are dropped with the GLLD.

7-2. Preparing Skid Boards

Prepare two skid boards as shown in Figure 7-1.

7-3. Placing Honeycomb and Top Skid Board

Place honeycomb and top skid board as shown in Figure 7-2.

7-4. Rigging GLLD

Rig the GLLD according to Figure 7-3.

7-5. Installing Parachute

Install the G-14 cargo parachute according to Chapter 5.

- Notes:**
1. This drawing is not drawn to scale.
 2. All dimensions are given in inches.
 3. The skid board is ramp-compatible, NOT CVRS-compatible.

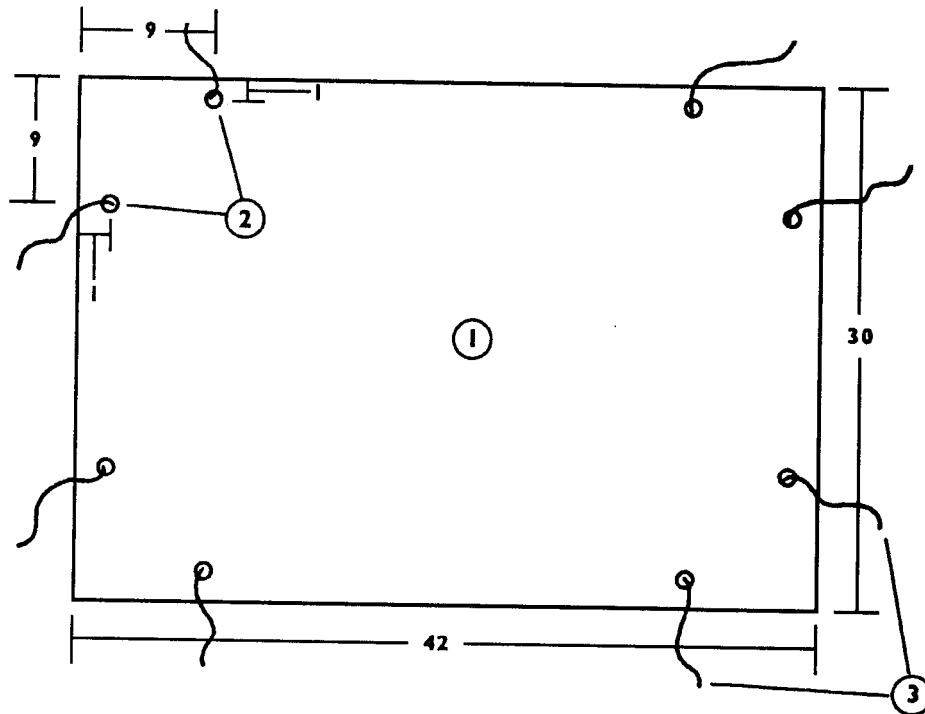

- 1 Cut two 3/4- by 30- by 42-inch pieces of plywood.
- 2 Drill eight 1/2-inch holes in each piece of plywood as shown above.
- 3 Place one piece of plywood on a flat surface. Cut four 13-foot lengths of 1/2-inch tubular nylon webbing. Pass a length of webbing through each set of holes in the plywood.

Figure 7-1. Skid boards prepared

Note: This drawing is not drawn to scale.

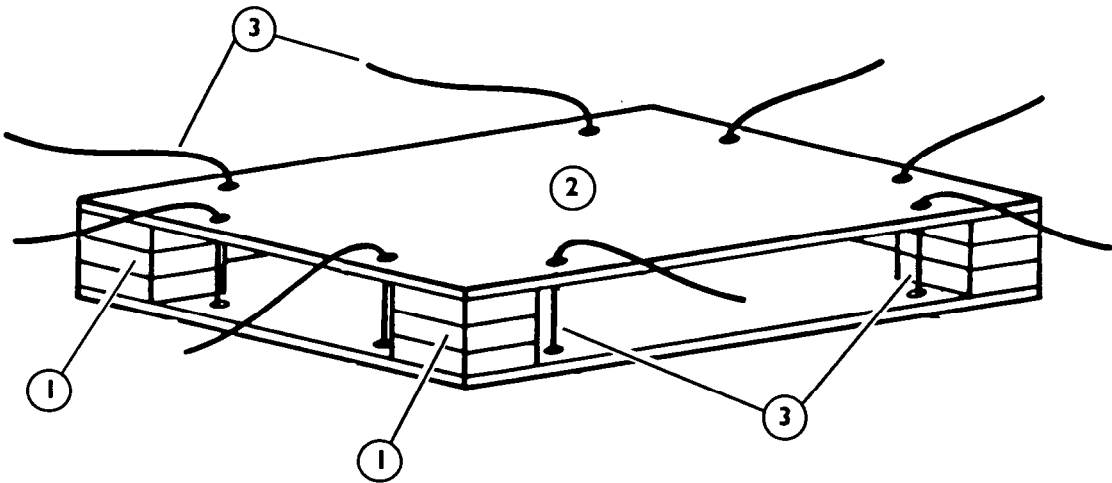

- ① Cut twelve 8- by 8-inch pieces of honeycomb. Place the honeycomb in four stacks (three pieces each). Glue each stack together. Place a stack flush in each corner of the skid board. Glue the stacks to the skid board.
- ② Center the top skid board (prepared in Figure 7-1) on top of the honeycomb.
- ③ Route the lengths of webbing (Figure 7-1, step 3) through the top skid board as shown above.

Figure 7-2. Honeycomb and top skid board placed

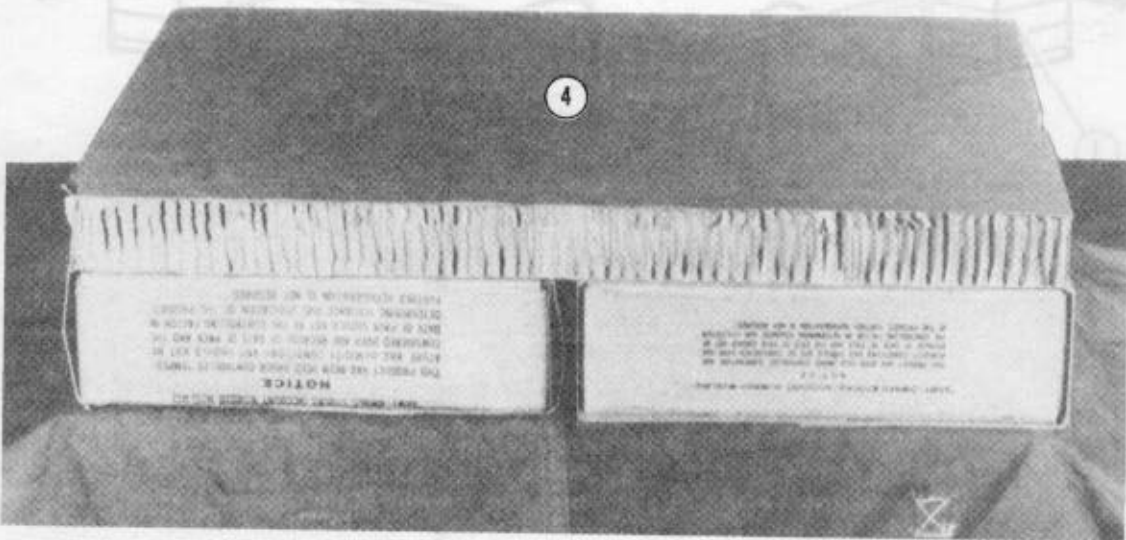
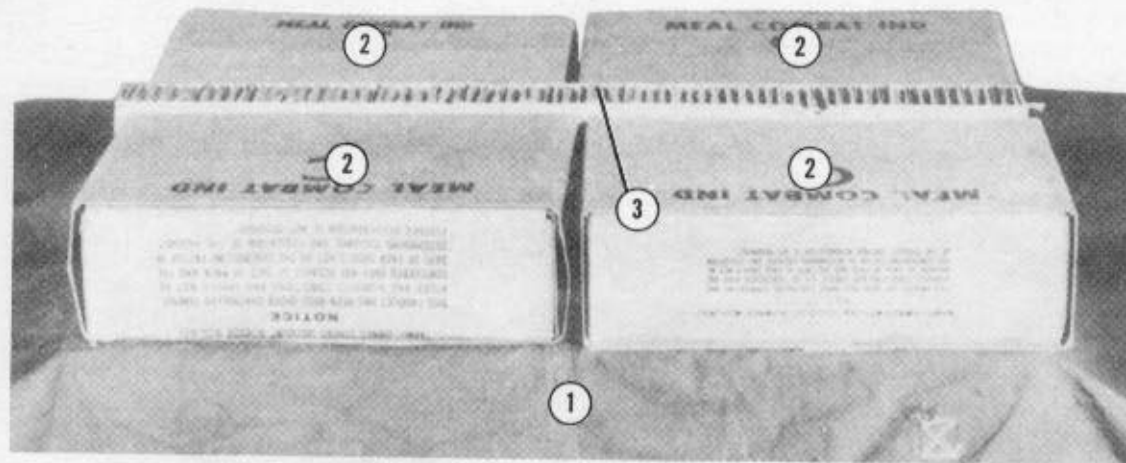

- ① Center the cover on the top skid board.
- ② Place four cases of rations on the A-21 cover.
- ③ Place scrap honeycomb between the rations.
- ④ Place a 30- by 42-inch piece of honeycomb on top of the rations.

Figure 7-3. GLLD rigged

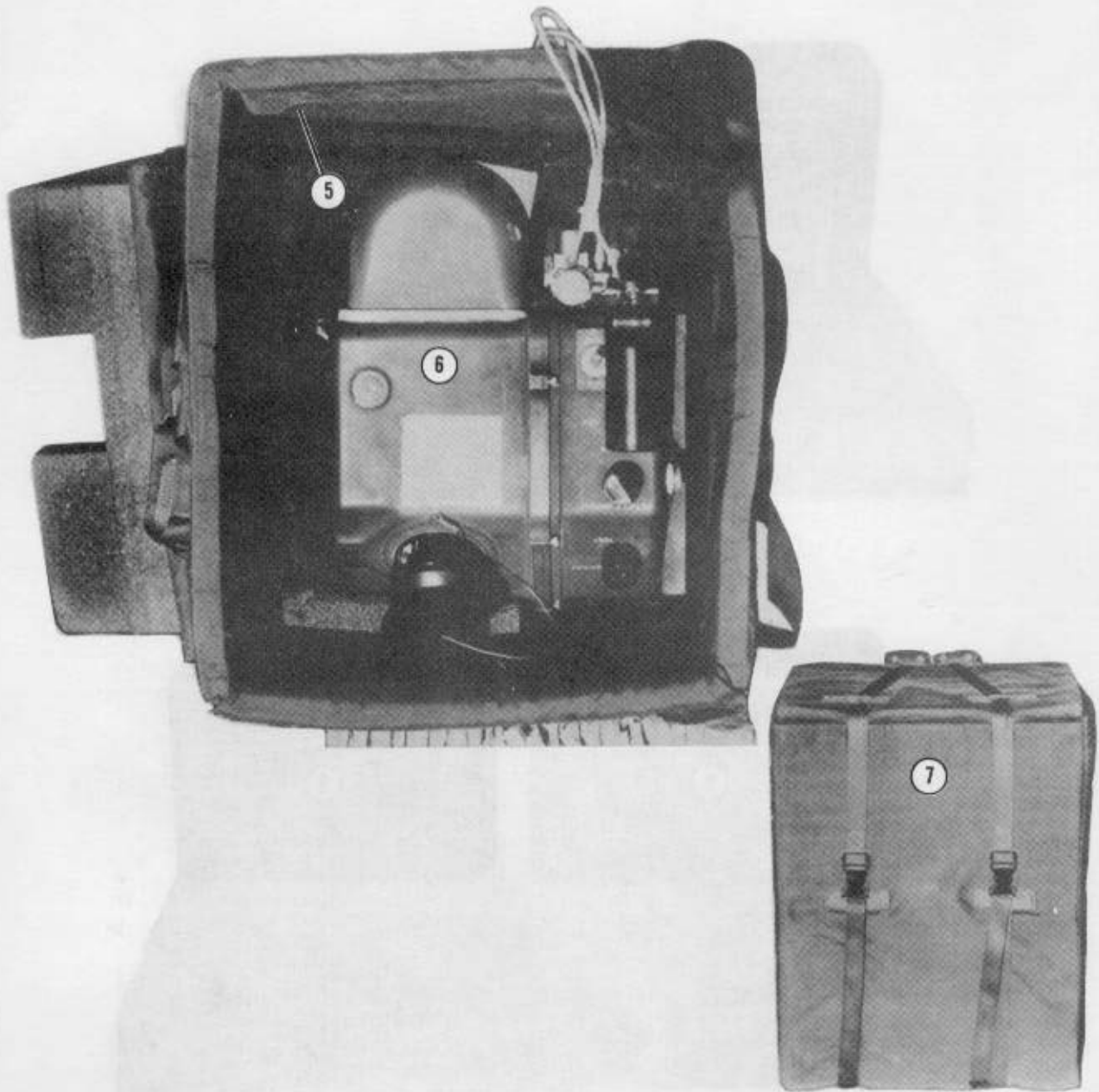

- ⑤ Remove the laser designator from the backpack. Cut pieces of felt to fit the bottom and each side of the backpack. Position them in place.
- ⑥ Replace the laser designator in the backpack.
- ⑦ Close the backpack, and secure the straps.

Figure 7-3. GLLD rigged (continued)



- ⑧ Place the collimator and the night sight at the rear of the 30- by 42-inch piece of honeycomb.
- ⑨ Pad the collimator and the night sight with felt.

Figure 7-3. GLLD rigged (continued)

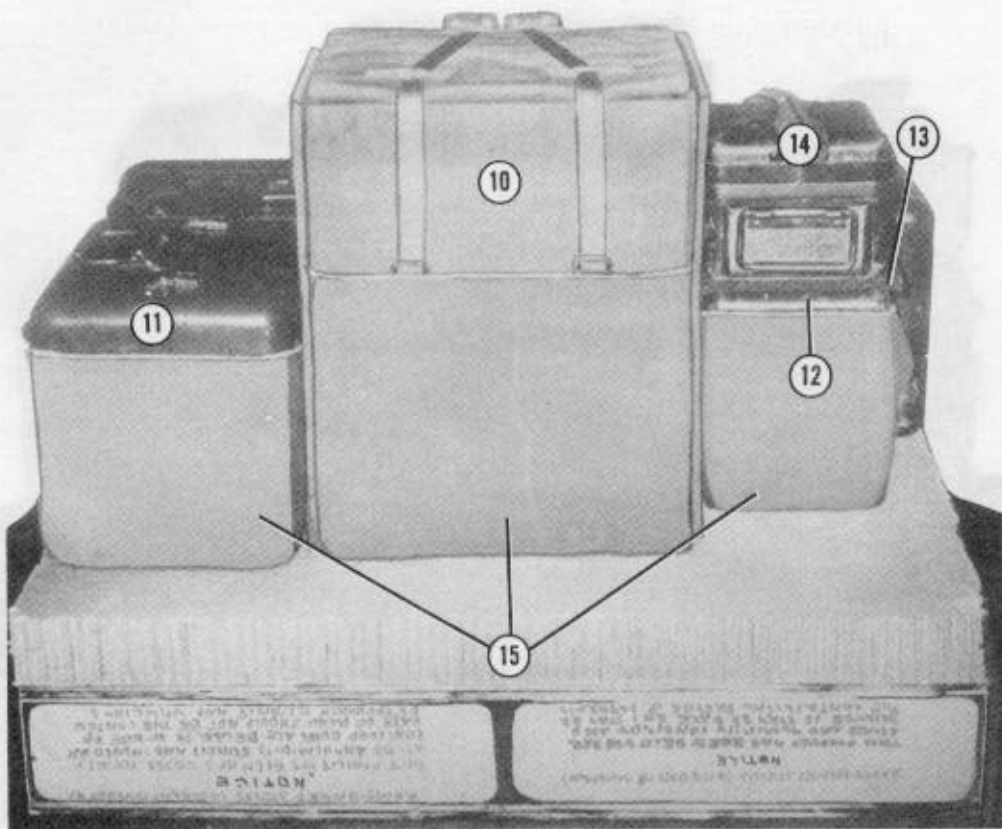

- ⑩ Place the laser designator near the center of the 30- by 42-inch piece of honeycomb.
- ⑪ Place the traversing unit on the honeycomb to the left of the laser designator.
- ⑫ Place the vehicle power conditioner on the honeycomb to the right of the laser designator.
- ⑬ Cut a piece of felt to fit the top of the power conditioner. Position it in place.
- ⑭ Place the night vision sight batteries on top of the power conditioner.
- ⑮ Pad the laser designator, the traversing unit, and the vehicle power conditioner with pieces of felt.

Figure 7-3. GLLD rigged (continued)

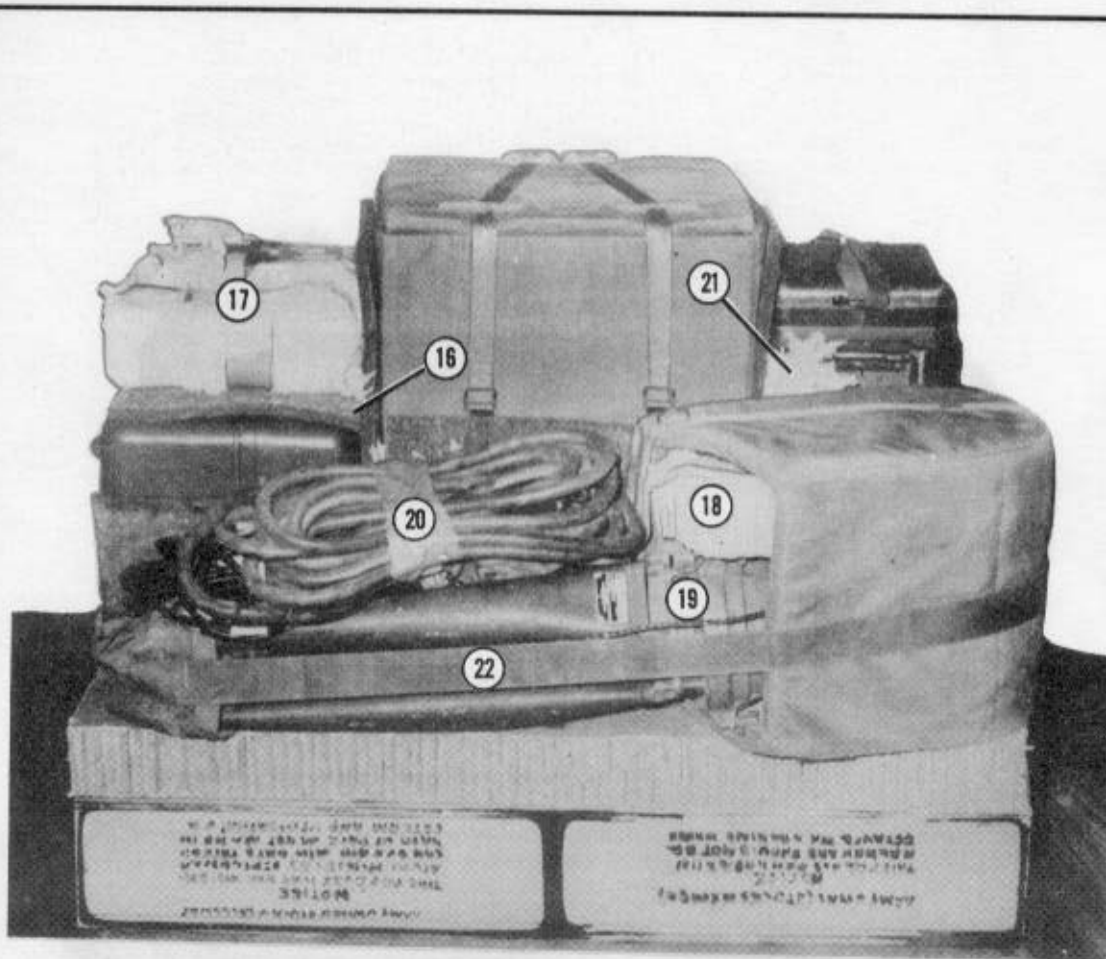

- ① Place the traversing unit on top of the load.
 - ② Place the battery pack on top of the traversing unit.
 - ③ Place the cable on top of the battery pack.
 - ④ Place the tripod on top of the cable.
 - ⑤ Place the honeycomb on top of the tripod.
 - ⑥ Place the wadding on top of the honeycomb.
 - ⑦ Place the A-7A airdrop cargo sling strap around the lower layer of equipment, and fasten the strap.
- ①6 Place a piece of felt on top of the traversing unit.
 - ①7 Wrap the traversing unit batteries in cellulose wadding. Tape the wadding in place. Place the wrapped batteries on top of the traversing unit.
 - ①8 Place a 6- by 6-inch piece of honeycomb on the tripod handle.
 - ①9 Place the tripod on the front of the 30- by 42-inch piece of honeycomb.
 - ②0 Roll up the cable, and tape it together. Place the cable on top of the tripod.
 - ②1 Wrap extra batteries and small parts in cellulose wadding, and tape the wadding in place. Place these items on the load.
 - ②2 Pass an A-7A airdrop cargo sling strap around the lower layer of equipment, and fasten the strap.

Figure 7-3. GLLD rigged (continued)

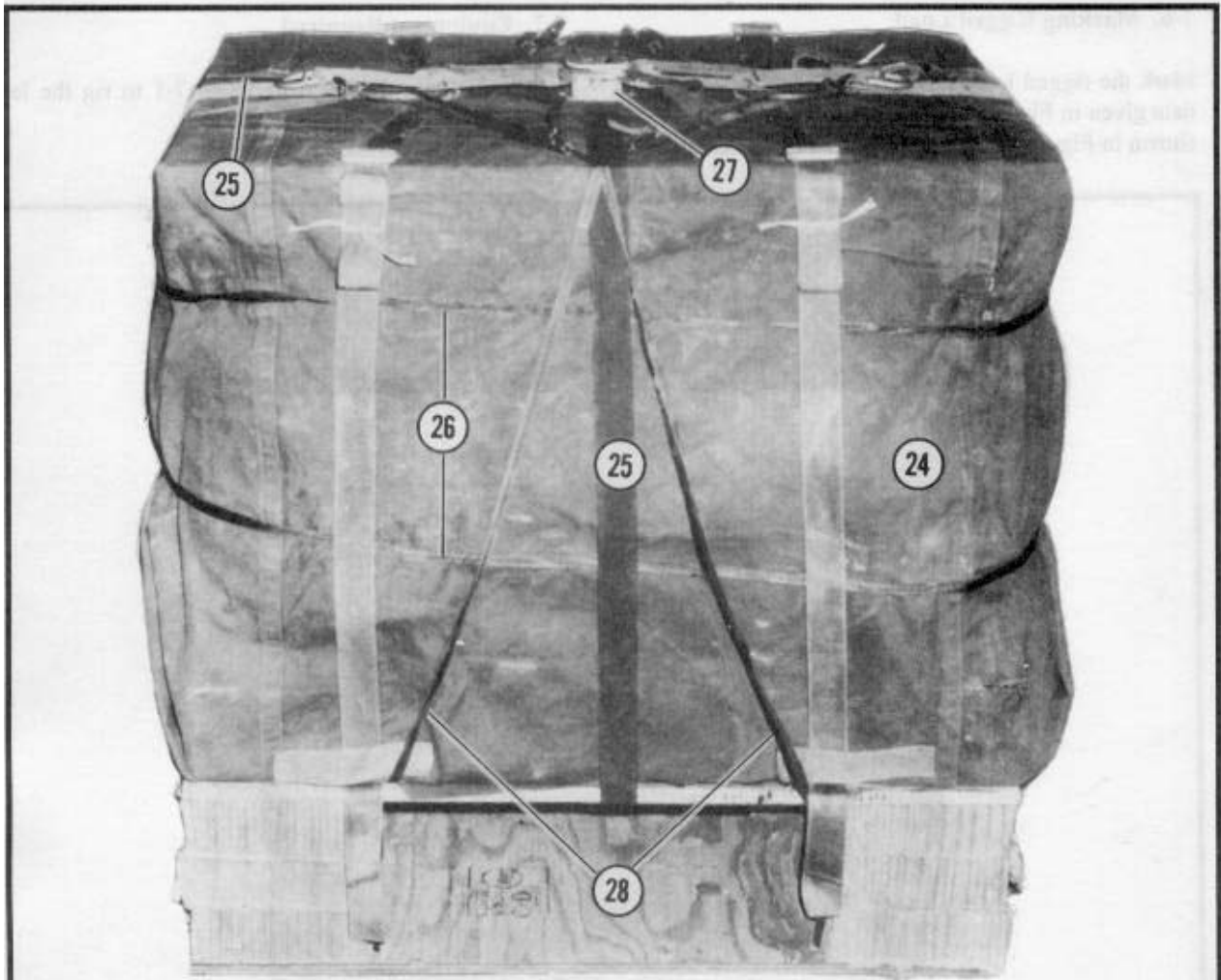

- 23 Using scrap pieces of honeycomb and other padding material, square off the top of the load. Place a 3/4- by 30- by 42-inch piece of plywood (not shown) on top of the load.
- 24 Fold the cover over the load. Fold under the excess cover.
- 25 Using two A-7A straps, route one of the straps between the skid board and the second piece of plywood from front to rear. Bring the strap over the load and secure it. Repeat step for the other strap, but route it from left to right.
- 26 Using two 14-foot lengths of 1/2-inch tubular nylon webbing, route one length around the load about one-third of the way up the load. Secure it tight with a trucker's hitch knot. Repeat step for second length two-thirds of the way up the load.
- 27 Finish closing the container according to Figure 6-2.
- 28 Secure the skid board to the load according to Figure 6-5.

Figure 7-3. GLLD rigged (continued)

7-6. Marking Rigged Load

Mark the rigged load according to Chapter 1 using the data given in Figure 7-4. If the load varies from the one shown in Figure 7-4, recompute the rigged load data.

7-7. Equipment Required

Use the equipment listed in Table 7-1 to rig the load shown in Figure 7-4.

CAUTION
 Make the final inspection required by Chapter 1 before the load leaves the rigging site. If the load includes hazardous material as defined in AFJMAN 24-204/TM 38-250, complete Shipper's Declaration for Dangerous Goods form.



RIGGED LOAD DATA	
Weight (with parachute)	395 pounds
Height (with parachute)	42 inches
Width	42 inches
Length	30 inches
Parachute	G-14

Figure 7-4. GLLD rigged in an A-21 cargo bag for low-velocity airdrop

Table 7-1. Equipment required for rigging the GLLD in an A-21 cargo bag for low-velocity airdrop

National Stock Number	Item	Quantity
8040-00-273-8713	Adhesive, paste, 1-gal	As required
1670-00-242-9173	Bag, cargo, A-21	1
8305-00-242-3593	Cloth, cotton duck, 60-in	As required
4020-00-240-2146	Cord, nylon, type III, 550-lb	As required
8135-00-664-6958	Cushioning material, packaging, cellulose wadding	As required
8305-00-958-3685	Felt, 1/2-in thick	As required
1670-00-753-3928	Pad, energy-dissipating, honeycomb, 3- by 36- by 96-in: 6- by 6-in 8- by 8-in 30- by 42-in	2 sheets (1) (12) (1)
1670-00-999-2658	Parachute, cargo, G-14	1
5530-00-128-4981	Plywood, 3/4- by 30- by 42-in	3
1670-00-251-1153	Sling assembly, cargo, airdrop, A-7A	1
7510-00-266-6710	Tape, masking, 2-in	As required
8310-01-102-4478	Thread, cotton, ticket number 8/7	As required
8305-00-268-2411	Webbing: Cotton, 1/4-in, type I	As required
8305-00-082-5752	Nylon, tubular, 1/2-in	As required

Section II

**RIGGING AIR TRAFFIC CONTROL FACILITY AN/TSQ-97A
FOR LOW-VELOCITY AIRDROP**

7-8. Description of Load

The ATCF AN/TSQ-97A contains three radios (AN/ARC-114A, AN/ARC-115A, and RT-1167/ARC-164(U)) and a control monitor (C9921/TSQ-97). The ATCF is rigged in an A-21 container for low-velocity airdrop. As shown in this section, the ATCF is rigged for paratroop door drop. The load

will weigh 292 pounds with parachute when it is completely rigged.

7-9. Preparing Load

Make sure all connections are tightened. Prepare the ATCF as shown in Figure 7-5.

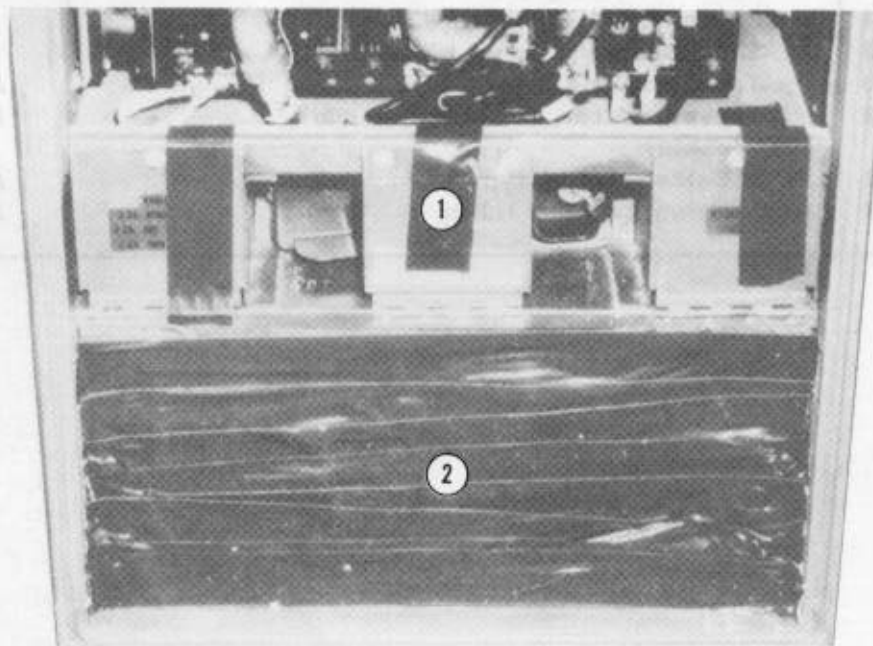

- ① Tape the accessory compartment doors. If necessary, fill compartments with cellulose wadding.
- ② Tape all of the lower compartment with adhesive tape.

Figure 7-5. ATCF prepared



Figure 7-5. ATCF prepared (continued)

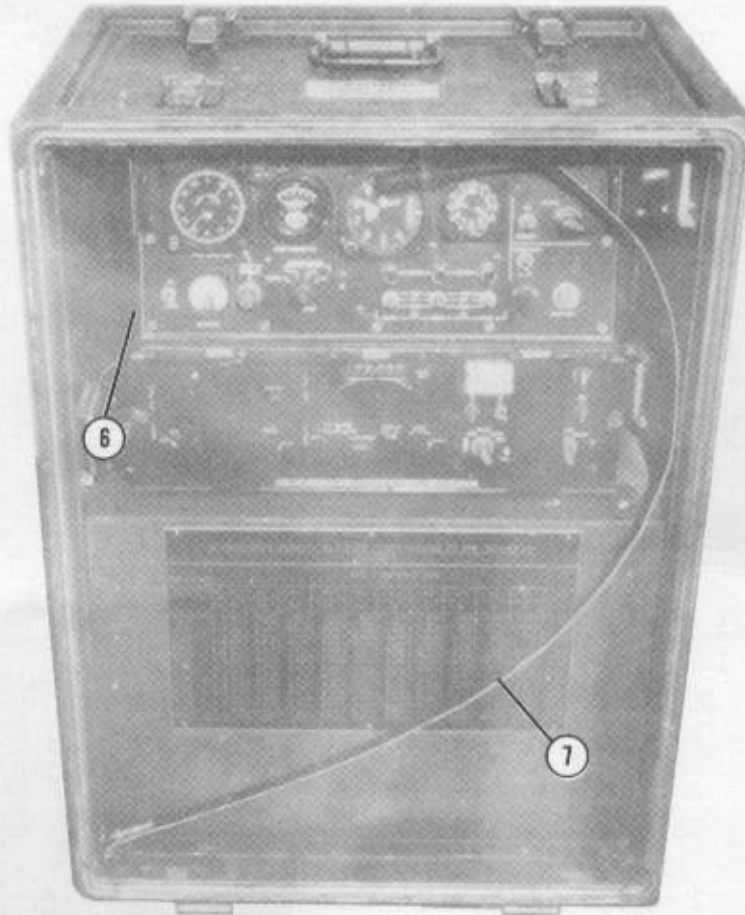

- ⑤ Make sure mounting bolts (not shown) securing the radios are secured.
- ⑥ Tape the plastic radio shield in place. Ensure the plastic shield straps are in place.
- ⑦ Place the antenna in the compartment.
- ⑧ Place a 22 1/2- by 32 1/2-inch piece of felt (not shown) over the unit.
- ⑨ Place the front cover on the load. Make sure the locking latches are locked and the quick-release pins are secured on the sides of the box (not shown).

Figure 7-5. ATCF prepared (continued)

7-10. Preparing Skid Board

Prepare the skid board as shown in Figure 7-6.

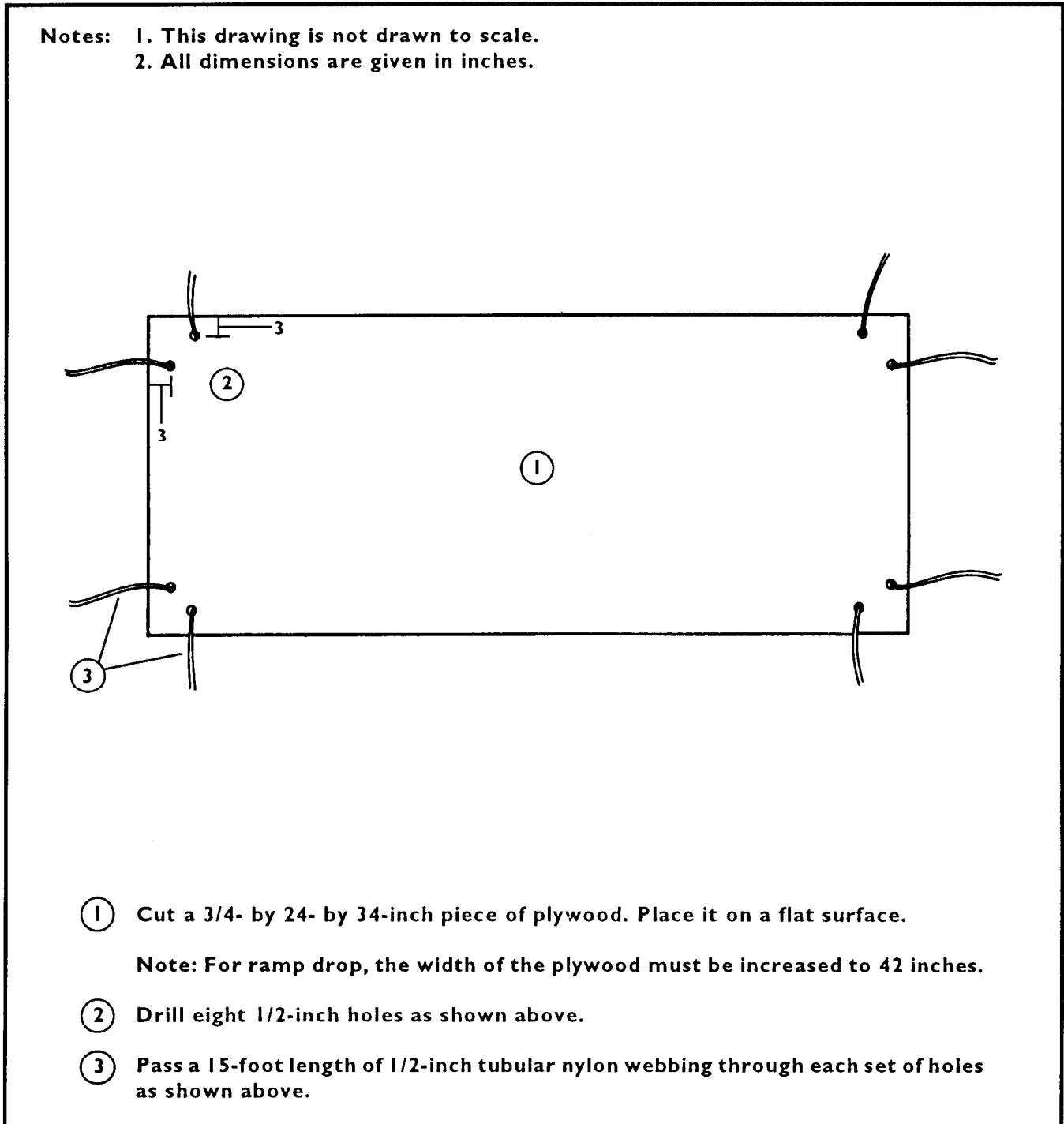
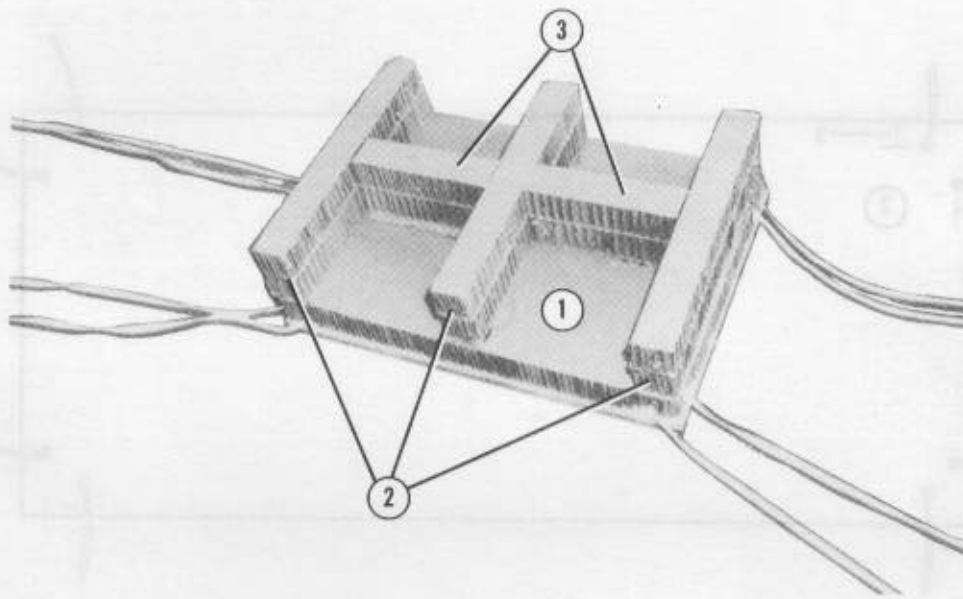

Figure 7-6. ATCF skid board prepared

7-11. Positioning Honeycomb

Position the honeycomb as shown in Figure 7-7.



- ① Center a 24- by 34-inch piece of honeycomb on the skid board.
- ② Cut six 3- by 24-inch pieces of honeycomb. Place the honeycomb in three stacks (two pieces each). Center one other stack on top of the honeycomb. Place one stack even with each side edge.
- ③ Cut four 3- by 12-inch pieces of honeycomb. Place the honeycomb in two stacks (two pieces each). Center one stack (front to rear) between the two stacks. Center the other stack (front to rear) on the other side.

Figure 7-7. Honeycomb positioned

7-12. Placing Container

Place the container on a flat surface. Make sure the scuff pad is positioned under the cover.

7-13. Positioning Load

Position the load as shown in Figure 7-8.

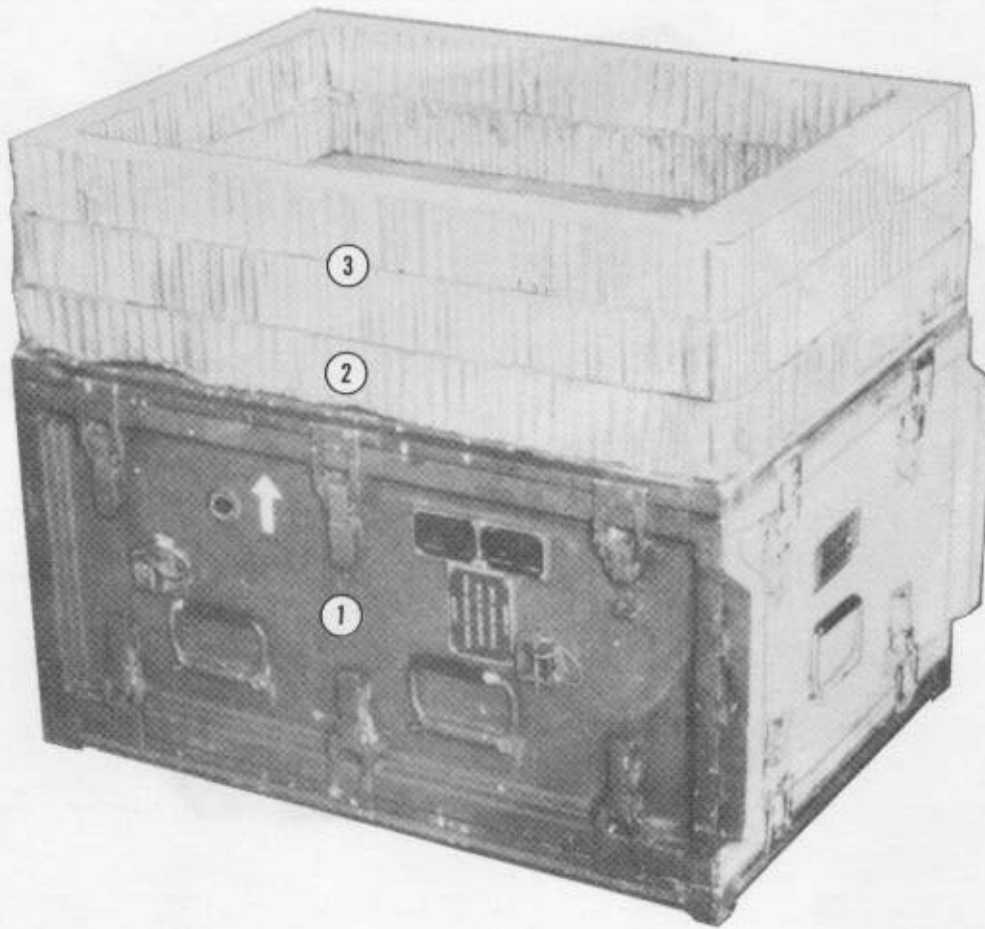

- ① Center the load on the A-21 container.
- ② Center a 24- by 34-inch piece of honeycomb on top of the load.
- ③ Cut two 24- by 34-inch pieces of honeycomb. Make a 20- by 30-inch cutout in the middle of each piece of honeycomb. Center both pieces of honeycomb on top of the first layer of honeycomb.

Figure 7-8. Load positioned

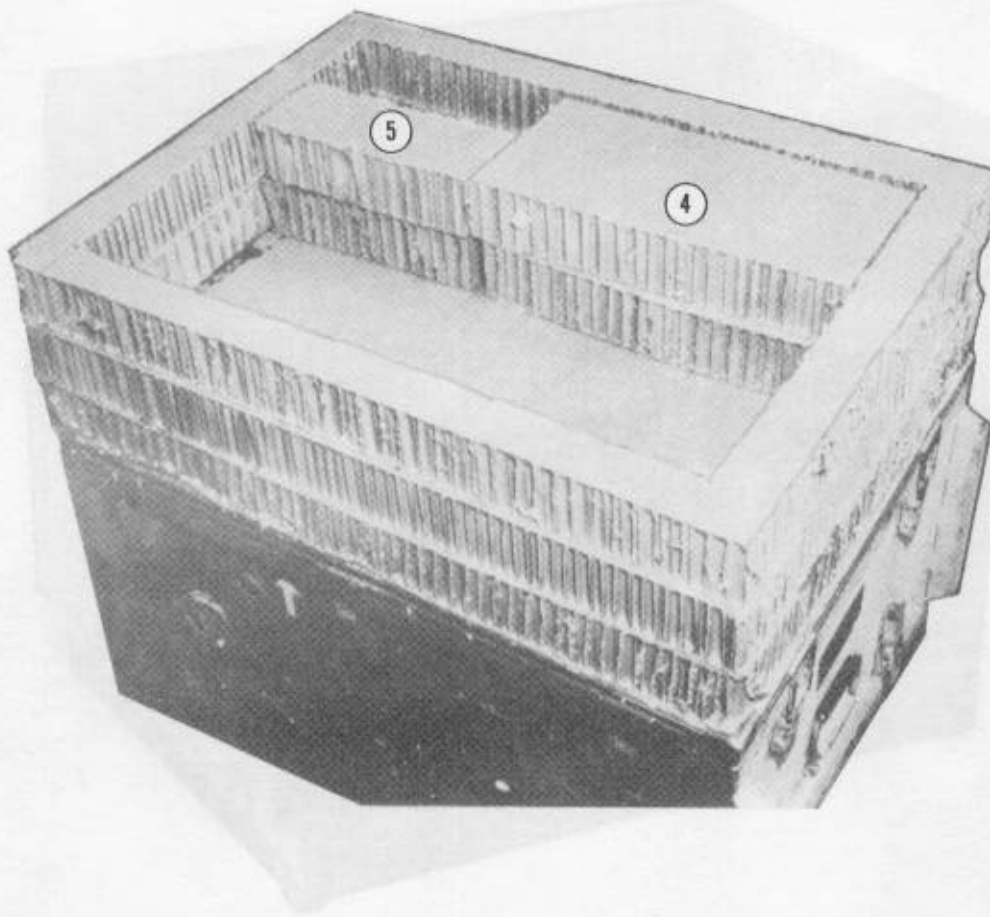

- ④ Cut two 9- by 18-inch pieces of honeycomb. Place them in the upper right corner of the cutout portion of honeycomb layers 2 and 3.
- ⑤ Cut two 12- by 4-inch pieces of honeycomb. Place them in the upper left corner of the cutout portion of honeycomb layers 2 and 3, flush with the front of the 9- by 18-inch pieces.

Figure 7-8. Load positioned (continued)

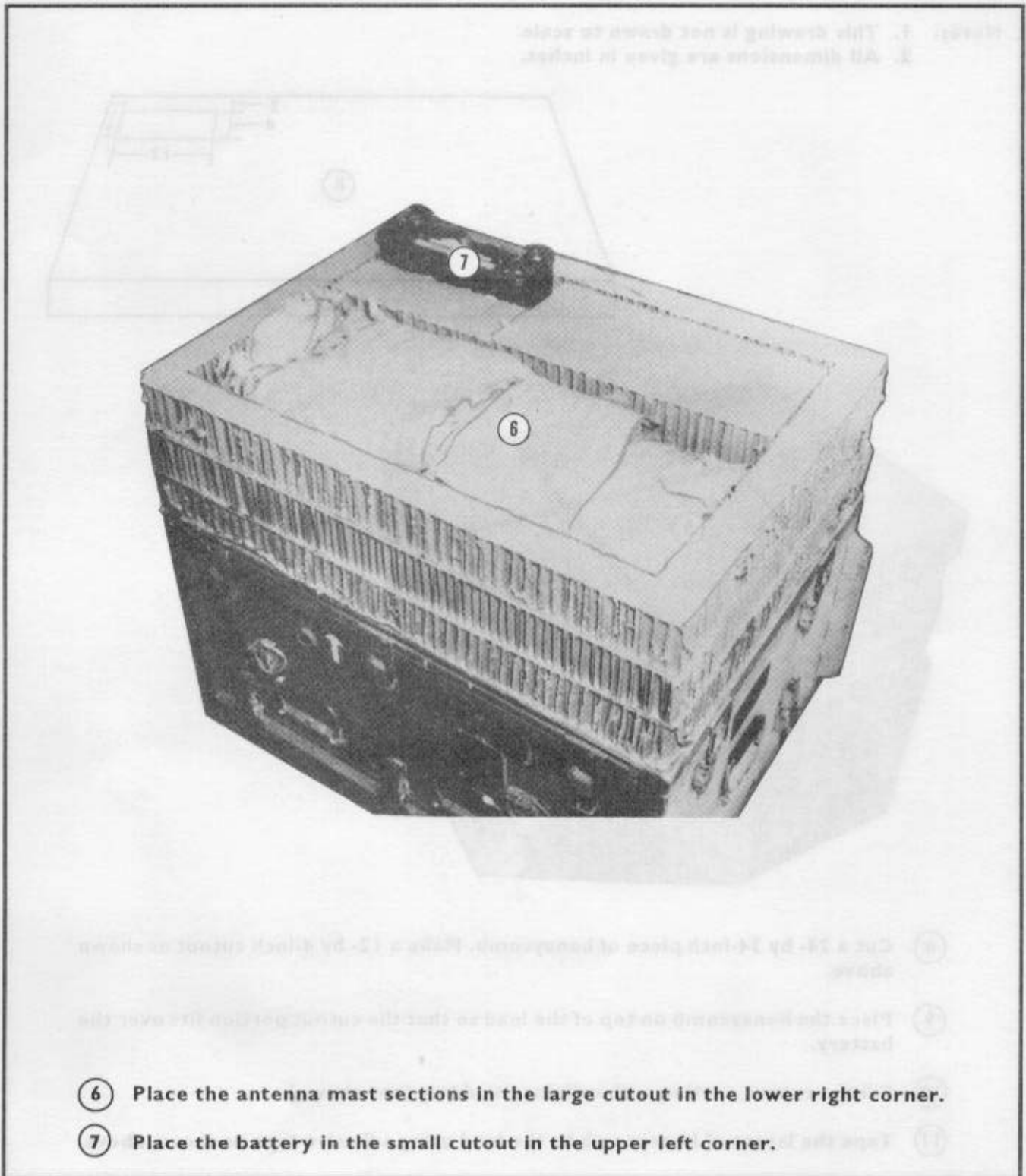

- ⑥ Place the antenna mast sections in the large cutout in the lower right corner.
- ⑦ Place the battery in the small cutout in the upper left corner.

Figure 7-8. Load positioned (continued)

- Notes: 1. This drawing is not drawn to scale.
2. All dimensions are given in inches.

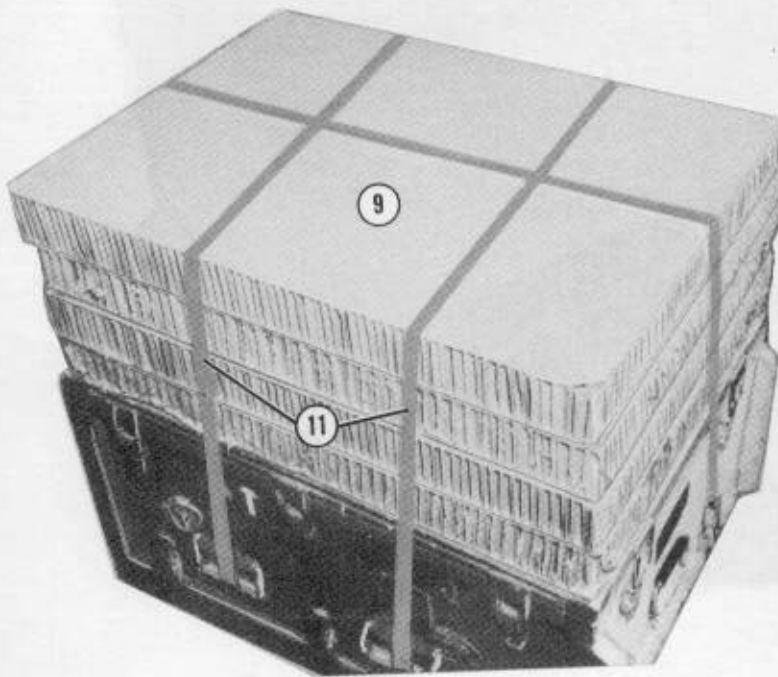
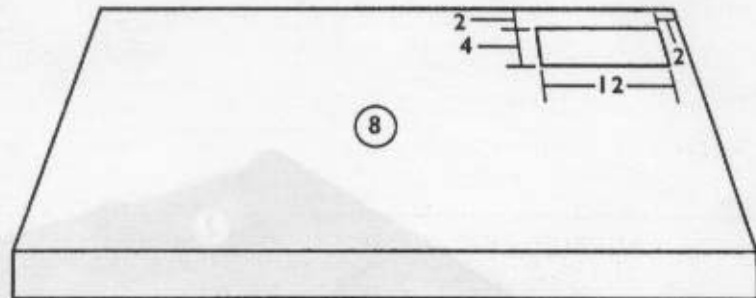

- ⑧ Cut a 24- by 34-inch piece of honeycomb. Make a 12- by 4-inch cutout as shown above.
- ⑨ Place the honeycomb on top of the load so that the cutout portion fits over the battery.
- ⑩ Fill the cutout portion with cellulose wadding (not shown).
- ⑪ Tape the layers of honeycomb to the load using adhesive tape as shown above.

Figure 7-8. Load positioned (continued)

7-14. Rigging Container

Rig the container according to Figure 6-2. Place the container on the honeycomb prepared in Figure 7-7. Secure the skid board to the container as shown in Figure 6-5.

7-15. Installing Parachute

Install the G-14 cargo parachute according to Chapter 5.

7-16. Marking Rigged Load

Mark the rigged load according to Chapter 1 using the data given in Figure 7-9. If the load varies from the one shown in Figure 7-9, recompute the rigged load data.

7-17. Equipment Required

Use the equipment listed in Table 7-2 to rig the load shown in Figure 7-9.

CAUTION

Make the final inspection required by Chapter 1 before the load leaves the rigging site. If the load includes hazardous material as defined in AFJMAN24-204/TM 38-250, complete Shipper's Declaration for Dangerous Goods form.

**RIGGED LOAD DATA**

Weight (with parachute)	292 pounds
Height (with parachute)	55 inches
Width	24 inches
Length	34 inches
Parachute	G-14

Figure 7-9. ATCF rigged for low-velocity airdrop

Table 7-1. Equipment required for rigging the ATCF for low-velocity airdrop

National Stock Number	Item	Quantity
8040-00-273-8713	Adhesive, paste, 1-gal	As required
1670-00-242-9173	Bag, cargo, A-21	1
8135-00-664-6958	Cushioning material, packaging,	
	cellulose wadding	As required
8305-00-958-3685	Felt, 1/2-in thick	As required
1670-00-753-3928	Pad, energy-dissipating, honeycomb,	
	3- by 36- by 96-in:	2 sheets
	3- by 12-in	(4)
	3- by 24-in	(6)
	9- by 18-in	(2)
	12- by 4-in	(2)
	24- by 34-in	(5)
1670-00-999-2658	Parachute, cargo, G-14	1
5530-00-128-4981	Plywood, 3/4- by 48- by 96-in	1 sheet
8305-00-074-5124	Tape, adhesive, 2-in	As required
	Webbing:	
8305-00-268-2411	Cotton, 1/4-in, type I	As required
8305-00-082-5752	Nylon, tubular, 1/2-in	As required

PART FOUR RIGGING A-22 CONTAINER LOADS

CHAPTER 8 GENERAL INFORMATION FOR A-22 LOADS

8-1. A-22 Cargo Bag Assembly

The A-22 cargo bag assembly, shown in Figure 8-1, is an adjustable cotton duck cloth/nylon and nylon webbing container. It consists of a sling assembly, a cover, and four suspension webs. The load may be rigged with or without the cover.

8-2. A-22 Skid Board

CAUTION: When the skid board is locally fabricated, AC grade plywood must be used. Make sure the smooth side is facing down on the rollers.

The standard skid board is 1 by 48 by 48 inches for both low- and high-velocity drops. When dropping low-velocity loads weighing 501 to 1,600 pounds, the 3/4-inch thick skid board may be used. The skid board has sixteen 1/2-inch holes (four in each side), which are used to secure the skid board to the load. The skid board ties are made of 1/2-inch (or 5/8-inch) tubular nylon webbing. The length will vary according to the layers of honeycomb. Steel strapping will not be used to secure the skid board to the load unless specific rigging procedures authorize it.

NOTE 1: The steel strapping must not touch the aircraft's rollers.

NOTE 2: For loads using a 48- by 53 1/2-inch skid board, 53 1/2- by 96-inch skid board, or steel strapping on skid board, see paragraph 2-6 and Table 2-4.

8-3. A-22 Container Limitations

The A-22 load has a weight restriction of 501 to 2,200 pounds, excluding the weight of the parachute. Ensure the load weighs the minimum of 28 pounds per square foot. The height of the load will not exceed 83 inches unless specific rigging procedure authorizes it. The width of the load must not exceed 48 inches.

NOTE : If the load is smaller than the length of the skid board, place honeycomb filler sheets vertically inside the A-22 container. The length of the A-22 container should equal the length of the skid board. This prevents the A-22 containers from shifting when the loads are restrained in the aircraft.

NOTE : Any overhang must be placed lengthwise in the aircraft.

8-4. Double A-22 Cargo Bag

The double A-22 cargo bag is made using two A-22 cargo bags. The skid board is constructed of a 1- by 48- by 96-inch piece of plywood. When dropping loads weighing 900 to 1,600 pounds, the 3/4-inch thick skid board may be used. The skid board has twenty-four 1/2-inch holes used for skid board ties. Ensure the load weighs the minimum of 28 pounds per square foot. This load will also be rigged with the double "X" skid board ties.

CAUTION: When rigging double A-22 loads, make sure cotton and nylon sling assemblies are NOT mixed.

8-5. Stretch A-22 Cargo Bag

The stretch A-22 cargo bag is made using two A-22 cargo bags. The skid board is constructed of a 1- by 48- by 72-inch piece of plywood. When dropping loads weighing 900 to 1,600 pounds, the 3/4-inch thick skid board may be used. The skid board has twenty-four 1/2-inch holes used for skid board ties. Ensure the load weighs the minimum of 28 pounds per square foot. This load will also be rigged with the double "X" skid board ties.

8-6. Assembly Line Rigging

When assembly line rigging is used for A-22 loads, only five stations are needed. FM 10-500-9 covers setting up the rigging line and stations. The five stations are laying out containers and preparing base, positioning load, rigging load, installing parachute, and inspecting the rigged load.

8-7. Inspection of Load

The A-22 load must be inspected by a qualified rigger. While being rigged, this load should be supervised or rigged by a parachute rigger. DD Form 1748-1 must be completed before airdrop.

8-8. Parachutes Used

There are two types of parachutes used for A-22 loads, depending on whether the load is being dropped for low or high velocity. Each category has a primary and alternate parachute. The alternate should be used only when the primary is not available.

a. Low-Velocity Drops.

(1) *Primary Parachute.* The G-12E cargo parachute is the primary parachute for A-22 loads dropped at low velocity. It is rated for 501 to 2,200 pounds of suspended weight. A 68-inch pilot parachute is installed on the G-12E cargo parachute to deploy it. Other parachutes may be used to deploy the G-12E cargo parachute; however, the specific manual must give the procedures. TM 10-1670-281- 23&P/TO 13C5-32-2 covers the inspection and packing of the G-12E cargo parachute and its 68- inch pilot parachute.

NOTE: Suspended weight is the total weight of the load without the parachute attached.

(2) *Alternate Parachute.* The G-14 cargo parachute is the alternate parachute for A-22 loads dropped for low velocity. It is used in a two or three cluster. The two cluster is for loads 501 to 1,000 pounds of suspended weight and the three cluster is for loads 1,001 to 1,500 pounds of suspended weight. TM 10-1670-282-23&P/TO 13C5-30-2 covers the inspection and packing of the G-14 cargo parachute.

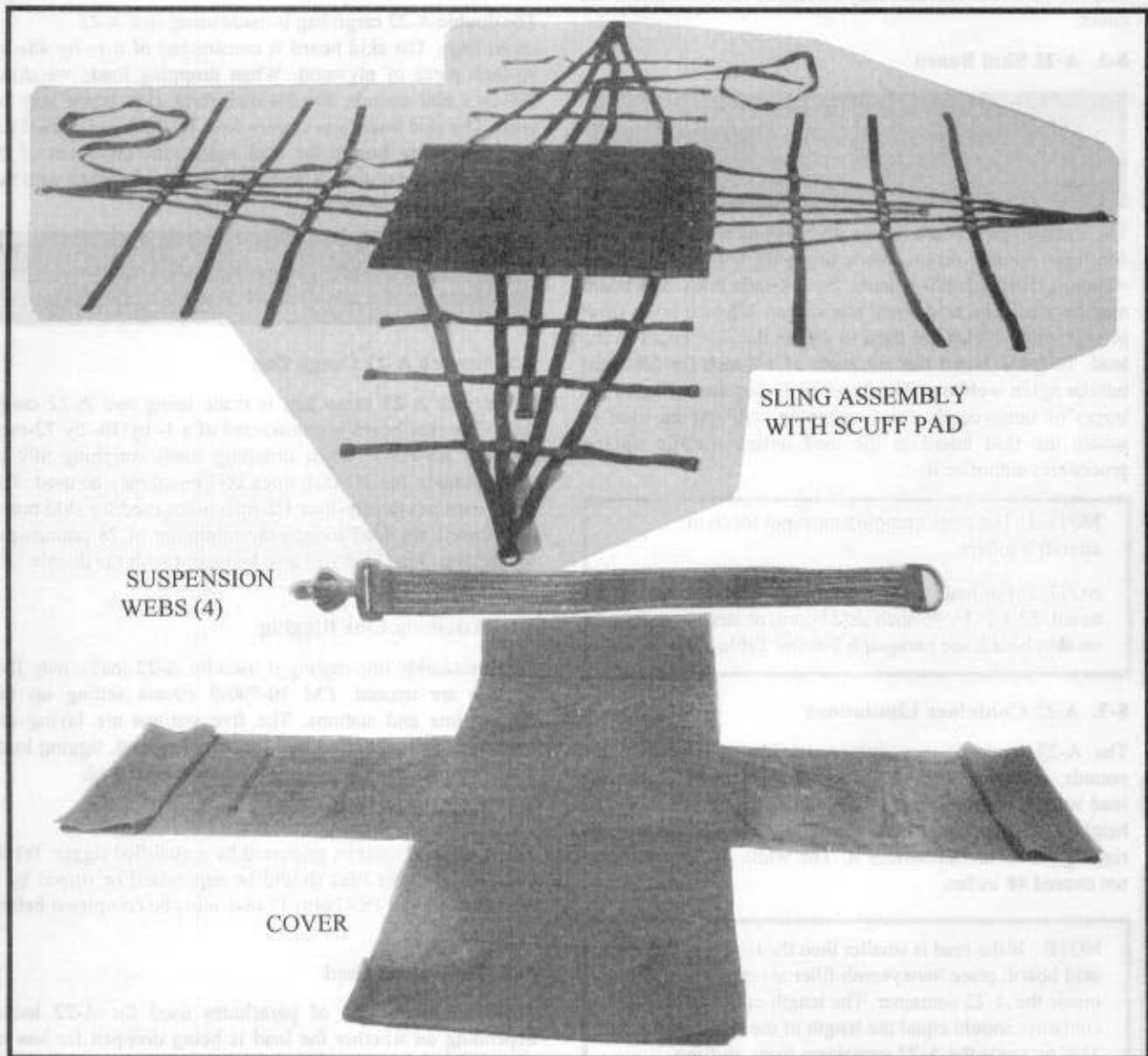

Figure 8-1. A-22 cargo bag

b. High-Velocity Drops.

NOTE: High-velocity CDS must be rigged with breakaway static lines.

(1) *Primary Parachute.* The 26-foot, high-velocity cargo parachute is the primary parachute for high-velocity A-22 load drops. The parachute is rated from 501 to 2,200 pounds. TM 10-1670-276-23&P/TO 13C5-29-2 covers the inspection and packing of the parachute.

(2) *Alternate Parachute.* The 22-foot cargo extraction parachute is the alternate parachute for A-22 high-velocity drop loads. It is rated for 501 to 2,200 pounds of suspended weight. TM 10-1670-279-23&P/TO 13C5-27-2 covers the inspection and packing of the parachute.

8-9. Installation of Parachutes

Parachutes should be installed as follows:

a. To install the G-12E cargo parachute, refer to Figure 8-2.

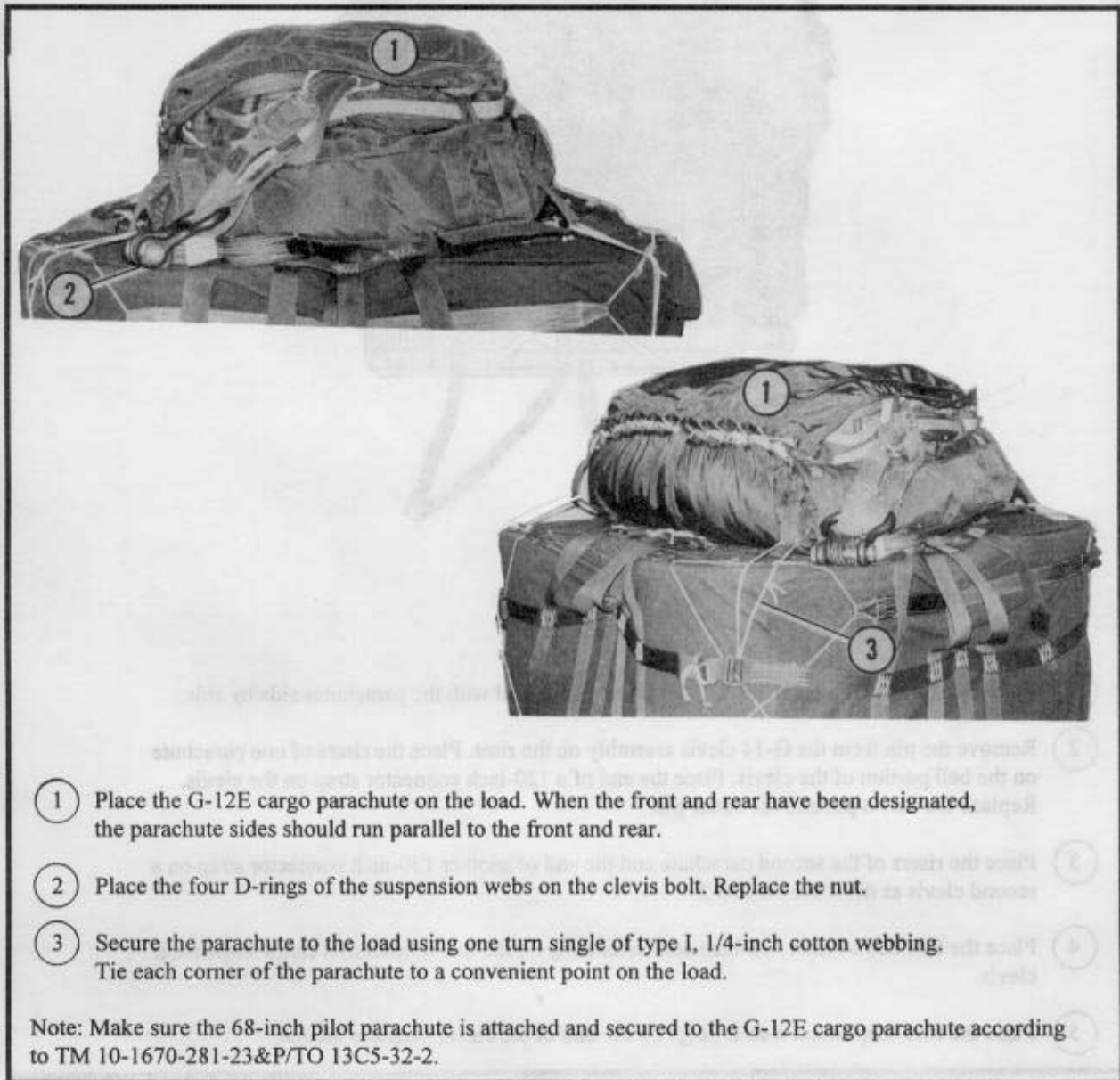
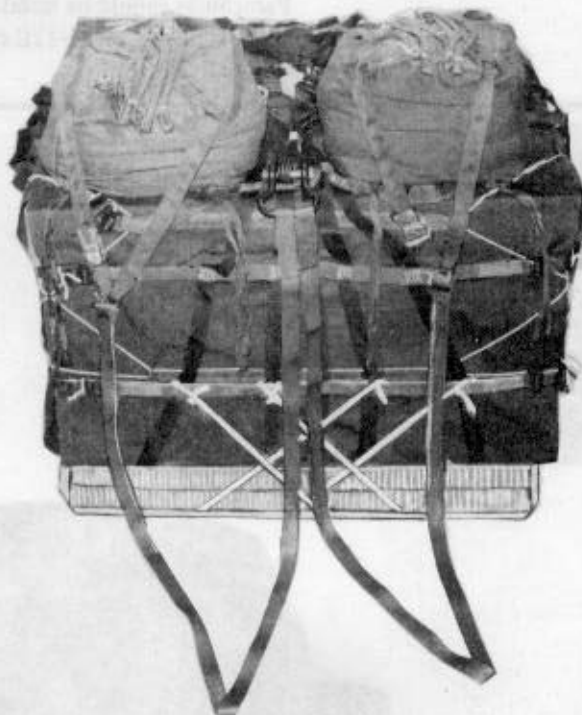

Figure 8-2. G-12E cargo parachute installed

b. To install two G-14 cargo parachutes, refer to Figure 8-3.



- 1 Place two G-14 cargo parachutes on the front of the load with the parachutes side by side.
- 2 Remove the pin from the G-14 clevis assembly on the riser. Place the risers of one parachute on the bell portion of the clevis. Place the end of a 120-inch connector strap on the clevis. Replace the clevis pin and the cotter pin.
- 3 Place the risers of the second parachute and the end of another 120-inch connector strap on a second clevis as described in step 2.
- 4 Place the free end of each 120-inch connector strap on the bell portion of a cargo suspension clevis.
- 5 Place the four suspension web D-rings on the bolt of the clevis. Replace the nut.

Figure 8-3. Two G-14 cargo parachutes installed

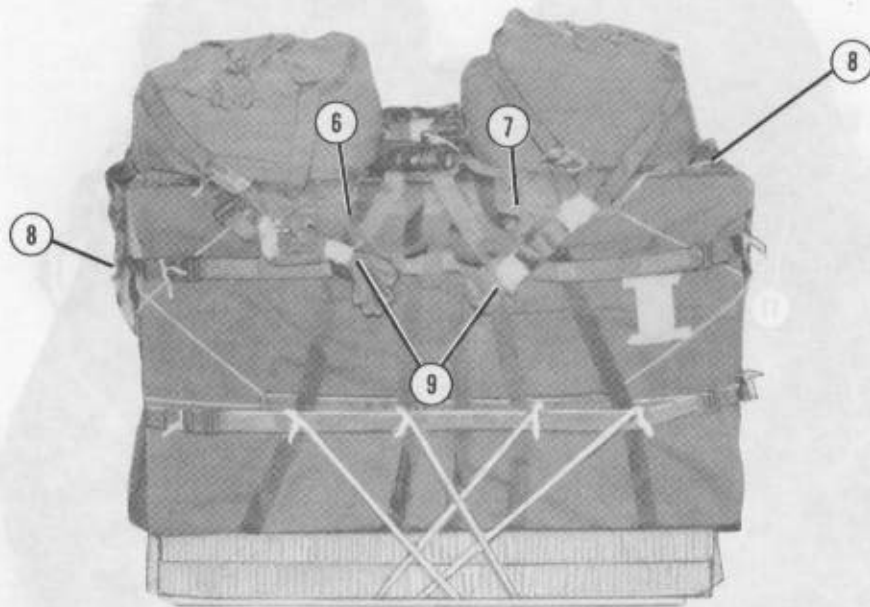

- ⑥ Tie the front center tie tapes of one parachute to a convenient point on the front of the load.
- ⑦ Tie the front center tie tapes of the other parachute to a convenient point on the front of the load.
- ⑧ Tie the front outside tie tape of each parachute to a convenient point on the load.
- ⑨ Fold the excess connector strap, and secure the folds with tape. Tie the folds to the front of the load with a double length of type I, 1/4-inch cotton webbing.

Figure 8-3. Two G-14 cargo parachutes installed (continued)

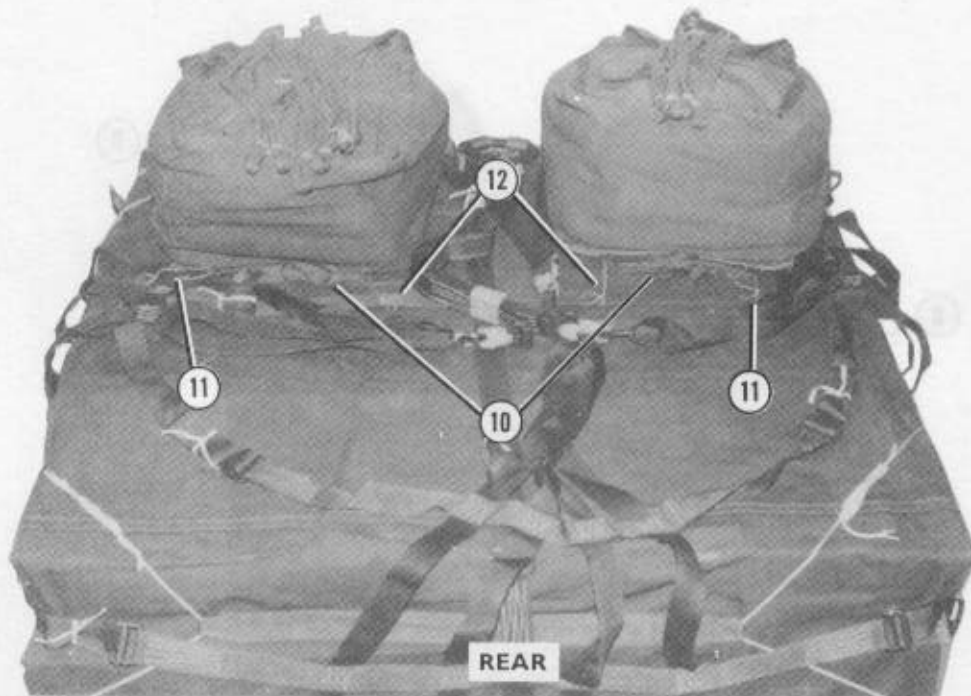

- ⑩ Tie the rear tapes of each parachute together.
- ⑪ Pass a length of ticket number 8/7 cotton thread through the outside tie loop of each parachute. Tie the ticket number 8/7 cotton thread to a convenient point on the load.
- ⑫ Pass a length of ticket number 8/7 cotton thread through the inside tie loop of each parachute. Tie the ticket number 8/7 cotton thread to a convenient point on the load.

Notes: 1. Two 9-foot (2-loop) slings may be used in place of the two 120-inch connector straps. However, one sling and one strap may not be used.
2. Tape the clevis pin and other sharp edges.

Figure 8-3. Two G-14 cargo parachutes installed (continued)

c. To install three G-14 cargo parachutes, refer to Figure 8-4.

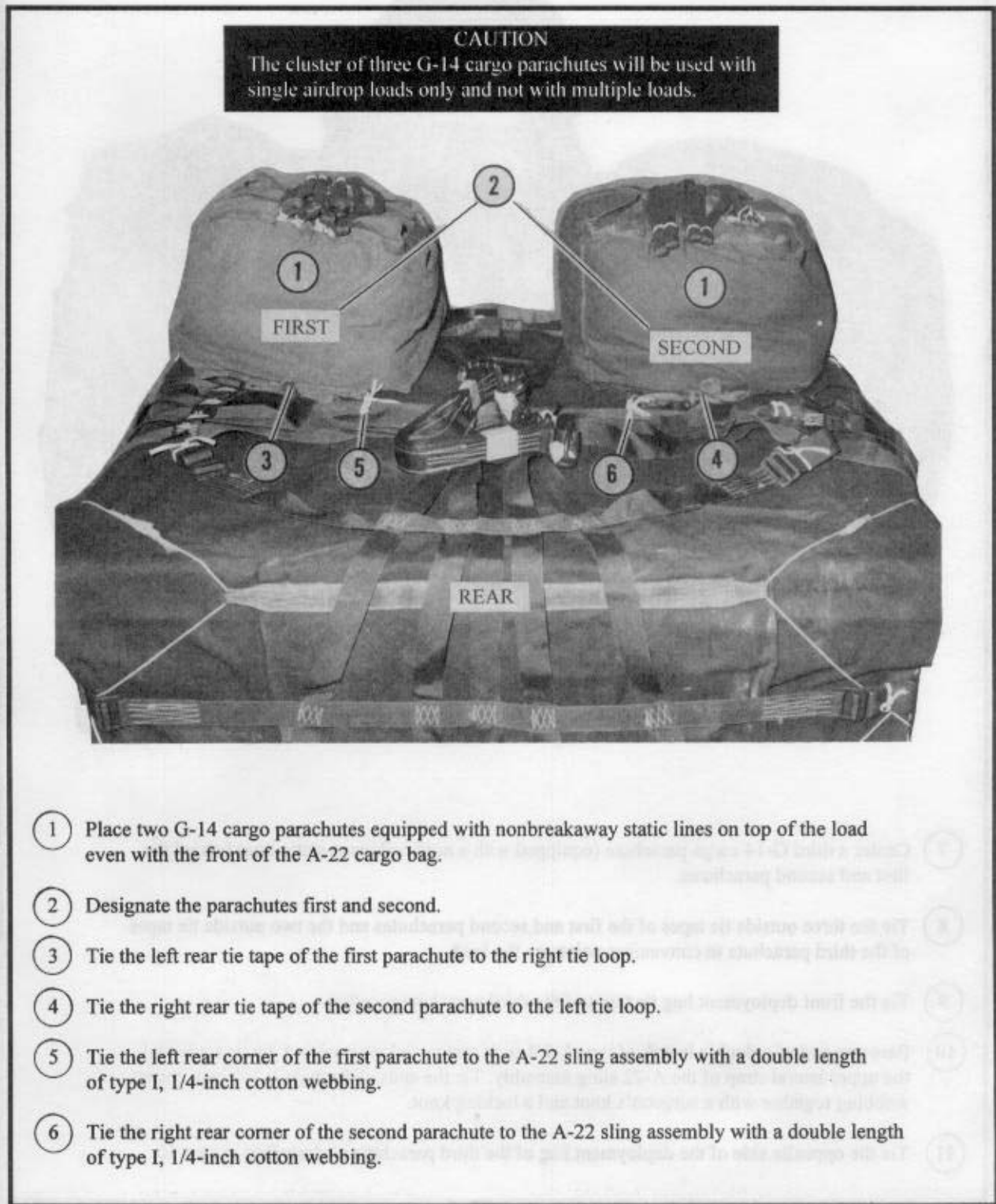
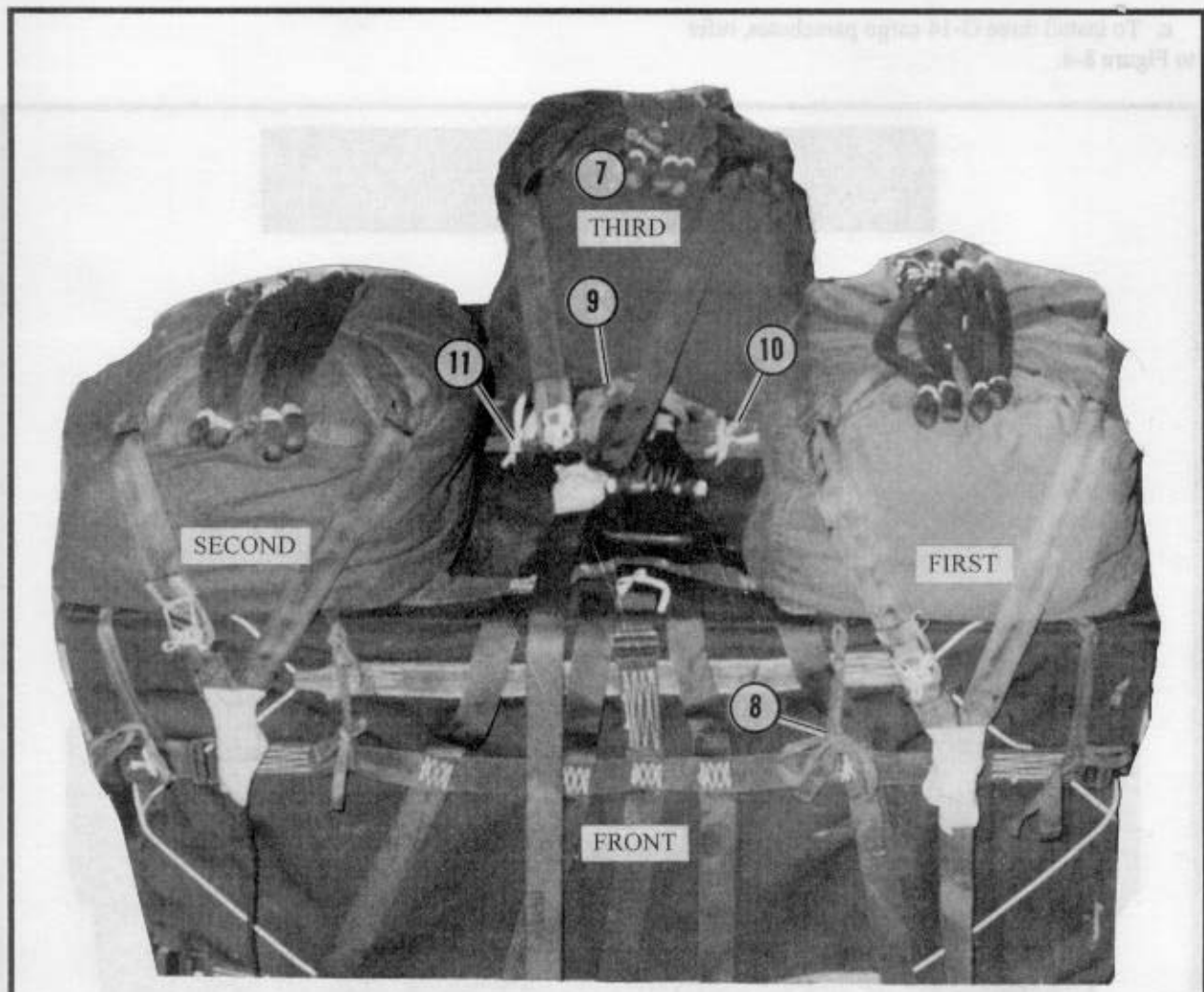
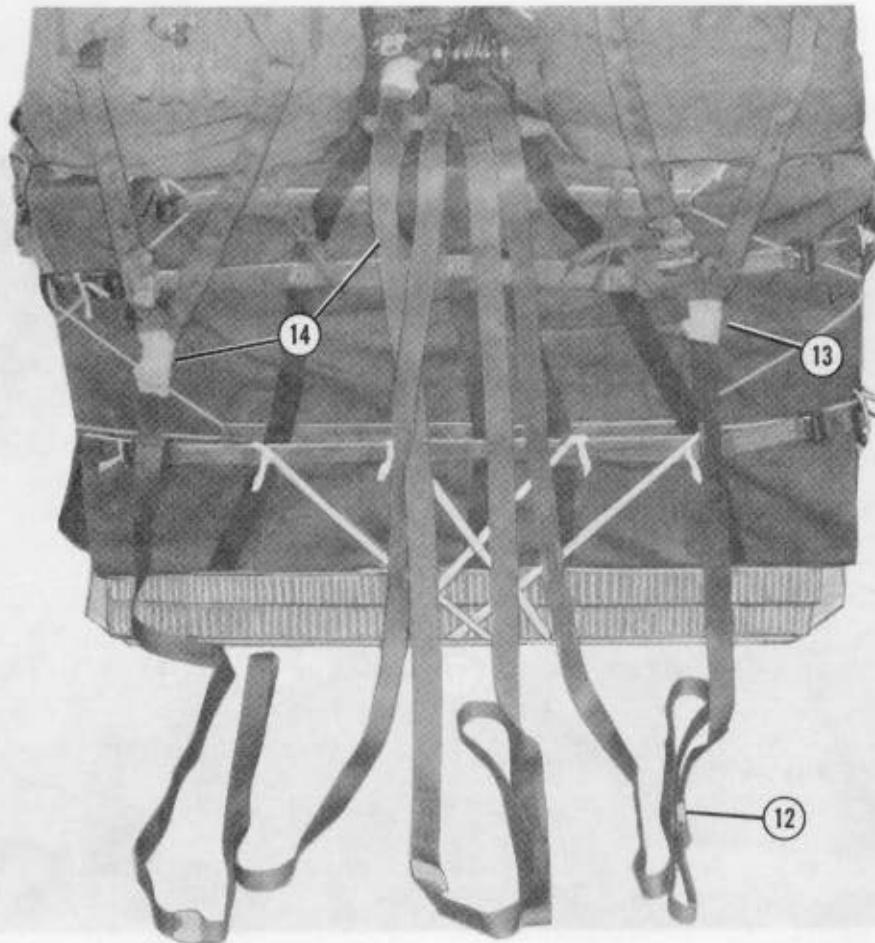

Figure 8-4. Three G-14 cargo parachutes installed



- 7 Center a third G-14 cargo parachute (equipped with a nonbreakaway static line) behind the first and second parachutes.
- 8 Tie the three outside tie tapes of the first and second parachutes and the two outside tie tapes of the third parachute to convenient points on the load.
- 9 Tie the front deployment bag tie tapes of the third parachute together.
- 10 Pass one end of a double length of type I, 1/4-inch cotton webbing around the tie tapes and the upper lateral strap of the A-22 sling assembly. Tie the ends of the type I, 1/4-inch cotton webbing together with a surgeon's knot and a locking knot.
- 11 Tie the opposite side of the deployment bag of the third parachute as described in step 10.

Figure 8-4. Three G-14 cargo parachutes installed (continued)



- ⑫ Form a 180-inch riser extension by connecting a 60-inch connector strap and a 120-inch connector strap with an L-bar connector link. Cover the L-bar connector link with tape.
- ⑬ Connect the risers of the first parachute to one end of the 180-inch riser extension with a G-14 clevis assembly. Cover the G-14 clevis assembly with tape.
- ⑭ Form a second and third riser extension as described in step 12. Fasten the second and third riser extensions to the second and third parachutes as described in step 13.

Figure 8-4. Three G-14 cargo parachutes installed (continued)

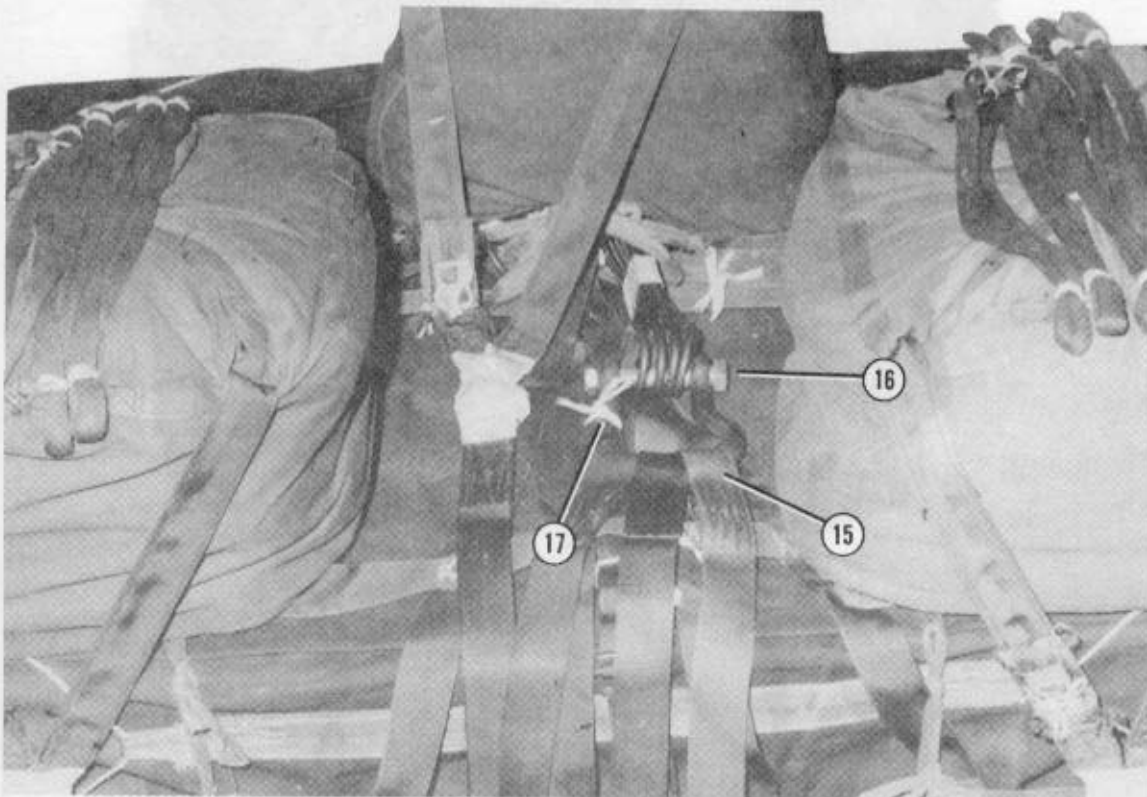

- ⑮ Place the bell portion of a cargo suspension clevis on the free ends of the riser extensions.
- ⑯ Place the A-22 sling assembly D-rings on the bolt of the cargo suspension clevis. Replace the nut.
- ⑰ Tie the cargo suspension clevis to the A-22 sling assembly with a double length of type I, 1/4-inch cotton webbing.

Figure 8-4. Three G-14 cargo parachutes installed (continued)

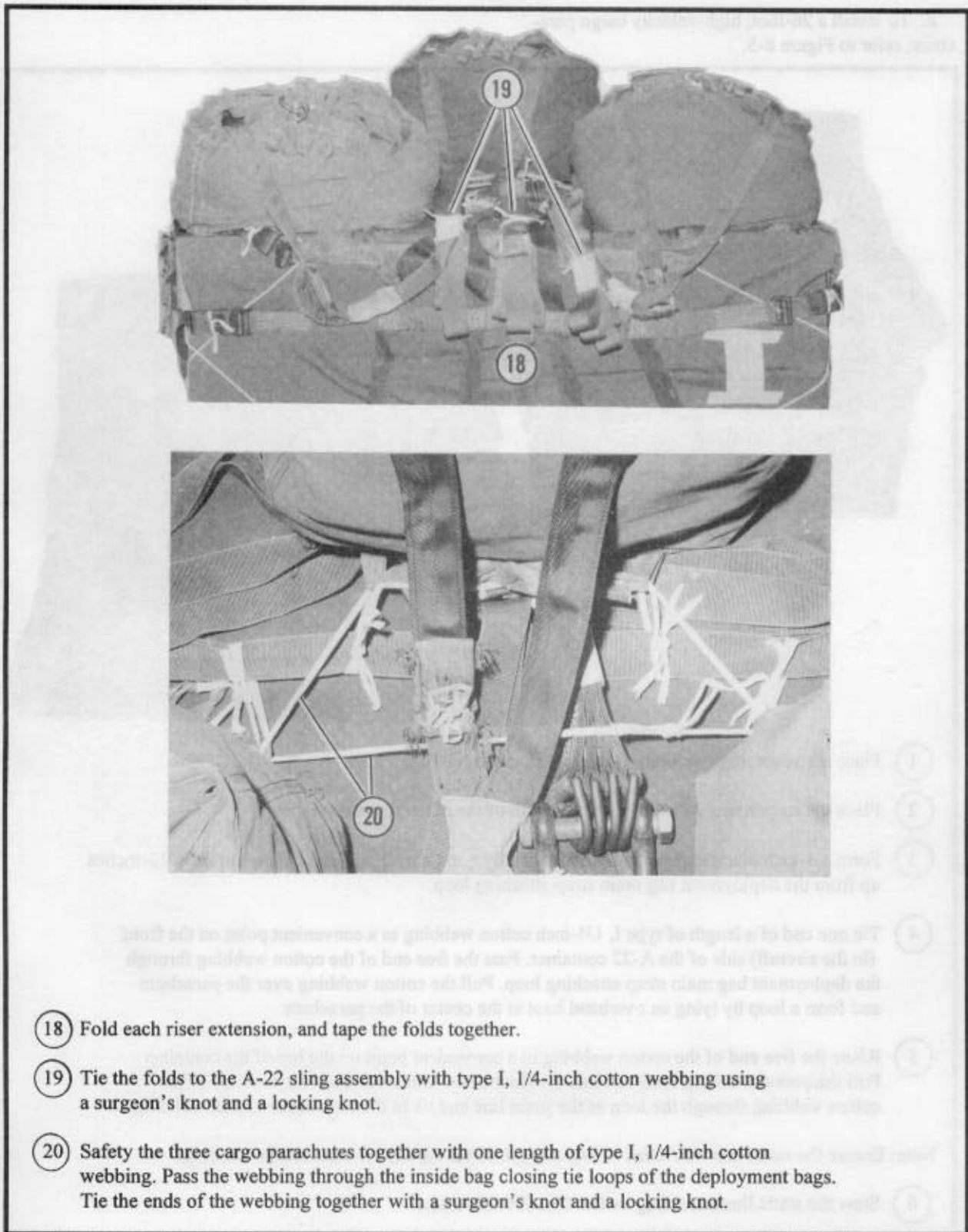

- ⑱ Fold each riser extension, and tape the folds together.
- ⑲ Tie the folds to the A-22 sling assembly with type I, 1/4-inch cotton webbing using a surgeon's knot and a locking knot.
- ⑳ Safety the three cargo parachutes together with one length of type I, 1/4-inch cotton webbing. Pass the webbing through the inside bag closing tie loops of the deployment bags. Tie the ends of the webbing together with a surgeon's knot and a locking knot.

Figure 8-4. Three G-14 cargo parachutes installed (continued)

d. To install a 26-foot, high-velocity cargo parachute, refer to Figure 8-5.

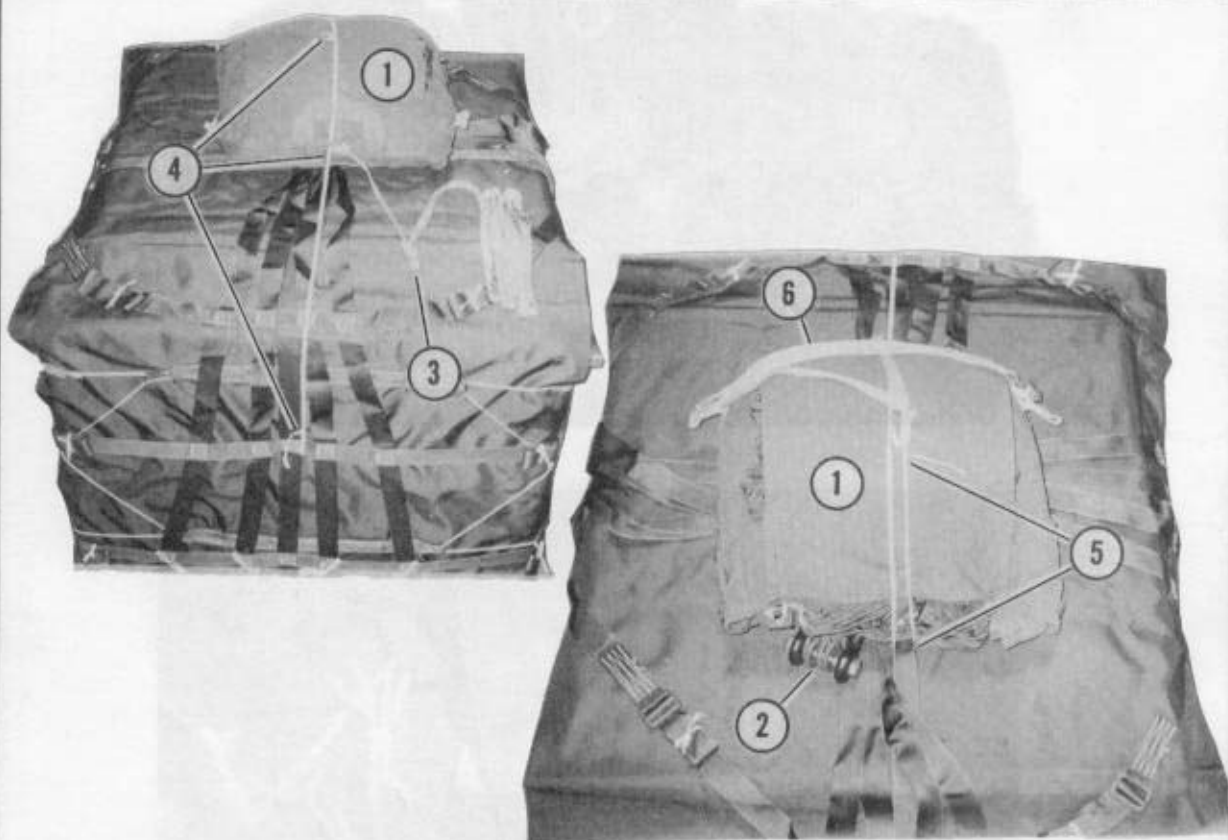

- ① Place a 26-foot, high-velocity cargo parachute on top of the load.
- ② Place the suspension web D-rings on the bolt of the cargo suspension clevis .
- ③ Form a 3-inch diameter loop in the static line by tying a overhand knot approximately 12-inches up from the deployment bag main strap attaching loop.
- ④ Tie one end of a length of type I, 1/4-inch cotton webbing to a convenient point on the front (in the aircraft) side of the A-22 container. Pass the free end of the cotton webbing through the deployment bag main strap attaching loop. Pull the cotton webbing over the parachute and form a loop by tying an overhand knot at the center of the parachute.
- ⑤ Route the free end of the cotton webbing to a convenient point on the top of the container. Pull the cotton webbing back towards the front of the container. Pass the free end of the cotton webbing through the loop of the static line and tie to the loop of the cotton webbing.

Note: Ensure the static line will break a single length of the type I, 1/4-inch cotton webbing.

- ⑥ Stow the static line according to TM 10-1670-276-23&P.

Figure 8-5. One 26-foot, high-velocity cargo parachute installed

e. To install a 22-foot cargo extraction parachute, refer to Figure 8-6.



- ① Modify the 22-foot cargo extraction parachute by adapting the procedures in Figure 3-6 for modifying the 15-foot cargo extraction parachute. Install a 20-foot (2-loop), type XXVI nylon webbing sling as shown in Figure 3-6, steps 7 through 10. Place the parachute on top of the load.
- ② Place the suspension web D-rings on the bolt of the cargo suspension clevis on the end of the 20-foot sling. Replace the bolt.
- ③ S-fold the 20-foot sling on top of the load, and tie the folds together with two lengths of type I, 1/4-inch cotton webbing.

Figure 8-6. One 22-foot cargo extraction parachute installed

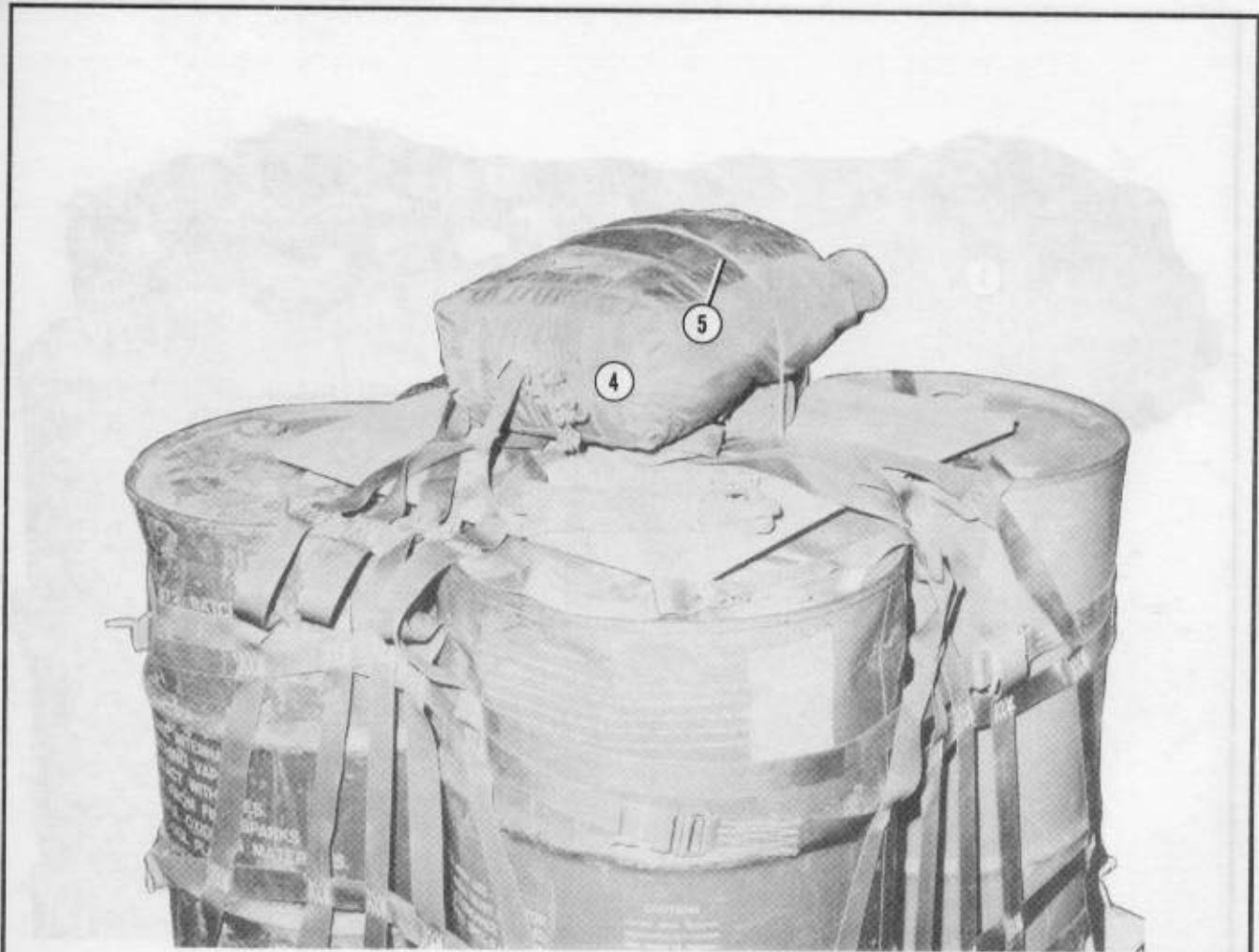

- ④ Center the parachute on top of the load.
- ⑤ Tie a length of type I, 1/4-inch cotton webbing to a convenient point on the load. Pass the free end of the webbing over the parachute, and pull the webbing tight. Tie the free end of the type I, 1/4-inch cotton webbing to a convenient point on the load.

Figure 8-6. One 22-foot cargo extraction parachute installed (continued)

8-9. Purpose of Waiver for Non-CVRS and G-12D Cargo Parachute Loads

This waiver is granted to allow air items currently rigged reasonable time to be used or rerigged during regular repack or rerigging cycles. Every effort should be made to convert to new rigging standards in a timely manner. The new rigging standards are designed to increase the survivability of both airdropped items and the aircraft used to deliver the items. Paragraph 8-10 and Table 8-1 state the limitations of non-CVRS and G-12D cargo parachute loads. This waiver will be rescinded when adequate time has been allowed to convert.

8-10. Capabilities of Non-CVRS and G-12D Cargo Parachute Loads

When non-CVRS loads or loads using the G-12D cargo parachutes are used, the following decreases in capabilities occur.

a. The G-12E cargo parachute was developed to lower the drop altitude. Using the G-12D cargo parachute increases the drop altitude by 100 feet. This will increase the exposure time of both the load and aircraft.

b. The CVRS was designed to restrain the load vertically during the aircraft flight. When the load is not restrained to CVRS standards, it must be vertically restrained for flight. These restraints will be removed up to 30 minutes before airdrop. After the restraints are removed, the aircraft will have reduced maneuverability for threat avoidance. Table 8-1 states the limitations that will occur if non-CVRS loads are used.

Table 8-1. Capability reduction of non-CVRS loads

Item	Limitations
<p>Corner skid board ties</p>	<p>Corner skid board ties were designed to secure the skid board to the load. When used, an additional vertical restraint must be installed inside the aircraft.</p>
<p>Steel strapping</p>	<p>Steel strapping located below the second layer of honeycomb or contacting the skid board makes the load non-CVRS compatible. The CVRS must be removed from the aircraft and vertical restraints must be used.</p>
<p>53 1/2- by 48-inch skid board (CVRS installed)</p>	<p>When dropped with the CVRS, the 48-inch sides become the front and rear. A single or double stick may be dropped. The load must be vertically restrained. Reduced capabilities of number of containers that can be dropped are C-130 aircraft--1 to 14 may be dropped; C-141 aircraft--1 to 36 may be dropped.</p> <p>Note: If containers have an overhang, the number will be reduced.</p>
<p>53 1/2- by 48-inch skid board (CVRS removed)</p>	<p>When the CVRS is removed, the 53 1/2-inch sides remain the front and rear. The load can be dropped in either a double or single stick, but double sticks must have an even number of containers. The load must be vertically restrained. The aircraft capabilities are C-130--1 to 16 containers; C-141--1 to 36 containers.</p>
<p>53 1/2- by 96-inch skid board</p>	<p>This container is not CVRS-compatible. The system must be removed. Vertical restraints must be installed. The 53 1/2-inch sides are the front and rear.</p>

CHAPTER 9 RIGGING TYPICAL A-22 LOADS

Section I RIGGING A-22 LOADS FOR LOW-VELOCITY AIRDROP

9-1. Description of Load

A typical load is rigged for low-velocity airdrop using an A-22 cargo bag. Typical loads include rations, repair parts, water cans, and other small items. Items to be dropped may be rigged in their original shipping containers or may be repacked for airdrop. A-22 container loads must weigh at least 501 pounds but not exceed 2,200 pounds, excluding the weight of the parachute. The load is rigged with one G-12E cargo parachute with a 68-inch diameter pilot parachute. See Chapter 2 for aircraft capabilities and limitations.

9-2. Preparing Drop Items

Prepare the drop items according to the load's sensitivity. Items must be well padded to prevent damage during airdrop. Items must also be padded or containerized to prevent them from falling out of the container during airdrop.

9-3. Preparing Skid Board

Prepare a locally fabricated skid board as shown in Figure 9-1.

Note: Precut skid boards ordered by National Stock Number DO NOT require the preparation shown in Figure 9-1.

- Notes:** 1. This drawing is not drawn to scale.
 2. All dimensions are given in inches.
 3. Use only AC grade plywood for skid board.

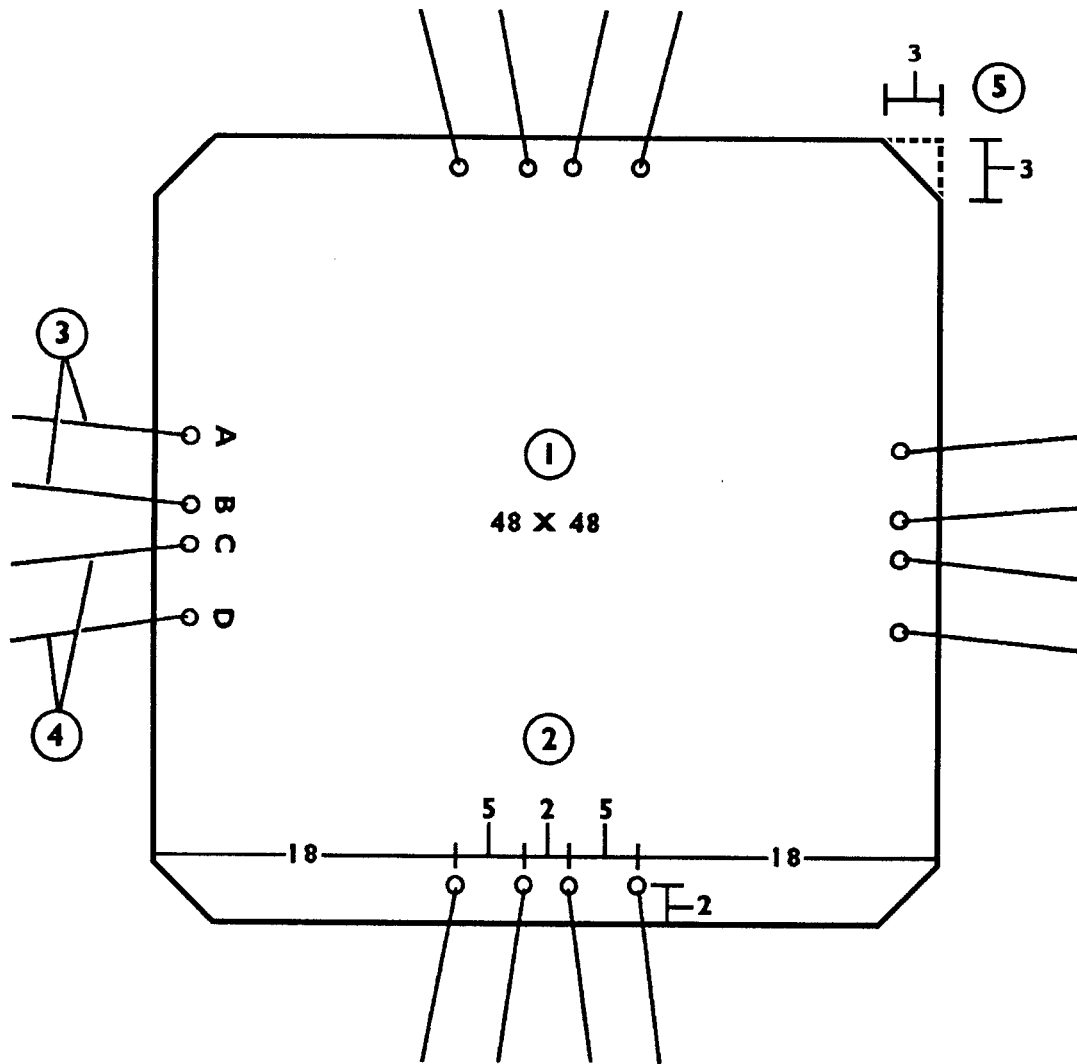

- ① Place a 3/4- or 1- by 48- by 48-inch piece of plywood on a flat surface.
- ② Drill four 1/2-inch holes on each side as shown above.
- ③ Cut eight 8-foot lengths of 1/2-inch tubular nylon webbing. Route one length through hole A from the bottom and the other end through hole B from the bottom. Even the ends.
- ④ Repeat step 3 for holes C and D and remaining sides.
- ⑤ Measure 3 inches in from each corner of the skid board and make a cut diagonally.

Figure 9-1. Locally fabricated skid board prepared for single A-22 load

9-4. Positioning Honeycomb

Position honeycomb as shown in Figure 9-2. Glue the pieces of honeycomb together; however, the stack does not have to be glued to the skid board.

CAUTION
The honeycomb must be 2 inches from all sides to allow proper operation of the CVRS.

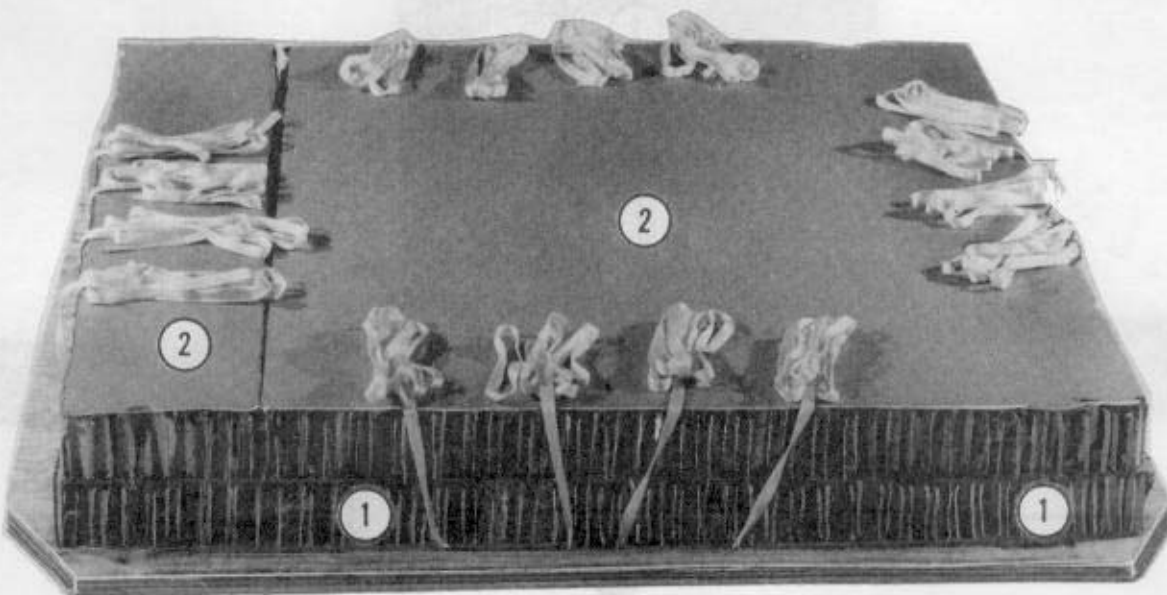

- ① Center a 36- by 44-inch and an 8- by 44-inch piece of honeycomb side by side on the skid board.
- ② Repeat step 1 for a second layer of honeycomb; however, alternate the pieces of honeycomb.

Figure 9-2. Honeycomb positioned on skid board

9-5. Positioning A-22 Cargo Bag Sling, Cover, and Load

Position the A-22 cargo bag sling, cover, and load as shown in Figure 9-3.

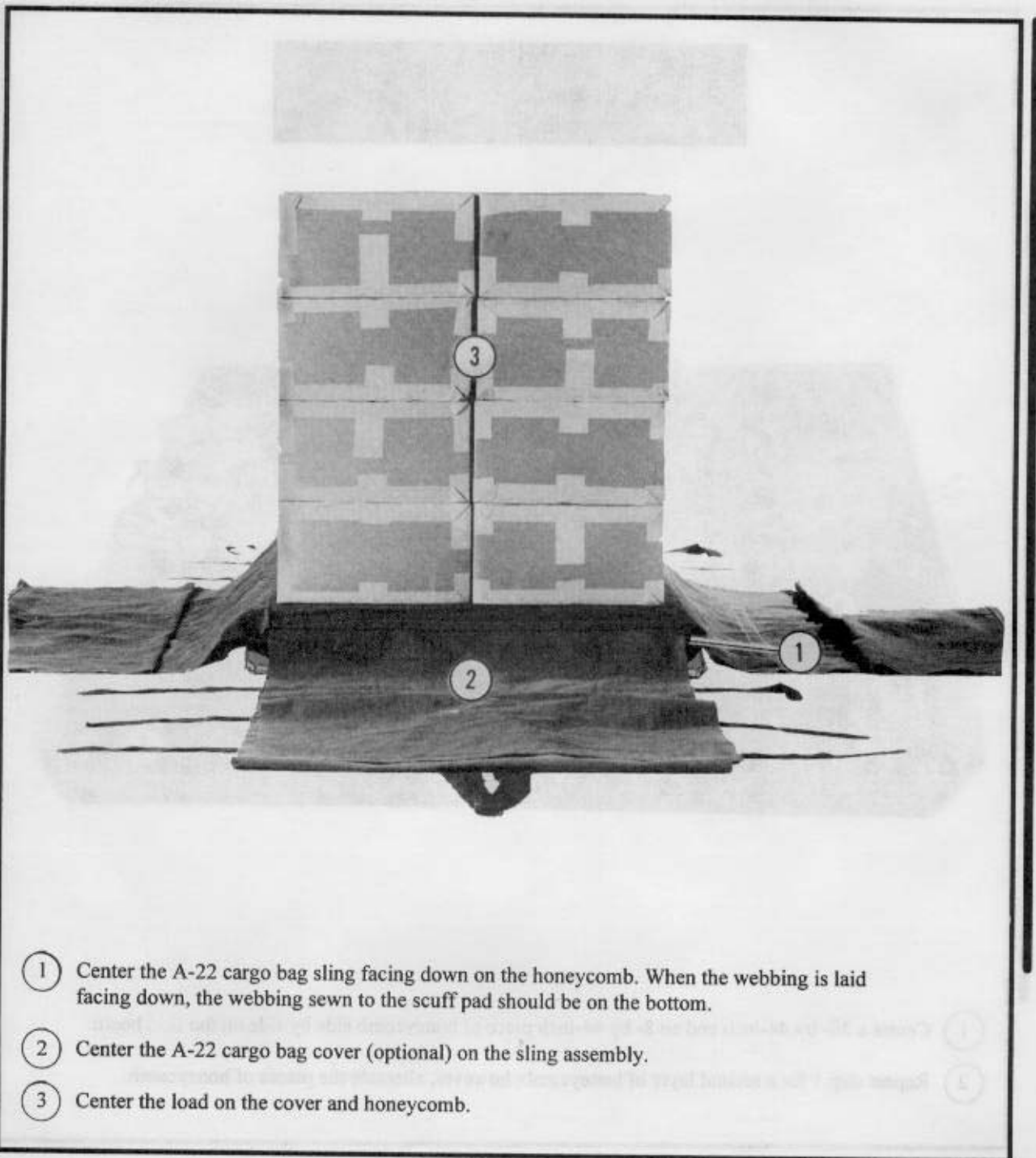
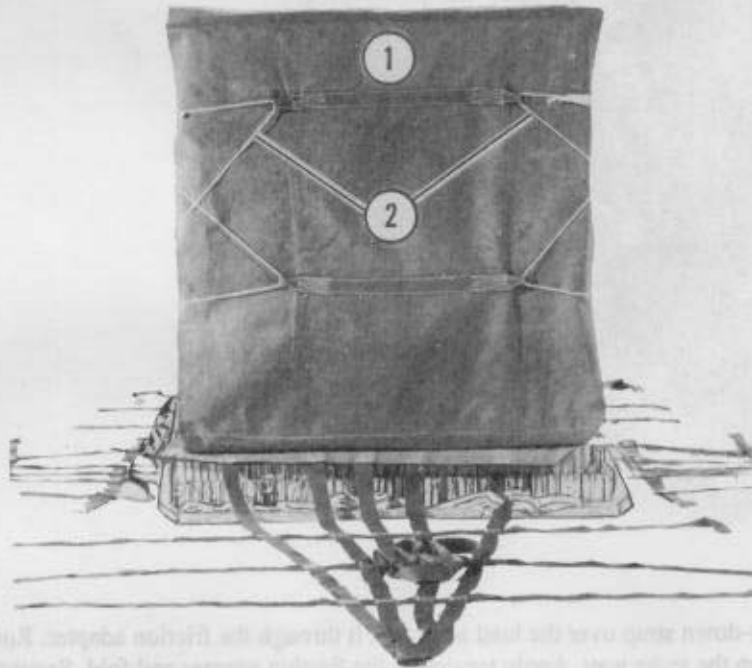
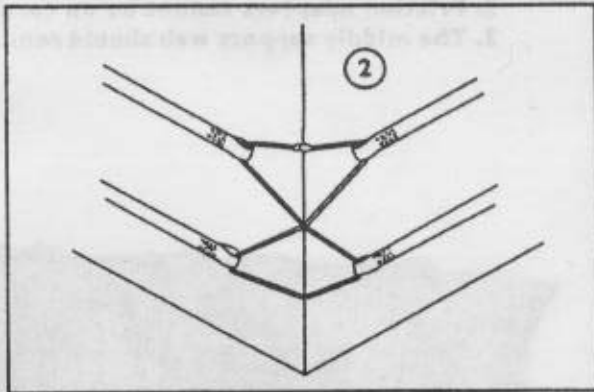
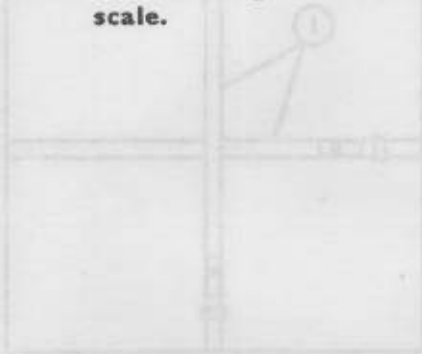

Figure 9-3. A-22 cargo bag sling, cover, and load positioned

9-6. Securing A-22 Cargo Bag Cover

Secure the A-22 cargo bag cover over the load as shown in Figure 9-4.

Note: This drawing is not drawn to scale.



- ① Bring up sides to cover the load. Fold under any side that will obstruct the bag cover securing ties.
- ② Using a length of type III nylon cord, route the cord as shown. Pull it tight and make a surgeon's knot and bow knot. Secure the knot and excess with masking tape. Make sure one running end is exposed.

Figure 9-4. A-22 cargo bag cover secured

9-7. Securing A-22 Cargo Bag Sling

Secure the sling assembly according to Figure 9-5.

- Notes:**
1. This drawing is not drawn to scale.
 2. Friction adapters cannot be on corners.
 3. The middle support web should remain vertical.

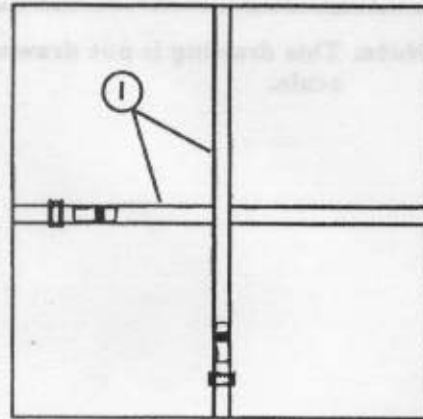

- 1 Bring the short tie-down strap over the load and route it through the friction adapter. Route the long tie-down strap the same way. Apply tension to the friction adapter and fold. Secure the excess as shown in Figure 1-3.
- 2 Route the two lower lateral straps through the friction adapters. Apply uniform tension, and secure the excess as shown in Figure 1-3.
- 3 If the top lateral strap is higher than the load, tighten the strap loosely on top of the load as shown above. If the load is higher than the lateral strap, place the strap over the corner and tighten it. If the strap cannot be placed over the corner, fasten the strap around the load sides. Pass a length of type I, 1/4-inch cotton webbing through each rectangle portion of the suspension web D-rings and tie the ends together with a surgeon's knot and locking knot.

Figure 9-5. A-22 cargo bag sling secured

9-8. Securing Skid Board to A-22 Cargo Bag

Secure the skid board to the A-22 cargo bag as shown in Figure 9-6. When tightening straps, make sure excess tension is not applied causing the sewn portion at the

intersection of lateral straps and support web to separate.

CAUTION
Skid board ties must be tight.

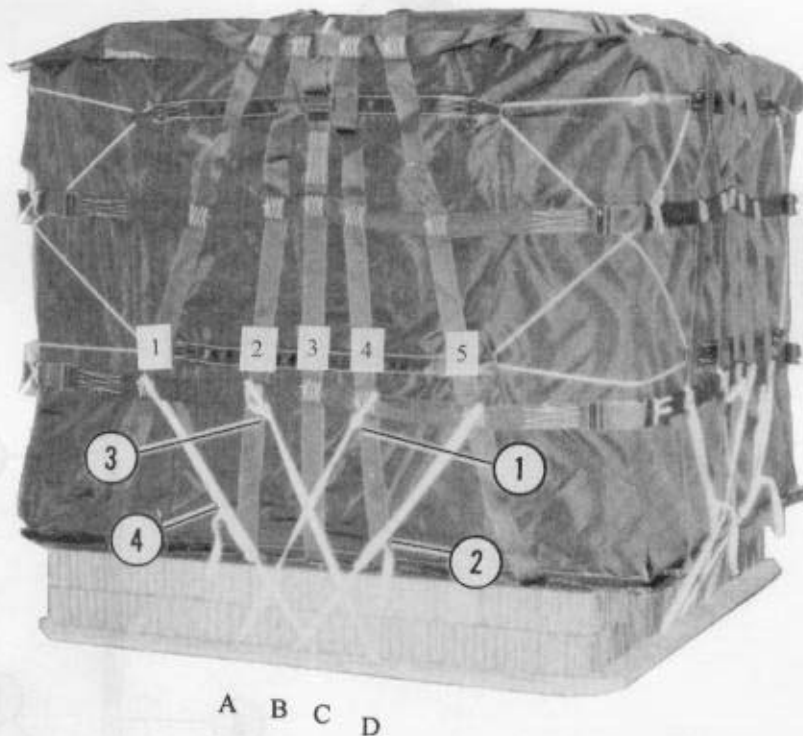

- 1 Starting at the left side, take tie-down A and diagonally tie it around the intersection of the lower lateral strap and fourth support web. Use three half-hitch knots and an overhand knot in the running end.
- 2 Route tie-down B around the fifth support web and lower lateral strap intersection diagonally. Pull the excess slack out, and tie it with trucker's hitch knot and an overhand knot in the running end. Cut excess webbing, leaving end approximately 6 inches long.
- 3 Repeat step 1 for tie-down D, and secure it to the second intersection on the lower lateral strap.
- 4 Repeat step 2 for tie-down C, and secure it to the first intersection on the lower lateral strap.
- 5 Repeat steps 1 through 4 for the other tie-downs (not shown).

Figure 9-6. Skid board secured to A-22 cargo bag

9-9. Attaching Suspension Webs

Attach four suspension webs as shown in Figure 9-7.

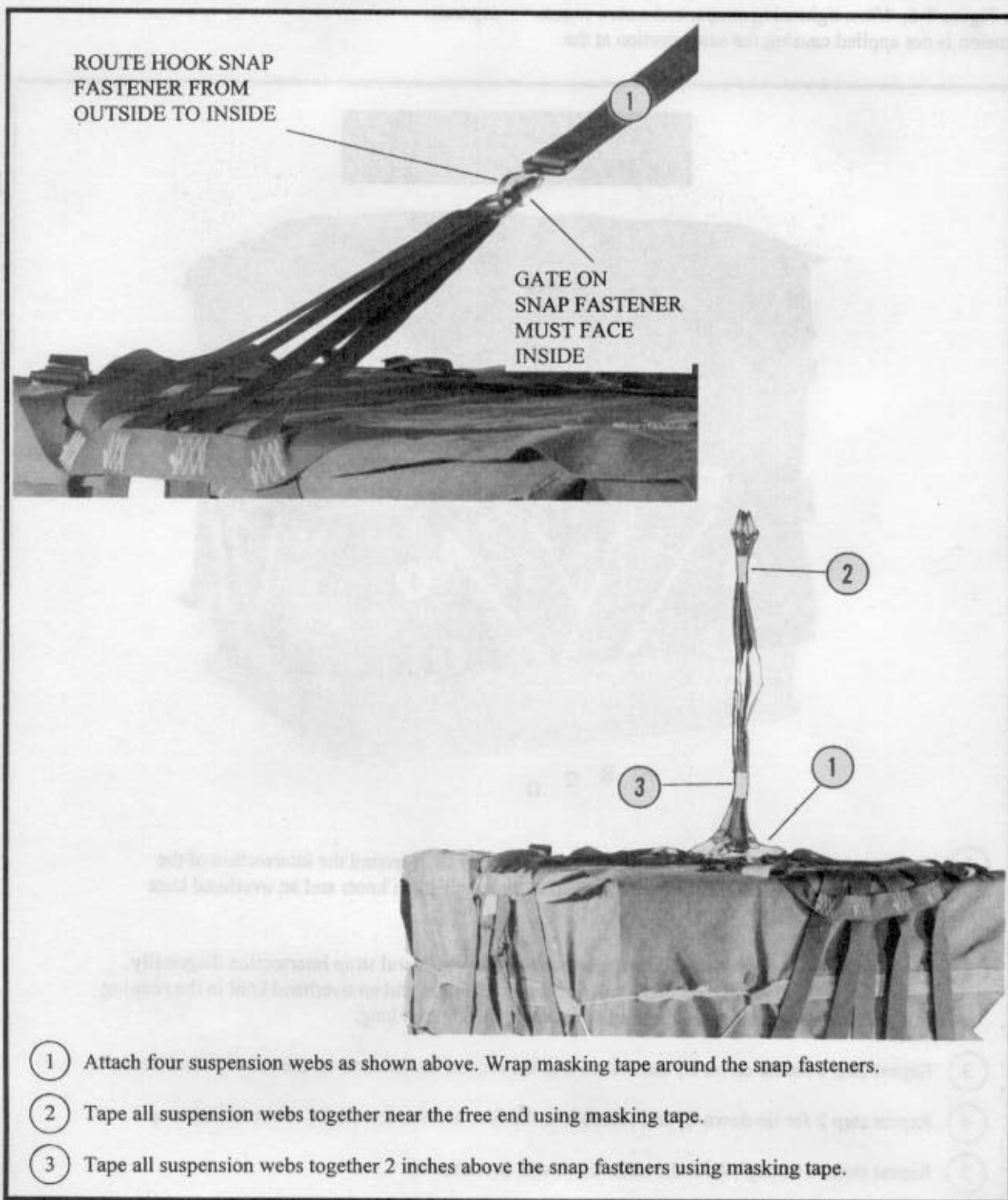

Figure 9-7. Suspension webs attached

9-10. Installing Parachute

Install the G-12E cargo parachute according to Chapter 8.

9-12. Equipment Required

Use the equipment listed in Table 9-1 to rig the load shown in Figure 9-8.

9-11. Marking Rigged Load

Mark the rigged load according to Chapter 1. Compute the rigged load data.

CAUTION

Make the final inspection required by Chapter 1 before the load leaves the rigging site. If the load includes hazardous material as defined in AFJMAN 24-204/TM 38-250, complete Shipper's Declaration for Dangerous Goods form.

**RIGGED LOAD DATA**

Weight (without parachute)	501 - 2,200 pounds
Parachute	G-12E

Figure 9-8. A-22 container load rigged with CVRS for low-velocity airdrop

Table 9-1. Equipment required for rigging an A-22 container load with CVRS for low-velocity airdrop

National Stock Number	Item	Quantity
8040-00-273-8713	Adhesive, paste, 1-gal	As required
1670-00-587-3421	Bag, cargo, A-22	1
4030-00-678-8562	Clevis, suspension, 3/4-in (medium)	1
4020-00-240-2146	Cord, nylon, type III, 550-lb	As required
1670-00-753-3928	Pad, energy-dissipating, honeycomb, 3- by 36- by 96-in: 8- by 44-in 36- by 44-in	2 sheets (2) (2)
1670-01-065-3755	Parachute, cargo, G-12E	1
5530-00-128-4981	Plywood, 3/4- by 48- by 96-in (locally fabricated skid board) <u>or</u>	1 sheet
5530-00-914-5118	Plywood, 1- by 48- by 48-in	1 sheet
7510-00-266-6710	Tape, masking, 2-in	As required
8310-01-102-4478	Thread, cotton, ticket number 8/7	As required
	Webbing:	
8305-00-268-2411	Cotton, 1/4-in, type I	As required
8305-00-082-5752	Nylon, tubular, 1/2-in	As required

Section II

RIGGING A-22 LOADS FOR HIGH-VELOCITY AIRDROP

9-13. Description of Load

A typical load is rigged for high-velocity airdrop using the A-22 cargo bag. Typical loads include rations, repair parts, water cans, and other small items. Items may be dropped in their original package or repacked for greater protection. See Chapter 2 for aircraft capabilities and limitations.

together; however, the stack does not have to be glued to the skid board. See Figure 9-9 for loads weighing less than 1,100 pounds. See Figure 9-10 for loads weighing more than 1,100 pounds.

Note: The maximum width of the top three layers of honeycomb is 48 inches.

9-14. Preparing Items and Skid Board

Refer to Paragraph 9-2 to prepare the items. Use 1-inch thick plywood to prepare a skid board according to Paragraph 9-3.

9-16. Rigging Container

Rig the container according to Paragraphs 9-5 through 9-9.

9-15. Positioning Honeycomb

Use Table 9-2 to determine the number and size of honeycomb layers. Honeycomb layers should be glued

9-17. Installing Parachute

Installing the 26-foot, high-velocity parachute according to Chapter 8.

Table 9-2. Honeycomb sizes for high-velocity A-22 loads

Weight of Load (Pounds)	Layer Number	Pieces	Length (Inches)	Width (Inches)	
501 - 1,100	1	1	44	36	
		1	44	8	
	2	3	44	8	
		1	48	36	
	3	1	48	12	
		3	48	8	
	4	1	48	36	
		1	48	12	
	1,100 - 2,200	1	1	44	36
			1	44	8
2		1	44	36	
		1	44	8	
3		1	48	36	
		1	48	12	
4		1	48	36	
		1	48	12	
5		1	48	36	
		1	48	12	

Note: On loads weighing 1,000 to 1,100 pounds, either stack formation may be used.

CAUTION

Loads over 1,300 pounds will not have full energy absorption on impact.

Note: This drawing is not drawn to scale.

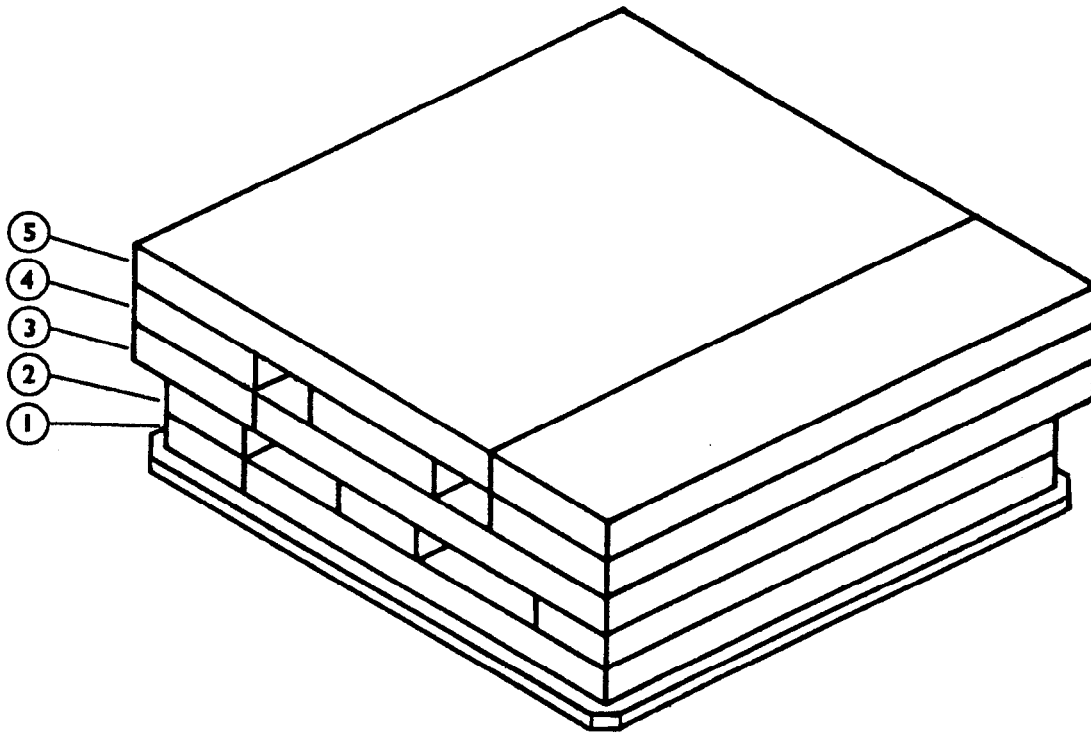

- ① Center a 36- by 44-inch and an 8- by 44-inch piece of honeycomb side by side on the skid board. Make sure the layer is 2 inches in from all sides.
- ② Cut three 8- by 44-inch pieces of honeycomb. Center one piece on top of the first layer of honeycomb. Place one piece of honeycomb even with each side edge.
- ③ Center a 36- by 48-inch and a 12- by 48-inch piece of honeycomb side by side on top of the second layer of honeycomb.
- ④ Cut three 12- by 48-inch pieces of honeycomb. Center one piece on top of the third layer of honeycomb. Place one piece of honeycomb even with each side edge.
- ⑤ Repeat step 3 for the fifth layer of honeycomb.

Figure 9-9. Honeycomb positioned for load weighing less than 1,100 pounds

Note: This drawing is not drawn to scale.

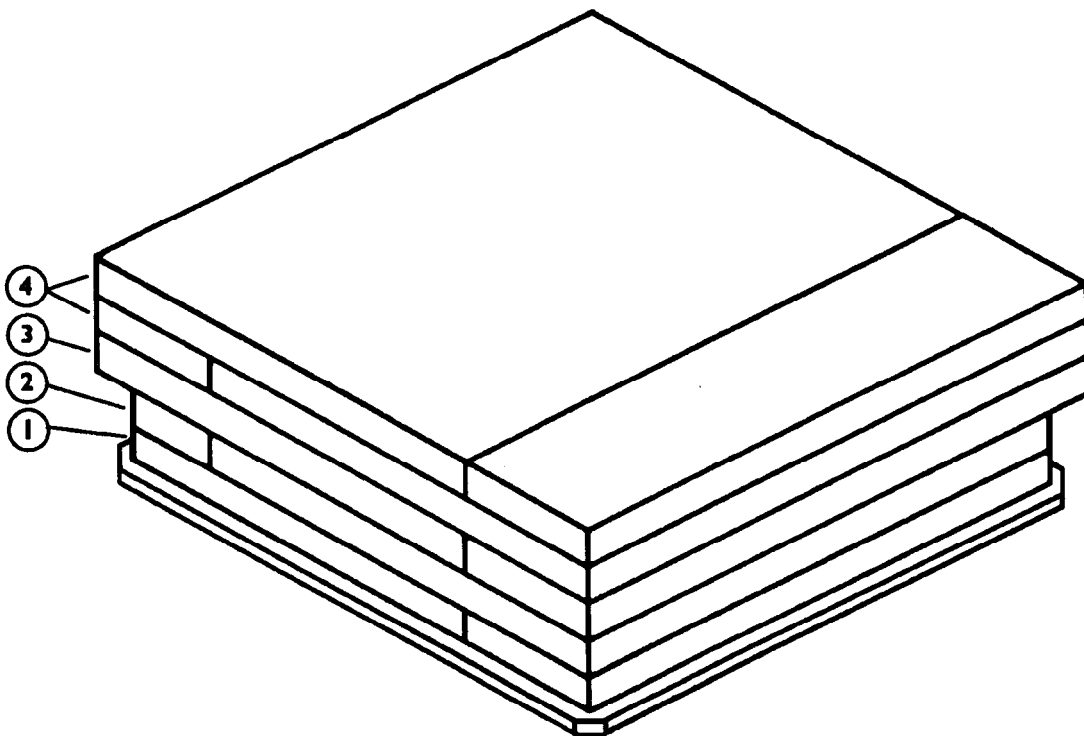

- ① Center a 36- by 44-inch and an 8- by 44-inch piece of honeycomb side by side on the skid board. Make sure the layer is 2 inches in from all sides.
- ② Repeat step 1 and alternate the pieces of honeycomb for the second layer of honeycomb.
- ③ Center a 36- by 48-inch and a 12- by 48-inch piece of honeycomb side by side on top of the second layer of honeycomb.
- ④ Repeat step 3 and alternate the pieces of honeycomb for the fourth and fifth layers of honeycomb.

Figure 9-10. Honeycomb positioned for load weighing more than 1,100 pounds

9-18. Marking Rigged Load

Mark the rigged load according to Chapter 1. Compute the rigged load data.

9-19. Equipment Required

Use the equipment listed in Table 9-3 to rig the load shown in Figure 9-11.



Figure 9-11. A-22 container load weighing less than 1,100 pounds rigged with CVRS for high-velocity airdrop

Table 9-3. Equipment required for rigging an A-22 container load weighing less than 1,100 pounds with CVRS for high-velocity airdrop

National Stock Number	Item	Quantity
8040-00-273-8713	Adhesive, paste, 1-gal	As required
1670-00-587-3421	Bag, cargo, A-22	1
4030-00-678-8562	Clevis, suspension, 3/4-in (medium)	1
4020-00-240-2146	Cord, nylon, type III, 550-lb	As required
1670-00-753-3928	Pad, energy-dissipating, honeycomb,	
	3- by 36- by 96-in:	3 sheets
	8- by 44-in	(9)
	12- by 48-in	(5)
	36- by 44-in	(3)
	36- by 48-in	(2)
1670-00-872-6109	Parachute, cargo, high-velocity, 26-ft	1
5530-00-128-4981	Plywood, 3/4- by 48- by 96-in	
	(locally fabricated skid board)	1 sheet
	or	
5530-00-914-5118	Plywood, 1- by 48- by 48-in	1 sheet
8305-00-074-5124	Tape, adhesive, 2-in	As required
8310-01-102-4478	Thread, cotton, ticket number 8/7	As required
	Webbing:	
8305-00-268-2411	Cotton, 1/4-in, type I	As required
8305-00-082-5752	Nylon, tubular, 1/2-in	As required

Section III

RIGGING DOUBLE A-22 CARGO BAG LOADS FOR LOW-VELOCITY AIRDROP

9-20. Description of Load

A typical load is rigged for low-velocity airdrop using a double A-22 container. The double container is made by using two A-22 cargo bags. The cover is optional. The weight limitation of the load is 900 to 2,200 pounds, excluding the weight of the parachute. The

load is rigged with one G-12E cargo parachute with a 68-inch diameter pilot parachute. See Chapter 2 for aircraft capabilities and limitations.

9-21. Preparing Skid Board

Prepare a skid board as shown in Figure 9-12.

- Notes:**
1. This drawing is not drawn to scale.
 2. All dimensions are given in inches.
 3. Use only AC grade plywood for skid board.

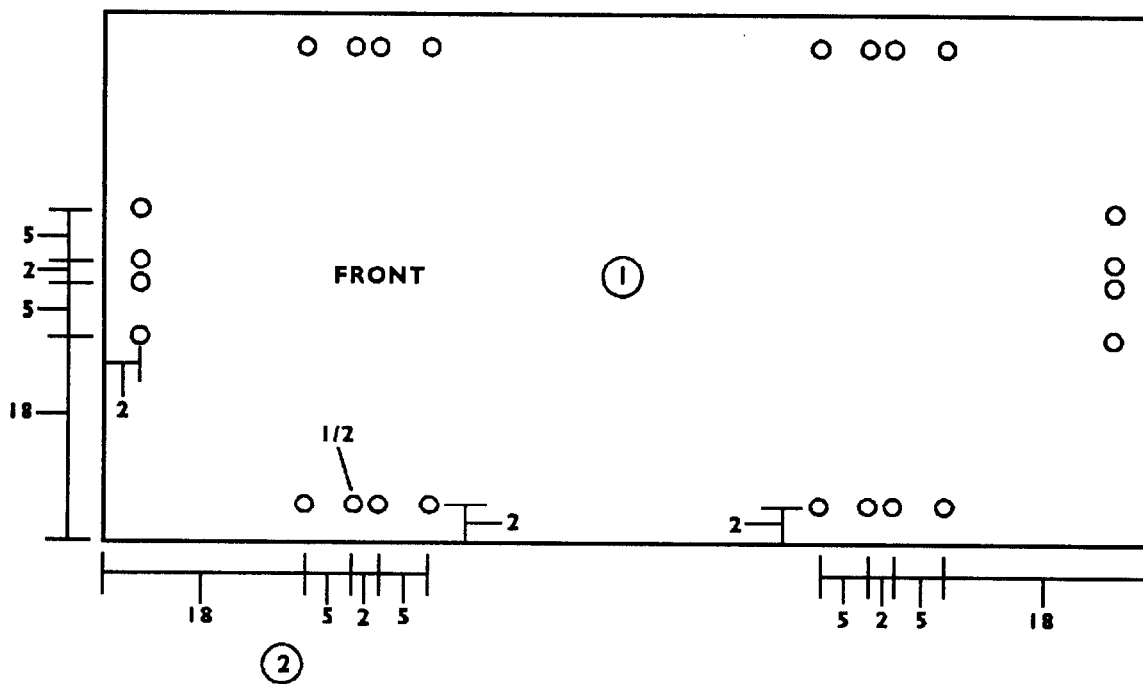

- ① Place a 3/4- or 1- by 48- by 96-inch sheet of plywood on a flat surface.
- ② Drill twenty-four 1/2-inch holes as shown above.

Figure 9-12. Skid board prepared for double A-22 load

9-22. Prepare Skid Board Ties and Positioning Honeycomb

Prepare the skid board ties and position the honeycomb on the skid board as shown in Figure 9-13.

Note: This drawing is not drawn to scale.

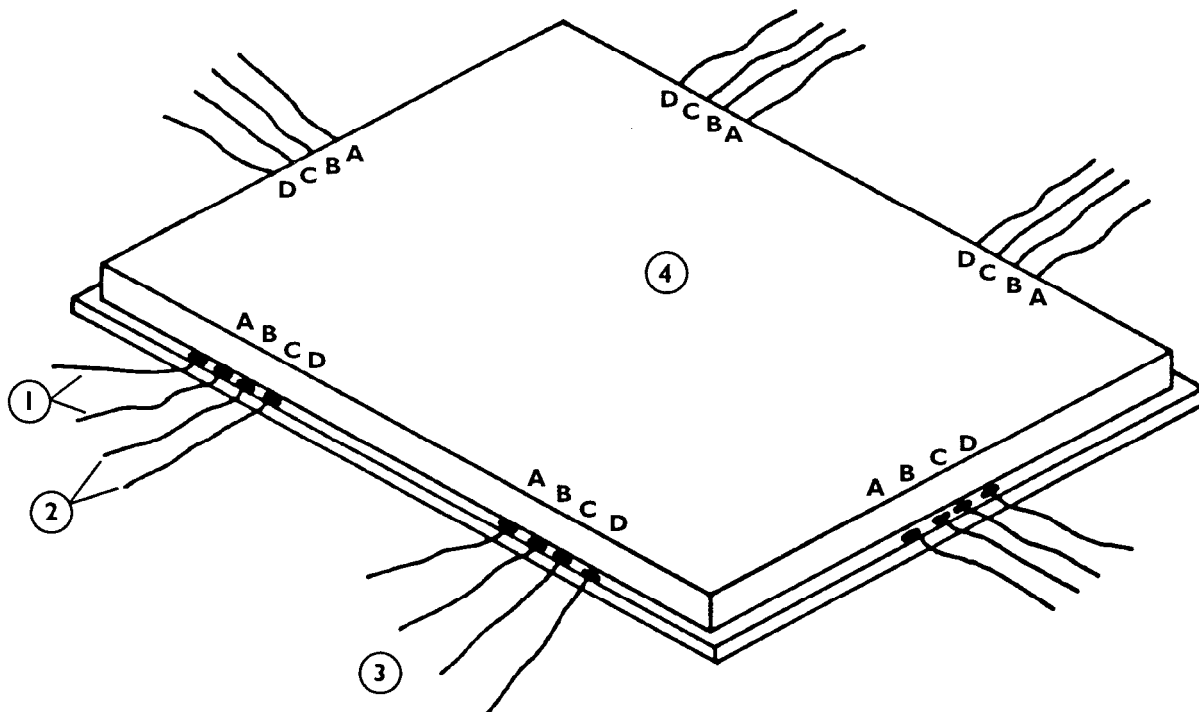

- ① Cut twelve 8-foot lengths of 1/2-inch tubular nylon webbing. Route one end through hole A and the other through hole B, from bottom to top.
- ② Repeat step 1 for holes C and D.
- ③ Repeats steps 1 and 2 for the other five sets of holes.
- ④ Determine the size of honeycomb needed according to the size of the load. Cut and center the honeycomb on the skid board. Make sure the honeycomb is 2 inches in from all sides.

Figure 9-13. Skid board ties prepared and honeycomb positioned

9-23. Positioning A-22 Sling Assemblies

Position two A-22 sling assemblies on the double A-22 load as shown in Figure 9-14.

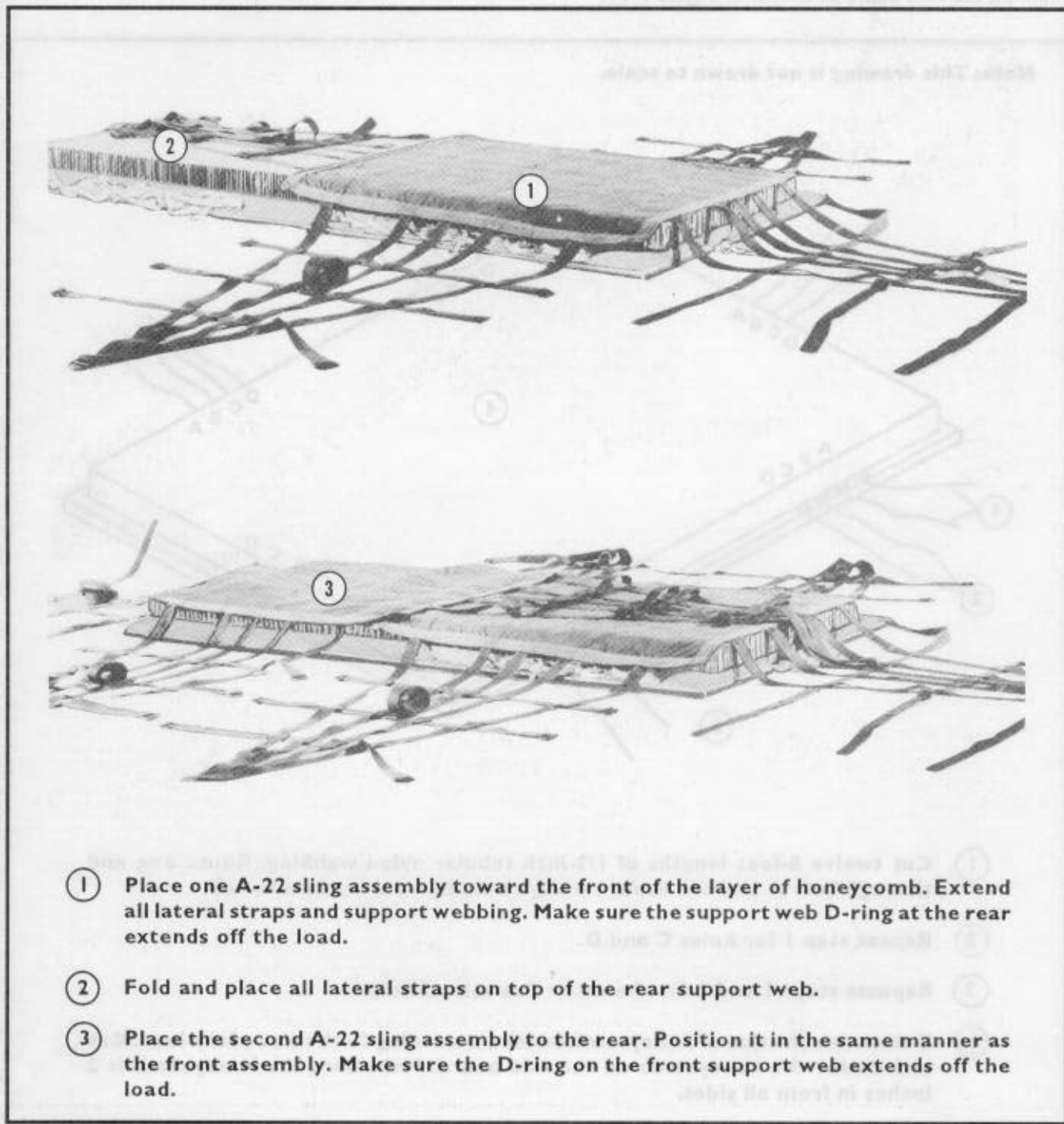

- ① Place one A-22 sling assembly toward the front of the layer of honeycomb. Extend all lateral straps and support webbing. Make sure the support web D-ring at the rear extends off the load.
- ② Fold and place all lateral straps on top of the rear support web.
- ③ Place the second A-22 sling assembly to the rear. Position it in the same manner as the front assembly. Make sure the D-ring on the front support web extends off the load.

Figure 9-14. A-22 sling assemblies positioned

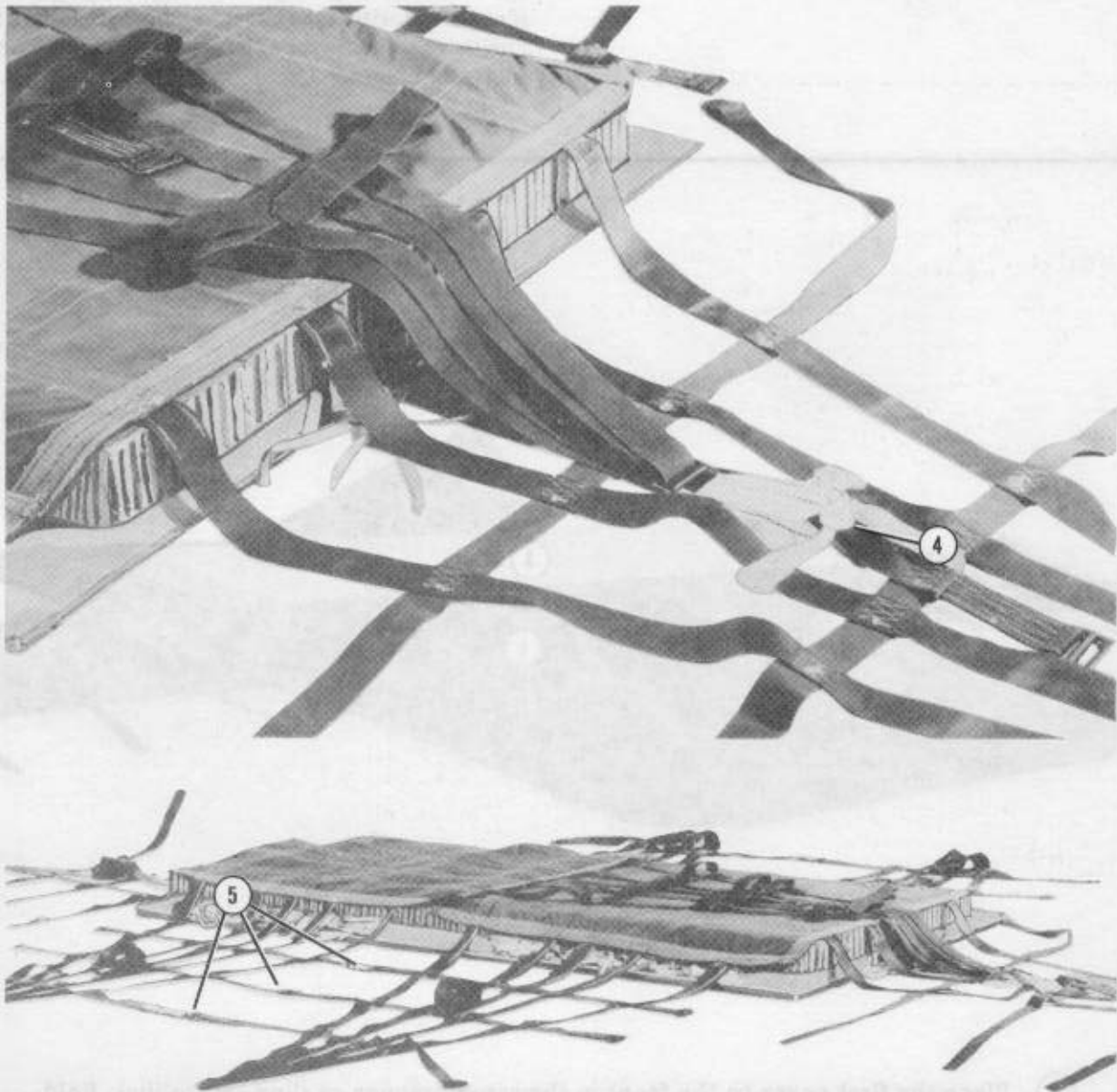

- ④ Use a length of type VIII nylon webbing to tie the support web D-rings exposed at the front and rear of the load to the other A-22 sling assembly as shown.
- ⑤ Cut six lengths of type VIII nylon webbing. Route one length through each set of friction adapters at the midsection of the load as shown. Do not apply tension at this time.

Figure 9-14. A-22 sling assemblies positioned (continued)

9-24. Positioning Covers and Honeycomb

Use two A-22 cargo bag covers when rigging this load, if needed. Position the covers as shown in Figure 9-15. Position another layer of honeycomb on the covers as shown in Figure 9-15.

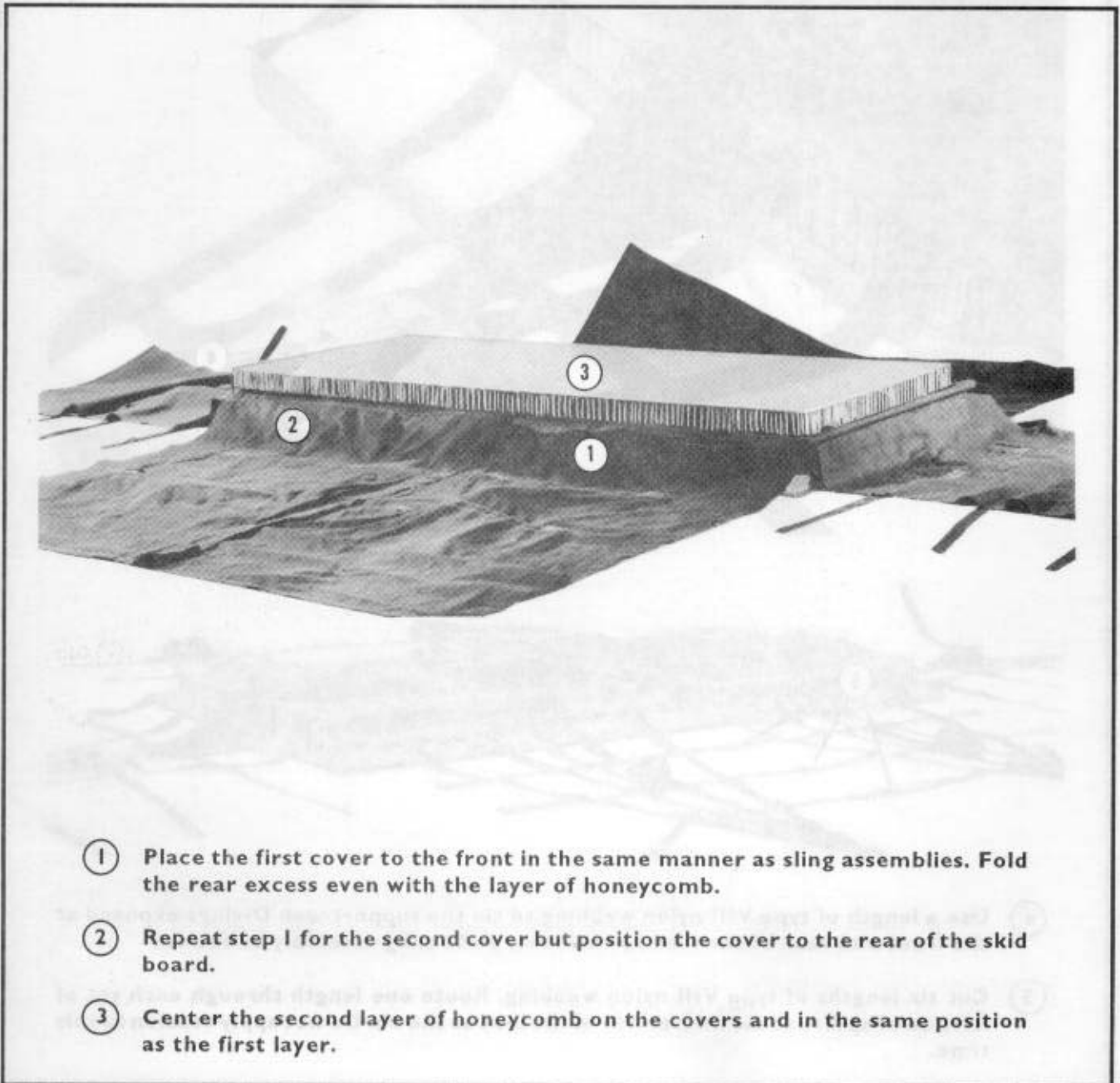

- ① Place the first cover to the front in the same manner as sling assemblies. Fold the rear excess even with the layer of honeycomb.
- ② Repeat step 1 for the second cover but position the cover to the rear of the skid board.
- ③ Center the second layer of honeycomb on the covers and in the same position as the first layer.

Figure 9-15. Covers and honeycomb positioned

9-25. Positioning Load and Closing Bag Covers

Center the load so that the weight of the load is evenly distributed. Use honeycomb and cellulose wadding to protect the items. Use cord, rope, or steel strapping to keep the load from shifting. Close the bag as shown in Figure 9-16.

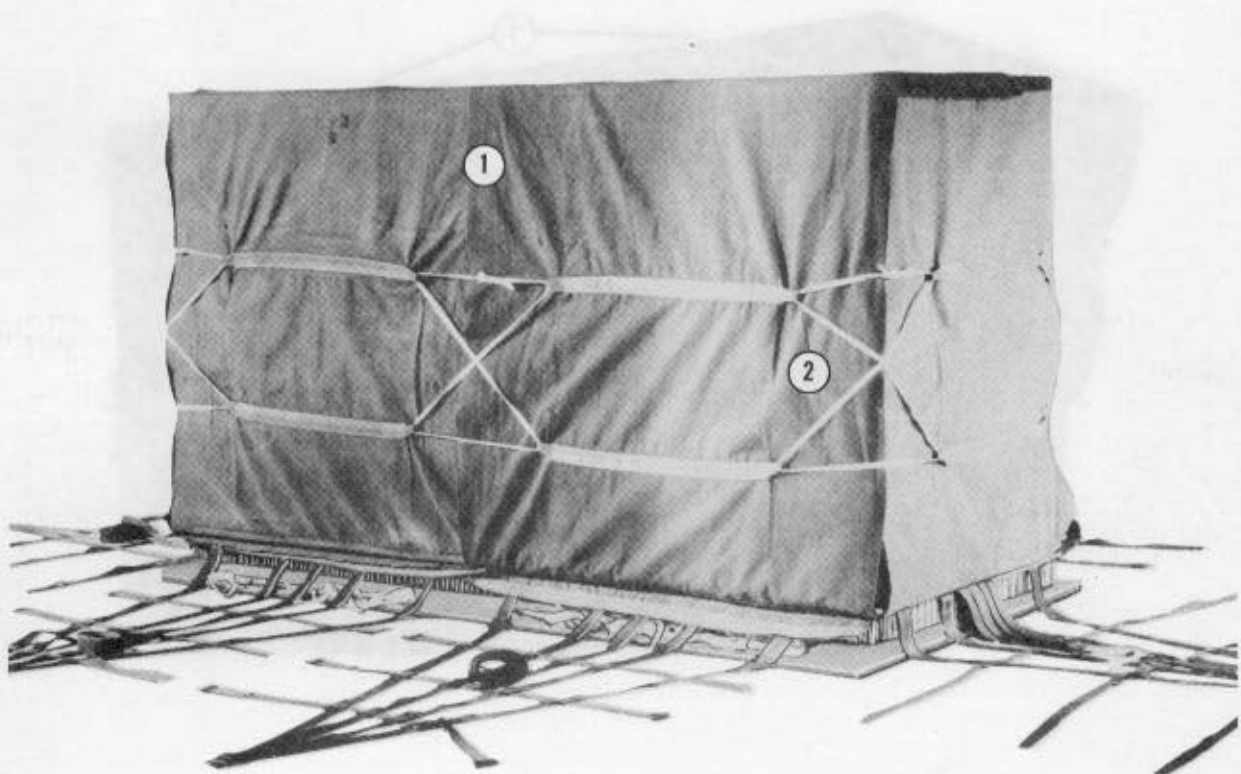

- ① Fold the bag covers over the front and rear first, then the sides over the top. Fold under the excess side covers.
- ② Use six lengths of 1/2-inch tubular nylon webbing to lace the bag closed. Pull the webbing tight and tie the running ends in a surgeon's knot and bow knot. Tape the excess and knot. Leave one running end slightly exposed to allow rapid derigging.

Figure 9-16. A-22 cargo bag covers closed

9-26. Securing Tie-Down Straps

Secure the tie-down straps as shown in Figure 9-17.

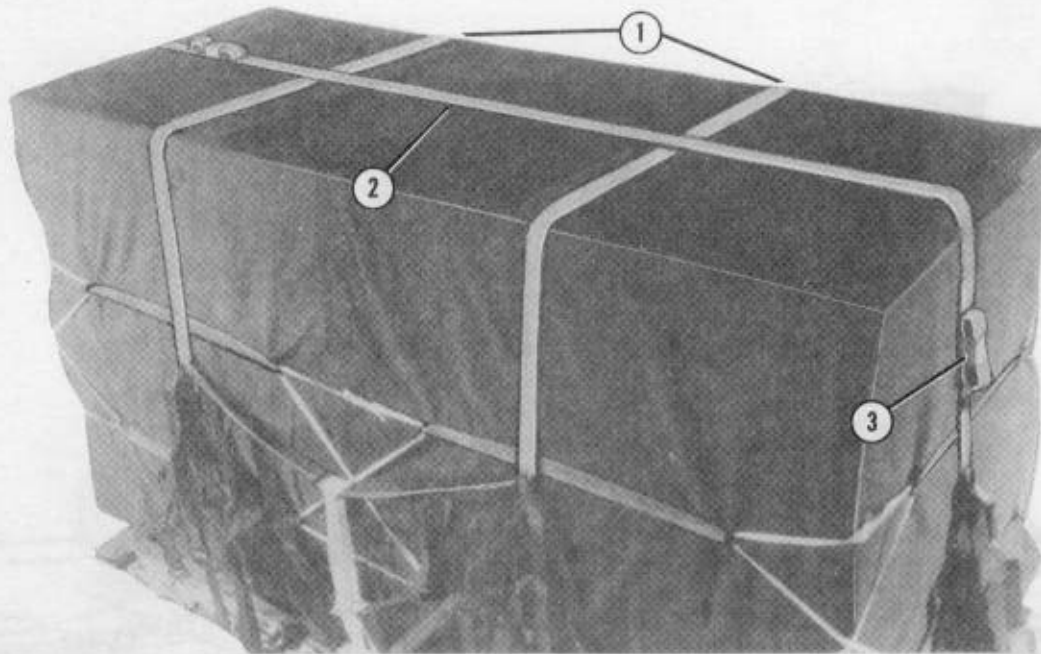

- ① Run the side tie-down straps through the friction adapters. Apply tension to the straps.
- ② If necessary, attach a 36- or 60-inch nylon webbing strap to either the front or rear tie-down strap. Route the running end through the friction adapter on the opposite end.
- ③ Fold the excess on the tie-down straps. Tape or tie it as shown in Figure 1-3.

Figure 9-17. Tie-down straps secured

9-27. Securing Lateral Straps

Secure the lateral straps as shown in Figure 9-18.

Note: If top lateral straps are on the top of the load, make sure they are tightened loosely.

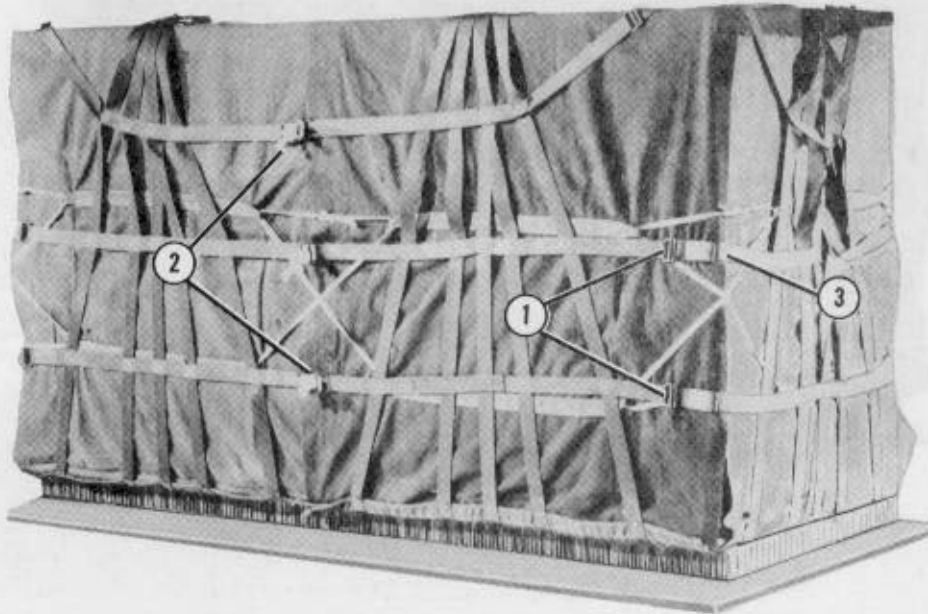

- ① Lay the remaining portions of the sling assemblies over the load. Route the lateral straps through the friction adapters.
- ② Tighten the center friction adapters and type VIII nylon webbing (Figure 9-13) so that the middle suspension web on each container is vertical. Install a knot in the running ends of the type VIII nylon webbing about 3 inches from the friction adapters.
- ③ Apply equal tension on the remaining lateral straps. Fold the excess and tape or tie it in place as shown in Figure 1-3.

Figure 9-18. Lateral straps secured

9-28. Securing Skid Board Ties

Secure the skid board ties as shown in Figure 9-19.

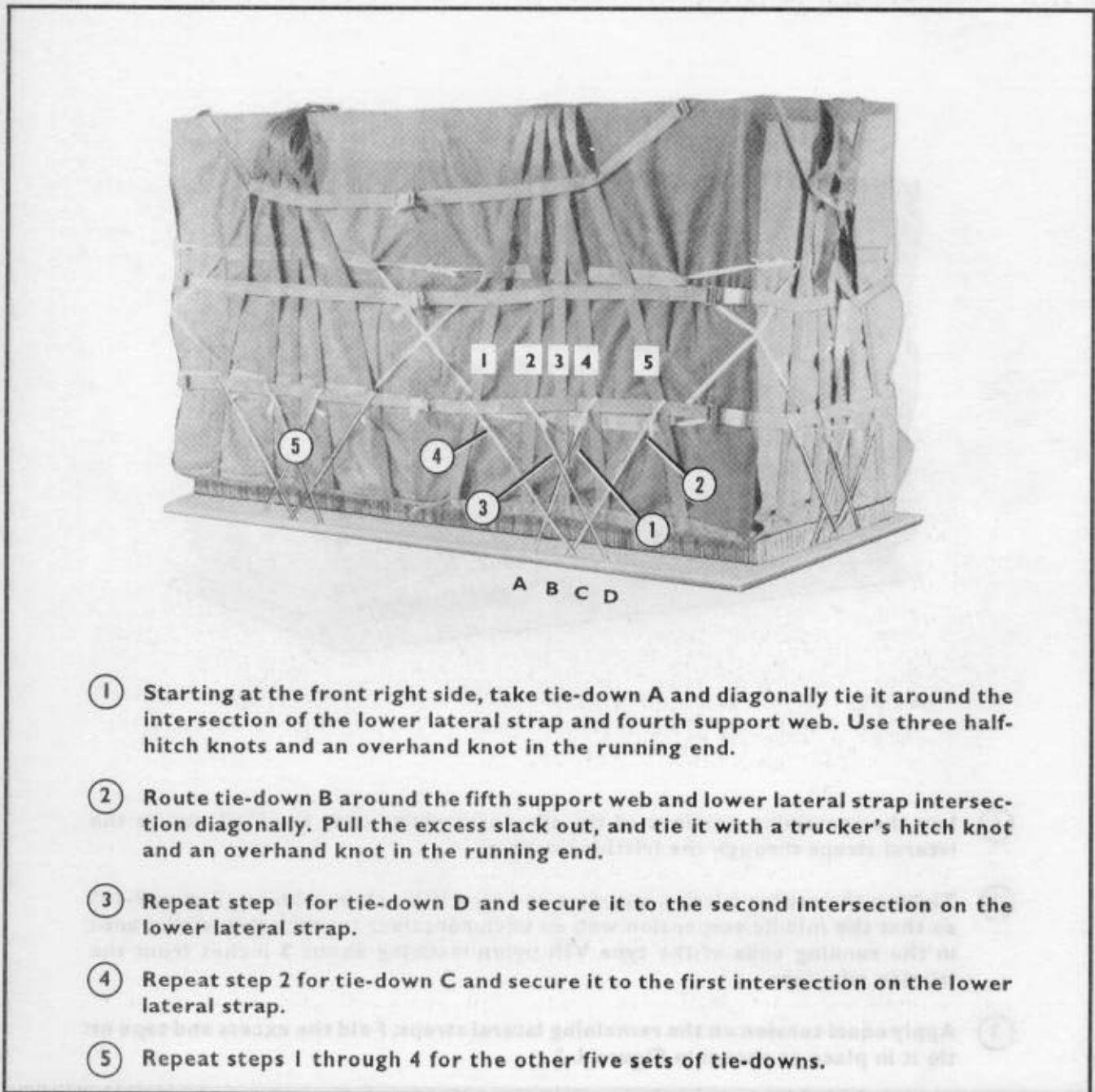
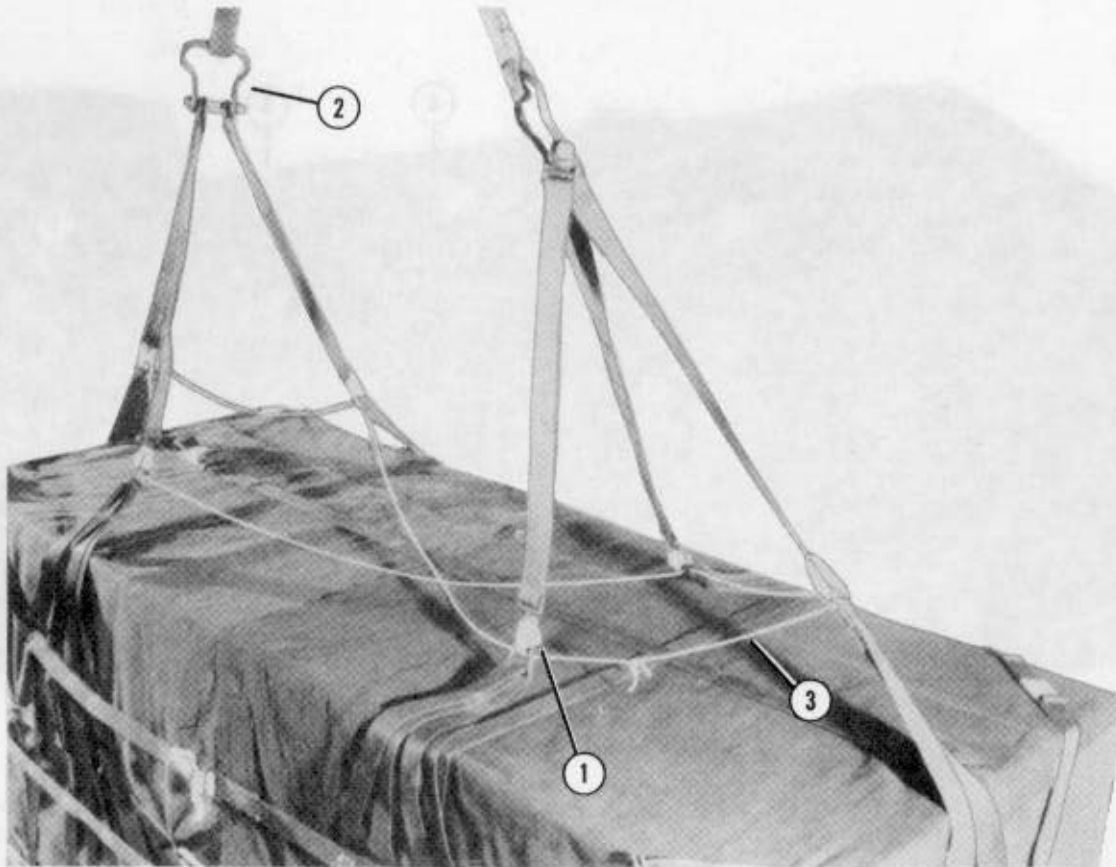

Figure 9-19. Skid board ties secured

9-29. Installing Suspension Slings

Install suspension slings using six suspension webs, two 3/4-inch cargo suspension clevises, and two 3-foot (2-loop), type XXVI nylon webbing slings as shown in Figure 9-20.



- ① Attach one suspension web to each of the six D-rings. Route the snap hook from outside to inside. Wrap each hook with masking tape.
- ② Place a 3-foot sling on each clevis. Bolt the three suspension webs at the front of the load to one clevis. Repeat step for the rear set.
- ③ Route a length of type III nylon cord through the six D-rings as shown above. Tie the ends together. Make sure the tie has excess to allow suspension sling movement.

Figure 9-20. Suspension slings installed

9-30. Installing Parachute

Install a G-12E cargo parachute as shown in Figure 9-21.

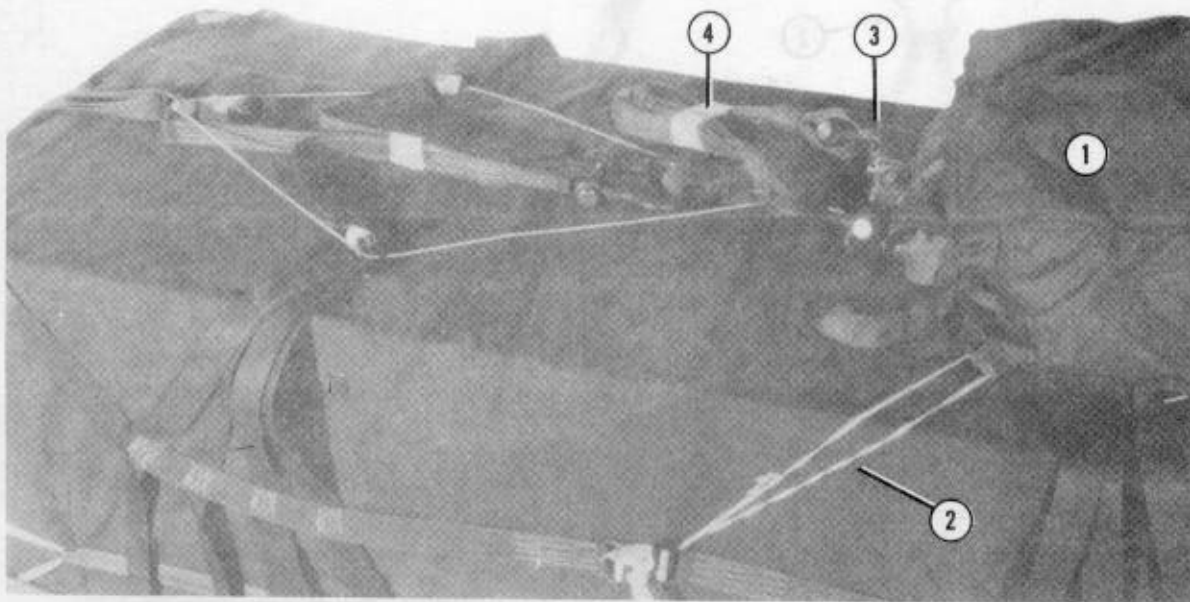

- ① Place a G-12E cargo parachute on the load with the riser compartment up and the bridle toward the front of the load. Position the parachute on the front of the load.
- ② Tie each corner of the parachute to the sling assembly using type I, 1/4-inch cotton webbing.
- ③ Bolt the two 3-foot slings to the parachute's cargo suspension clevis. Make sure the risers from the parachute are not removed from the clevis.
- ④ Fold and tape the excess sling with masking tape.

Figure 9-21. G-12E cargo parachute installed

9-31. Marking Rigged Load

Mark the rigged load according to Chapter 1. Compute the rigged load data.

9-32. Equipment Required

Use the equipment listed in Table 9-4 to rig the load shown in Figure 9-22.

CAUTION
 Make the final inspection required by Chapter 1 before the load leaves the rigging site. If the load includes hazardous material as defined in AFJMAN 24-204/TM 38-250, complete Shipper's Declaration for Dangerous Goods form.



RIGGED LOAD DATA	
Weight (without parachute)	900 - 2,200 pounds
Parachute	G-12E

Figure 9-22. Double A-22 cargo bag rigged for low-velocity airdrop

Table 9-4. Equipment required for rigging double A-22 cargo bag for low-velocity airdrop

National Stock Number	Item	Quantity
1670-00-587-3421	Bag, cargo, A-22	2
4030-00-678-8562	Clevis, suspension, 3/4-in (medium)	2
1670-00-753-3928	Pad, energy-dissipating, honeycomb, 3- by 36- by 96-in: 36- by 92-in	2 sheets (2)
	Parachute:	
1670-01-065-3755	Cargo, G-12E	1
1670-00-216-7297	Pilot, 68-in diam	1
5530-00-128-4981	Plywood, 3/4- by 48- by 96-in	1 sheet
	or	
No NSN	Plywood, 1- by 48- by 96-in	1 sheet
1670-01-062-6301	Sling, cargo, airdrop, 3-ft (2-loop), type XXVI nylon webbing	2
1670-00-368-7486	Strap, webbing, restraint (shear strap), 60-in	1
7510-00-266-6710	Tape, masking, 2-in	As required
	Webbing:	
8305-00-268-2411	Cotton, 1/4-in, type I	As required
	Nylon:	
8305-00-082-5752	Tubular, 1/2-in	As required
8305-00-263-3591	Type VIII	As required

Section IV
RIGGING STRETCH A-22 CARGO BAG LOADS FOR LOW-VELOCITY AIRDROP

9-33. Description of Load

A typical load is rigged for low-velocity airdrop using a stretch A-22 container. The stretch container is made by using two A-22 cargo bags. The cover is optional. The weight limitation of the load is 900 to 2,200 pounds, excluding the weight of the parachute. The

G-12E cargo parachute can be used. See Chapter 1 for aircraft capabilities and limitations.

9-34. Preparing Skid Board

Prepare a skid board as shown in Figure 9-23.

- Notes:**
1. This drawing is not drawn to scale.
 2. All dimensions are given in inches.
 3. Use only AC grade plywood for skid board.

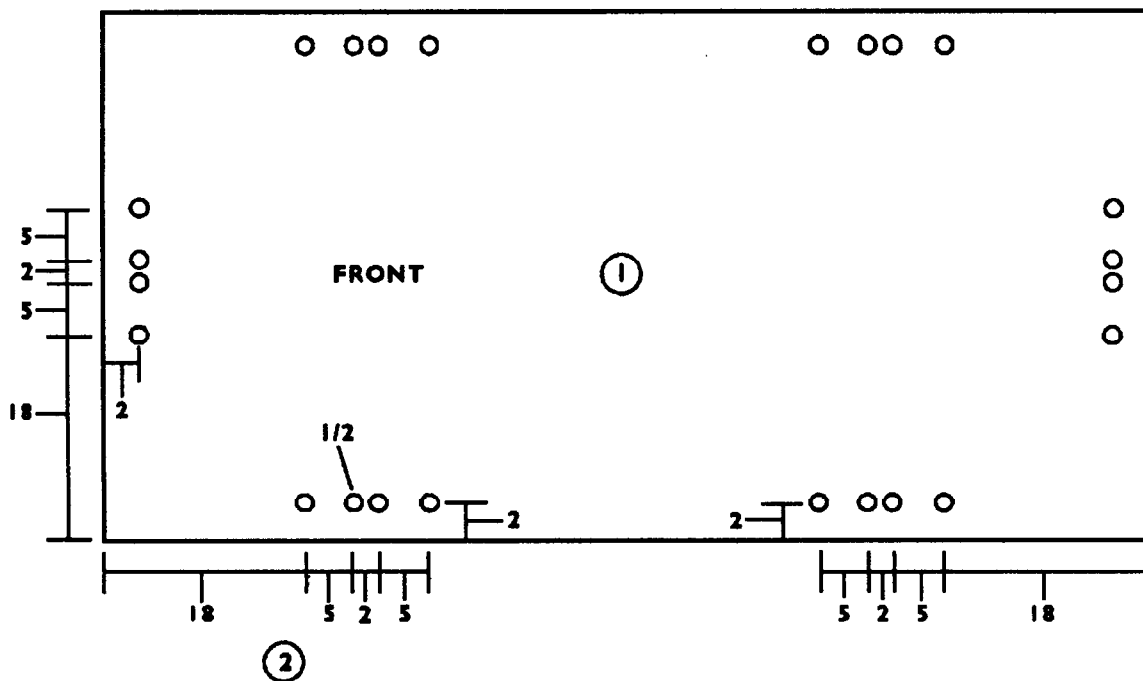

- ① Place a 3/4- or 1- by 48- by 72-inch sheet of plywood on a flat surface.
- ② Drill twenty-four 1/2-inch holes as shown above.

Figure 9-23. Skid board prepared for stretch A-22 load

9-35. Preparing Skid Board Ties and Positioning Honeycomb

Prepare the skid board ties and position the honeycomb on the skid board as shown in Figure 9-24.

Note: This drawing is not drawn to scale.

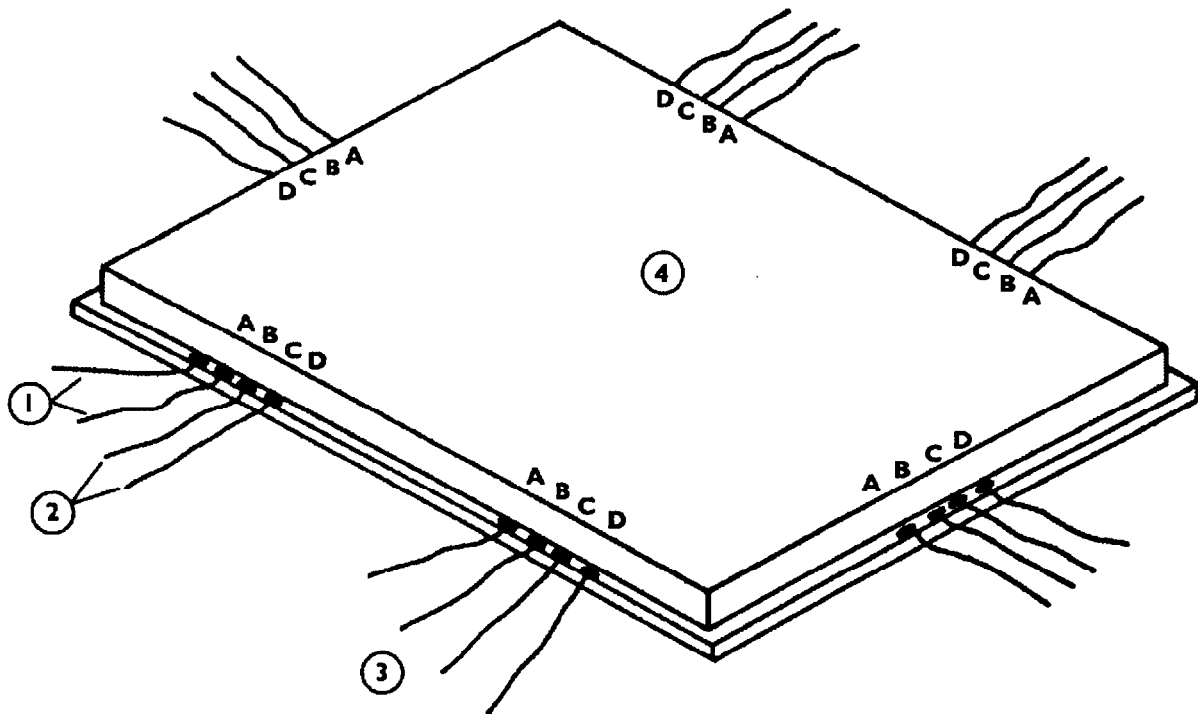

- ① Cut twelve 8-foot lengths of 1/2-inch tubular nylon webbing. Route one end through hole A and the other through hole B, from bottom to top.
- ② Repeat step 1 for holes C and D.
- ③ Repeat steps 1 and 2 for the other five sets of holes.
- ④ Determine the size of honeycomb needed according to the size of the load. Cut and center the honeycomb on the skid board. Make sure the honeycomb is 2 inches in from all sides.

Figure 9-24. Skid board ties prepared and honeycomb positioned

9-36. Positioning A-22 Sling Assemblies

Position two A-22 sling assemblies on the stretch A-22 load as shown in Figure 9-25.

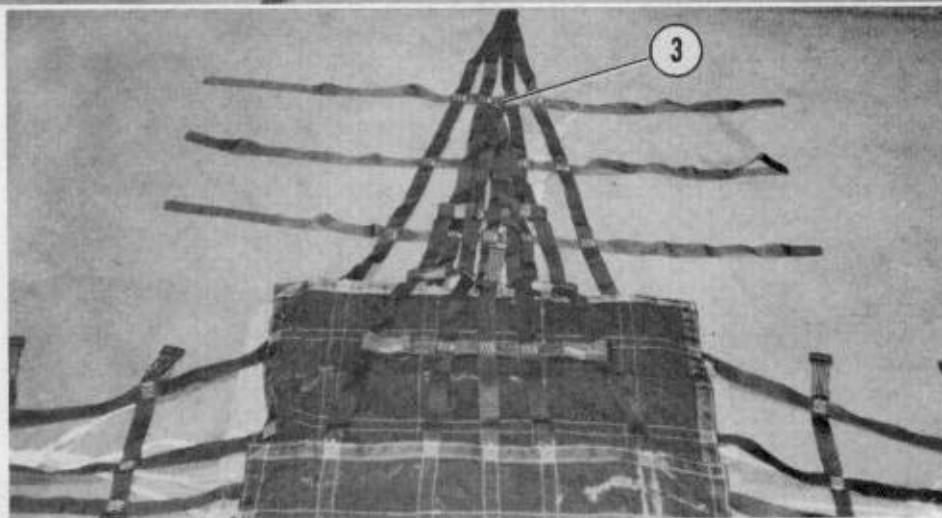
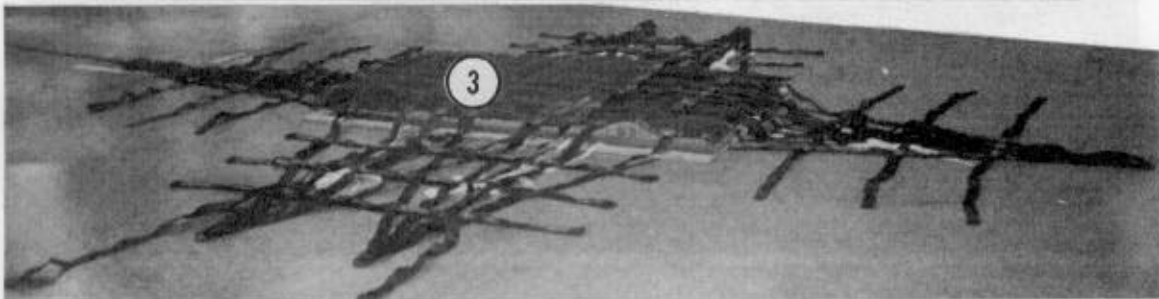
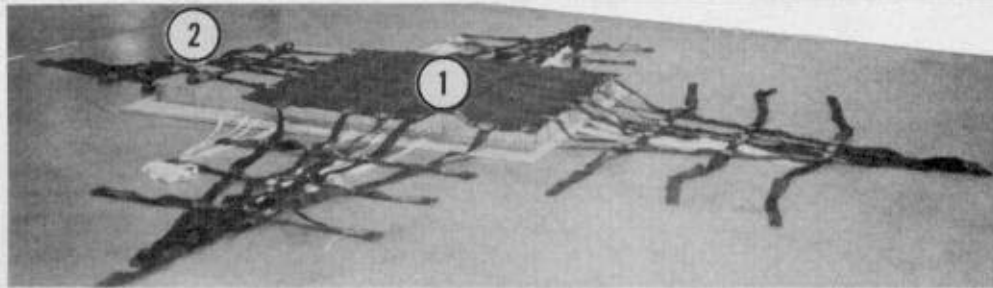

- 1 Place one A-22 sling assembly toward the front of the layer of honeycomb. Extend all lateral straps and support webbing. Make sure the support web D-ring at the rear extends off the load.
- 2 Fold and place all lateral straps on top of the rear support web.
- 3 Place the second A-22 sling assembly to the rear. Position it in the same manner as the front assembly. Make sure the D-ring on the front support web extends off the load and reaches the front top lateral strap of the other A-22 sling assembly as shown.

Figure 9-25. A-22 sling assemblies positioned

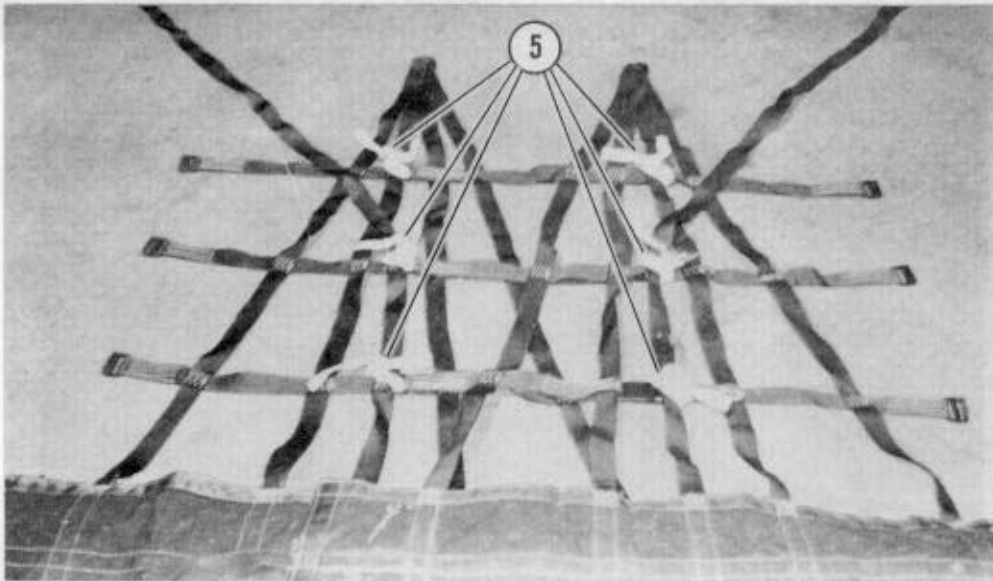
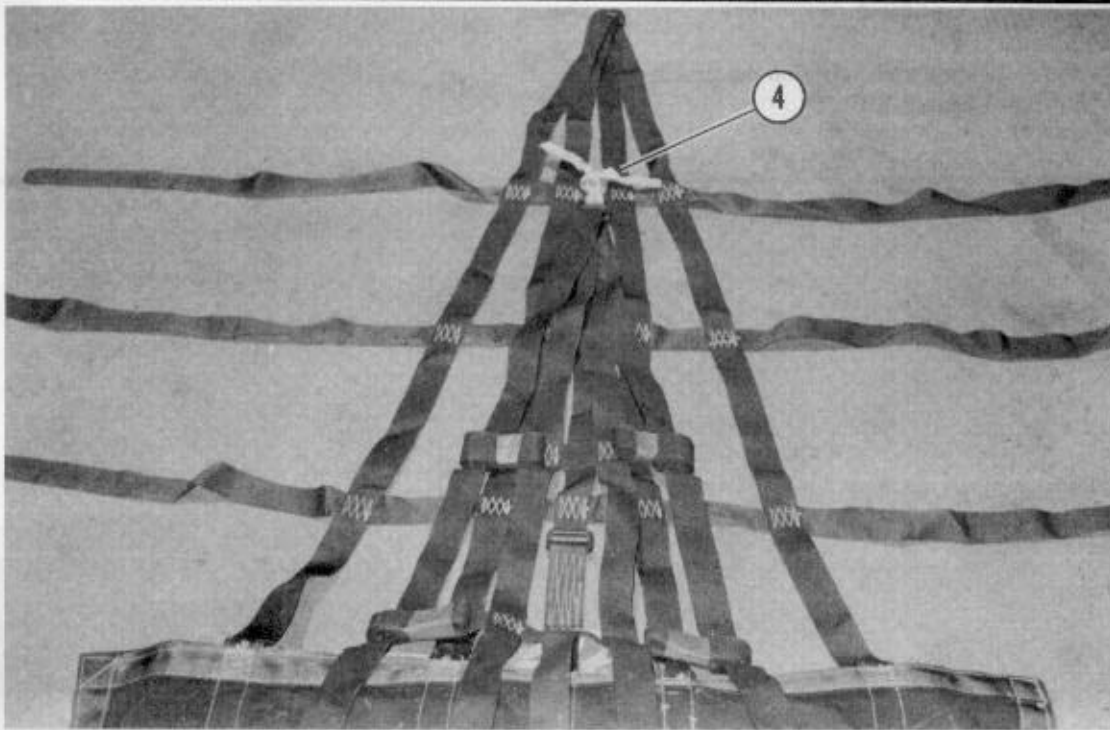

- 4 Use a length of type VIII nylon webbing or two turns of 1-inch tubular nylon webbing to tie the support web D-rings exposed at the front and rear of the load to the top lateral strap of the other A-22 sling assembly as shown.
- 5 Use a length of type VIII nylon webbing or two turns of 1-inch tubular nylon webbing to tie the friction adapters diagonally around the intersection of the short tie-down strap and the corresponding lateral strap of the other sling assembly as shown.

Figure 9-25. A-22 sling assemblies positioned (continued)

9-37. Positioning Covers and Honeycomb

Use two A-22 cargo bag covers when rigging this load, if needed. Position the covers as shown in Figure 9-26.

Position another layer of honeycomb on the covers as shown in Figure 9-26.

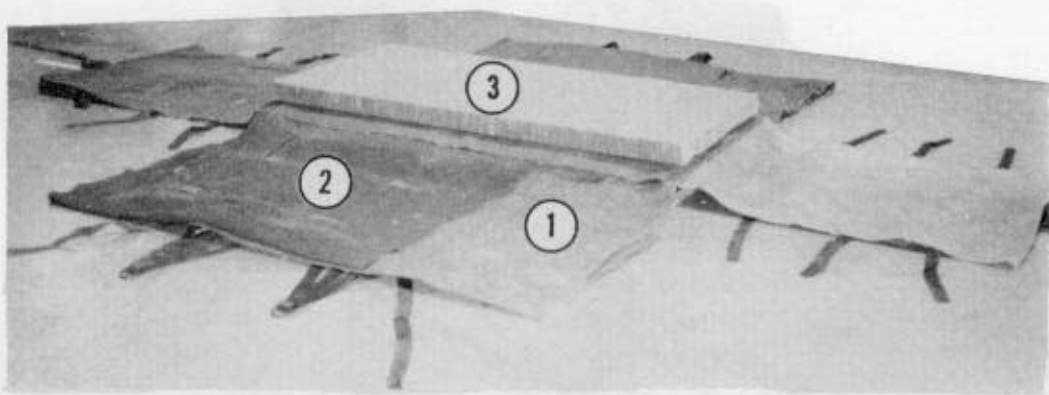

- ① Place the first cover to the front in the same manner as sling assemblies. Fold the rear excess even with the layer of honeycomb.
- ② Repeat step 1 for the second cover but position the cover to the rear of the skid board.
- ③ Center the second layer of honeycomb on the covers and in the same position as the first layer.

Figure 9-26. Covers and honeycomb positioned

9-38. Positioning Load and Closing Bag Covers

Center the load so that the weight of the load is evenly distributed. Use honeycomb and cellulose

wadding to protect the items. Use cord, rope, or steel strapping to keep the load from shifting. Close the bag as shown in Figure 9-27.

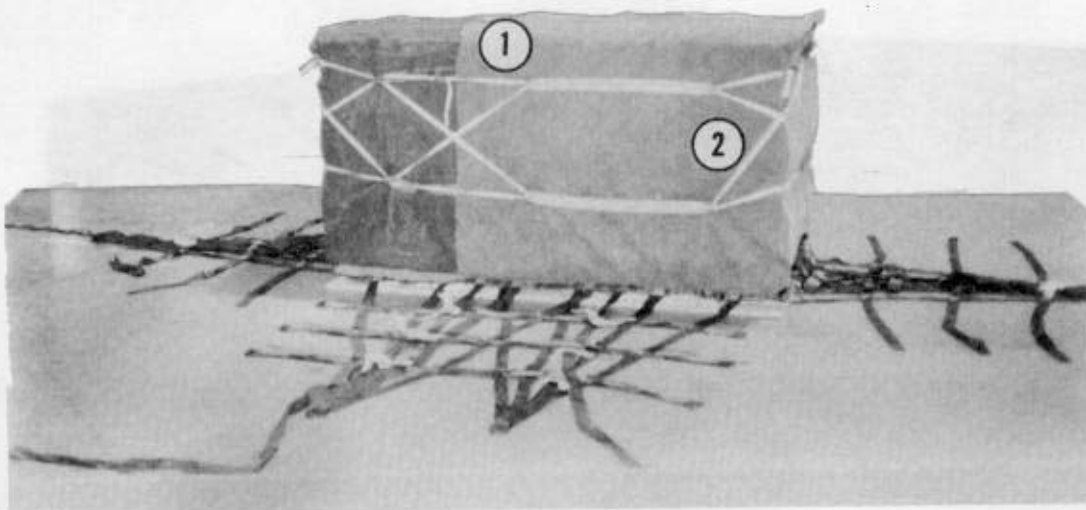

- ① Fold the bag covers over the front and rear first, then the sides over the top. Fold under the excess side covers.
- ② Use six lengths of 1/2-inch tubular nylon webbing to lace the bag closed. Pull the webbing tight and tie the running ends in a surgeon's knot and bow knot. Tape the excess and knot. Leave one running end slightly exposed to allow rapid derigging.

Figure 9-27. A-22 cargo bag covers closed

9-39. Securing Tie-Down Straps

Secure the tie-down straps as shown in Figure 9-28.

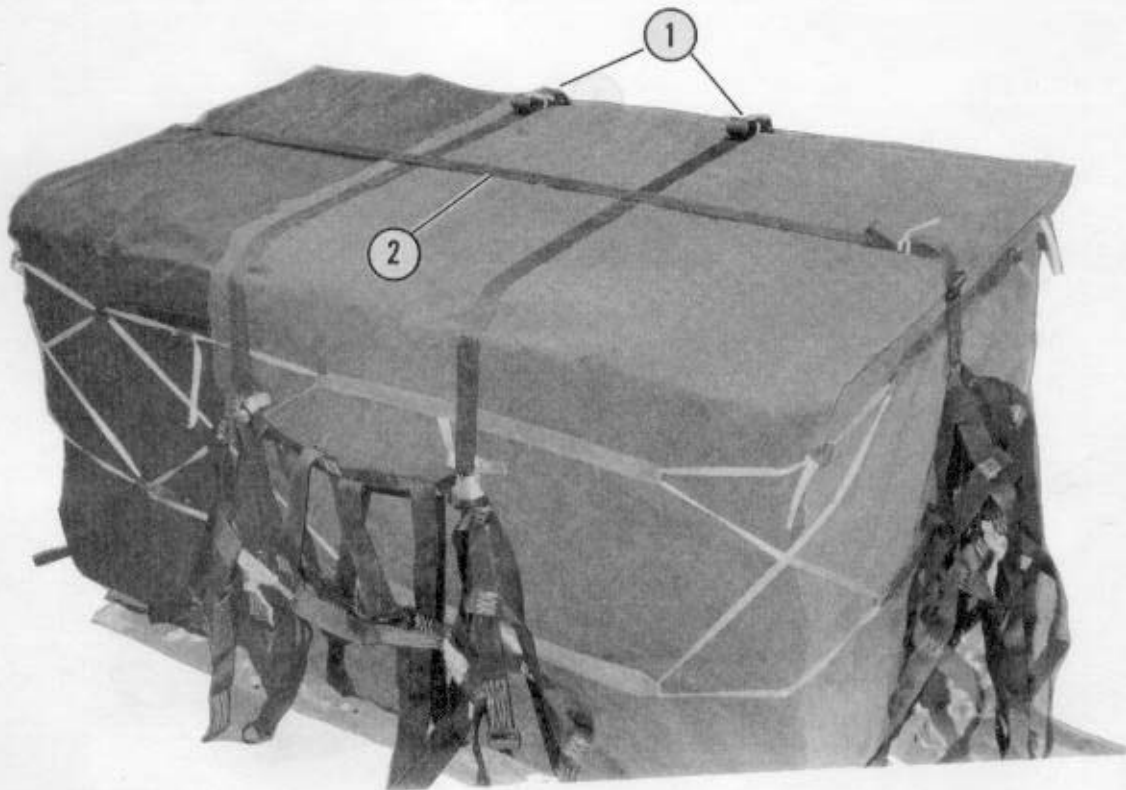

- ① Run the side short tie-down straps through the friction adapters. Apply tension to the straps.
- ② If necessary, attach a 60-inch nylon webbing strap to either the front or rear long tie-down strap. Route the running end through the friction adapter on the opposite end.
- ③ Fold the excess on the tie-down straps. Tape or tie it as shown in Figure 1-3.

Figure 9-28. Tie-down straps secured

9-40. Securing Lateral Straps

Secure the lateral straps as shown in Figure 9-29.

Note: If top lateral straps are on top of the load, make sure they are tightened loosely.

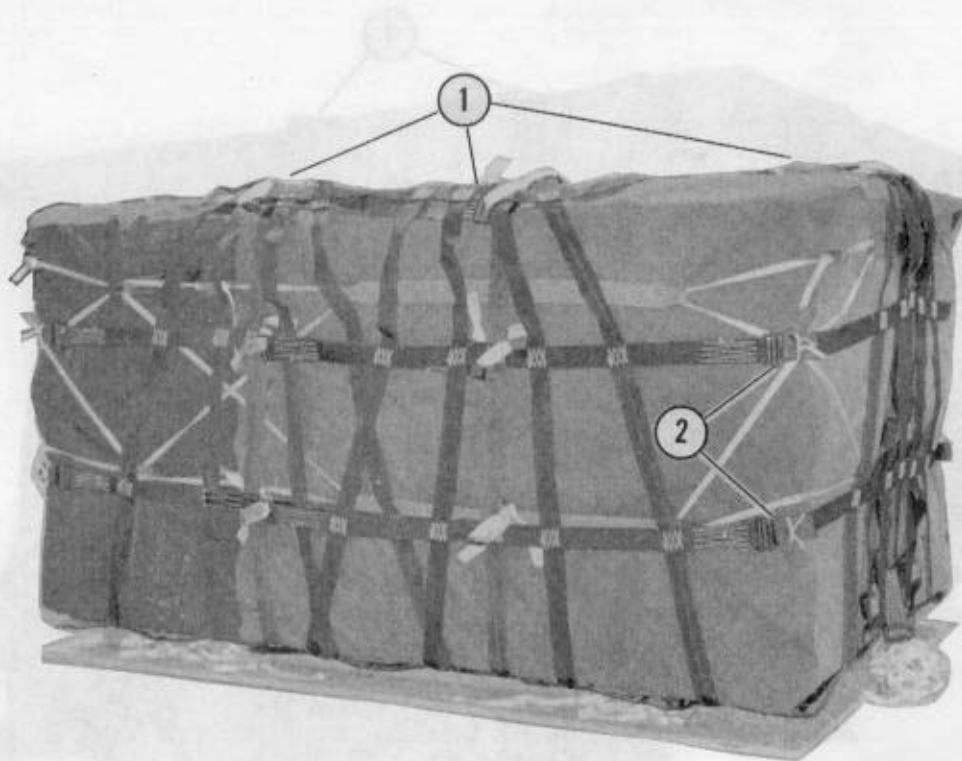

- 1 Lay the remaining portions of the sling assemblies over the load.
- 2 Route the lateral straps through the friction adapters and apply equal tension. Fold the excess and tape or tie it in place as shown in Figure 1-3.

Figure 9-29. Lateral straps secured

9-41. Securing Skid Board Ties

Secure the skid board ties as shown in Figure 9-30.

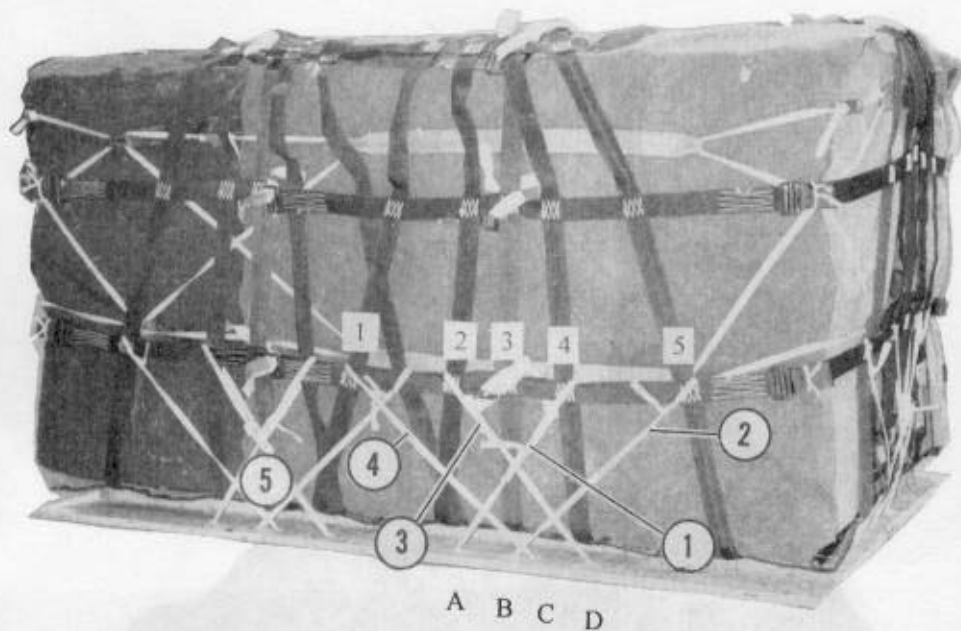

- ① Starting at the front right side, take tie-down A and diagonally tie it around the intersection of the lower lateral strap and fourth support web. Use three half-hitch knots and an overhand knot in the running end.
- ② Route tie-down B around the fifth support web and lower lateral strap intersection diagonally. Pull the excess slack out, and tie it with trucker's hitch knot and an overhand knot in the running end.
- ③ Repeat step 1 for tie-down D and secure it to the second intersection on the lower lateral strap.
- ④ Repeat step 2 for tie-down C and secure it to the first intersection on the lower lateral strap.
- ⑤ Repeat steps 1 through 4 for the other five sets of tie-downs.

Figure 9-30. Skid board ties secured

9-42. Installing Suspension Slings

Install suspension slings using six suspension webs, two 3/4-inch cargo suspension clevises, and two 3-foot (2-loop), type XXVI nylon webbing slings as shown in Figure 9-31.

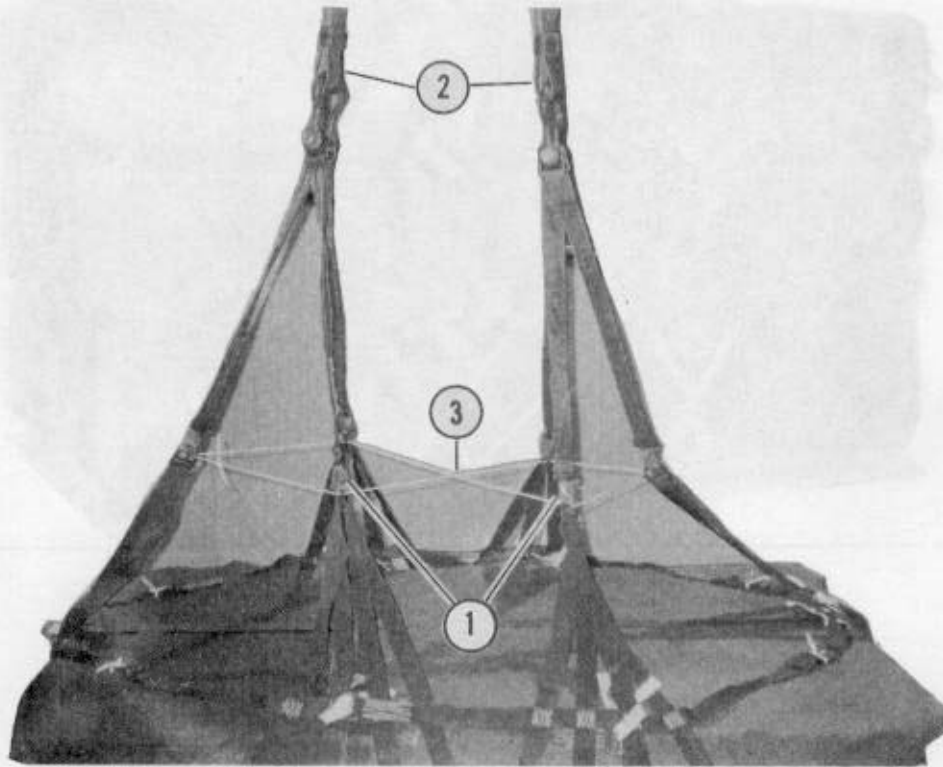

- ① Attach one suspension web to each of the six D-rings. Route the snap hook from outside to inside. Wrap each hook with masking tape.
- ② Place a 3-foot sling on each clevis. Bolt the three suspension webs at the front of the load to one clevis. Repeat step for the rear set.
- ③ Route a length of type III nylon cord through the six D-rings as shown above. Tie the ends together. Make sure the tie has excess to allow suspension sling movement.

Note: After positioning the type III nylon cord, fold and tape the excess with masking tape (not shown).

Figure 9-31. Suspension slings installed

9-43. Installing Parachute

Install a G-12E cargo parachute as shown in Figure 9-32.



- ① Place a G-12E cargo parachute on the load with the riser compartment up and the bridle toward the front of the load. Position the parachute on the front of the load.
- ② Tie each corner of the parachute to the sling assembly using type I, 1/4-inch cotton webbing.
- ③ Bolt the two 3-foot slings to the parachute's cargo suspension clevis. Make sure the risers from the parachute are not removed from the clevis.
- ④ Fold and tape the excess sling with masking tape (not shown).

Figure 9-32. G-12E cargo parachute installed

9-44. Marking Rigged Load

Mark the rigged load according to Chapter 1. Compute the rigged load data.

9-45. Equipment Required

Use the equipment listed in Table 9-5 to rig the load shown in Figure 9-33.

CAUTION

Make the final inspection required by Chapter 1 before the load leaves the rigging site. If the load includes hazardous material as defined in AFJMAN 24-204/TM 38-250, complete Shipper's Declaration for Dangerous Goods form.

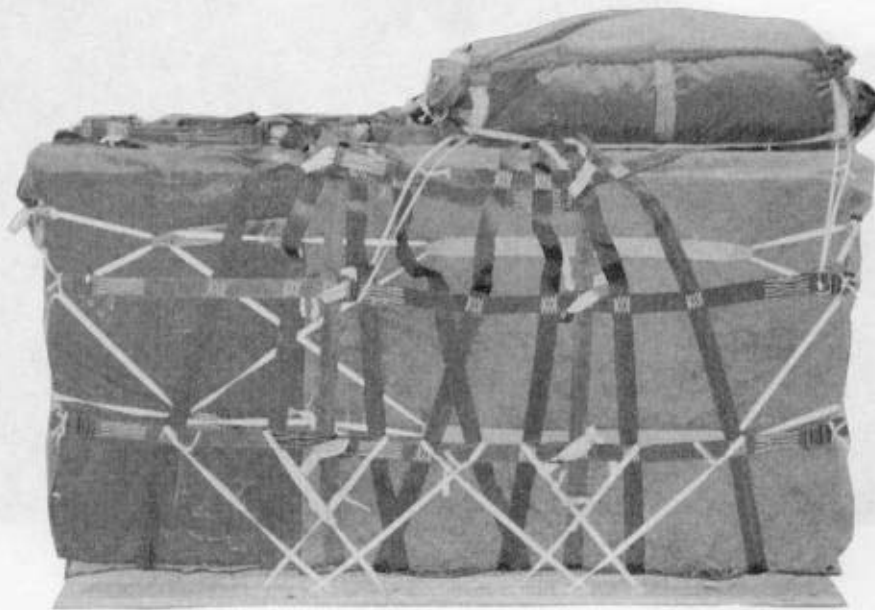

RIGGED LOAD DATA

Weight (without parachute)	900 - 2,200 pounds
Parachute	G-12E

Figure 9-33. Stretch A-22 cargo bag rigged for low-velocity airdrop

Table 9-5. Equipment required for rigging stretch A-22 cargo bag for low-velocity airdrop

National Stock Number	Item	Quantity
1670-00-587-3421	Bag, cargo, A-22	2
4030-00-678-8562	Clevis, suspension, 3/4-in (medium)	3
1670-00-753-3928	Pad, energy-dissipating, honeycomb,	2 sheets
	3- by 36- by 96-in:	(2)
	36- by 68-in	
	Parachute:	
1670-01-065-3755	Cargo, G-12E	1
1670-00-216-7297	Pilot, 68-in diam	1
5530-00-128-4981	Plywood, 3/4- by 48- by 96-in	1 sheet
	or	
No NSN	Plywood, 1- by 48- by 96-in	1 sheet
1670-01-062-6301	Sling, cargo, airdrop, 3-ft (2-loop),	
	type XXVI nylon webbing	2
1670-00-368-7486	Strap, webbing, nylon (shear strap),	
	60-in	1
7510-00-266-6710	Tape, masking, 2-in	As required
	Webbing:	
8305-00-268-2411	Cotton, 1/4-in, type I	As required
	Nylon:	
8305-00-082-5752	Tubular, 1/2-in	As required
8305-00-263-3591	Type VIII	As required
	or	
8305-00-268-2455	Tubular, 1-in, OD	As required

CHAPTER 10 RIGGING SPECIFIC SINGLE A-22 LOADS

Section I RIGGING TRAY-PACK RATIONS FOR LOW-VELOCITY AIRDROP

10-1. Description of Load

This load consists of 48 cases of tray-pack rations. Each case contains four rations. The case measures 9 by 13 by 11 inches and weighs about 28 pounds. This load is rigged in an A-22 cargo bag for low-velocity airdrop.

10-2. Preparing Load

Stack 48 cases of rations on a pallet in a square formation.

10-3. Preparing Skid Board

Prepare a 48- by 48-inch skid board as shown in Figure 9-1.

10-4. Positioning Honeycomb

Cut and position the honeycomb as shown in Figure 10-1.

10-5. Rigging Load

Rig the load according to Figures 9-3 through 9-7.

10-6. Installing Parachute

Install a G-12E cargo parachute according to Chapter 8.

10-7. Marking Rigged Load

Mark the rigged load according to Chapter 1 using the data given in Figure 10-2. If the load varies from the one shown in Figure 10-2, recompute the rigged load data.

Note: This drawing is not drawn to scale.

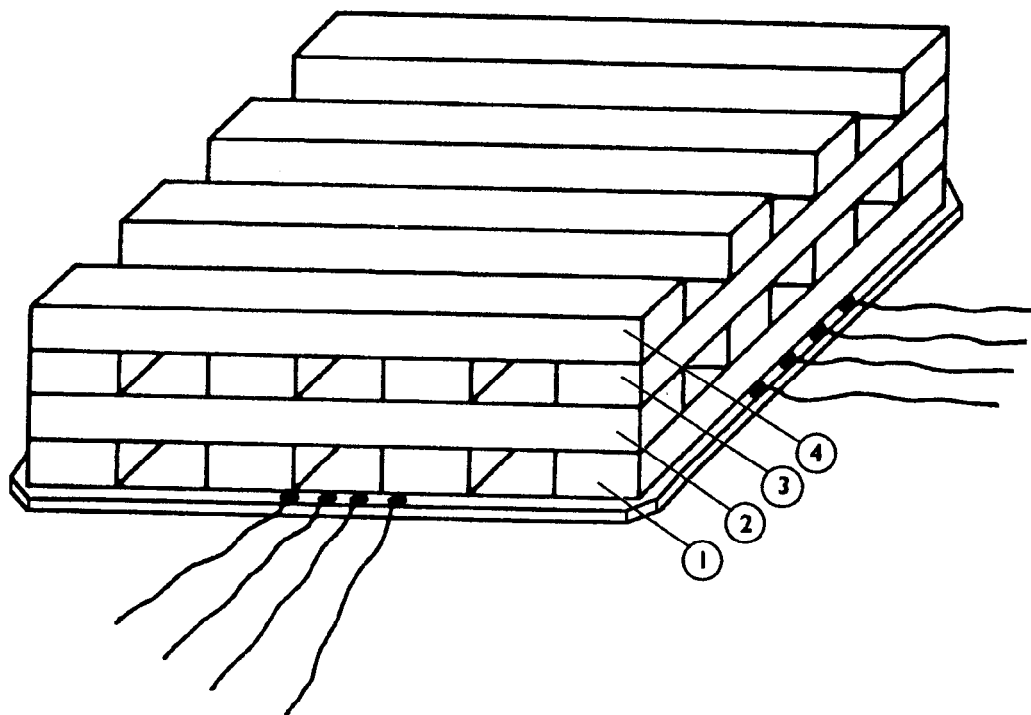

- ① Cut sixteen 6- by 44-inch pieces of honeycomb (not shown).
- ② Evenly space four honeycomb pieces on the platform. Make sure the honeycomb pieces are 2 inches from all sides.
- ③ Repeat step 2 except alternate the honeycomb pieces in the second layer of honeycomb.
- ④ Repeat step 3 for the third layer of honeycomb.
- ⑤ Repeat step 3 for the fourth layer of honeycomb.

Figure 10-1. Honeycomb positioned

10-8. Equipment Required

Use the equipment listed in Table 10-1 to rig the load shown in Figure 10-2.

CAUTION

Make the final inspection required by Chapter 1 before the load leaves the rigging site. If the load includes hazardous material as defined in AFJMAN 24-204/TM 38-250, complete Shipper's Declaration for Dangerous Goods form.

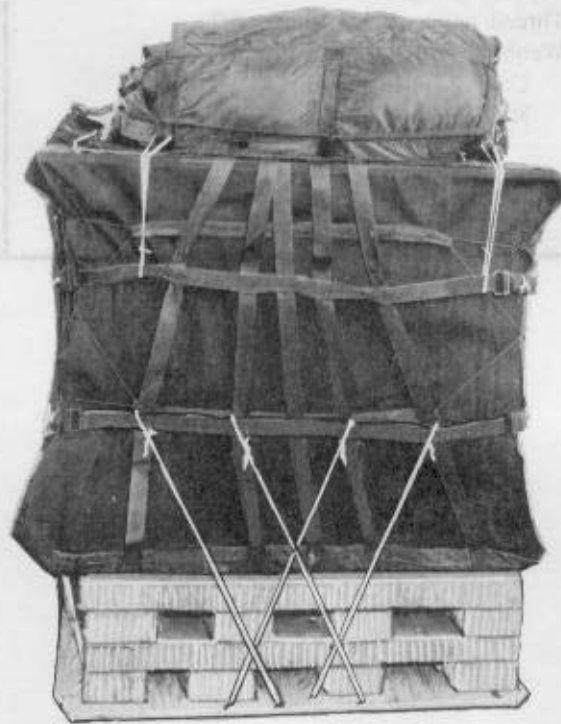

RIGGED LOAD DATA

Weight (with parachute)	1,860 pounds
Height (with parachute)	64 inches
Width	48 inches
Length	48 inches
Parachute	G-12E

Figure 10-2. Forty-eight cases of tray-pack rations rigged in an A-22 container for low-velocity airdrop

Table 10-1. Equipment required for rigging tray-pack rations in an A-22 container for low-velocity airdrop

National Stock Number	Item	Quantity
8040-00-273-8713	Adhesive, paste, 1-gal	As required
1670-00-587-3421	Bag, cargo, A-22	1
4020-00-240-2146	Cord, nylon, type III, 550-lb	As required
1670-00-753-3928	Pad, energy-dissipating, honeycomb, 3- by 36- by 96-in: 6- by 44-in	1 sheet (16)
1670-01-065-3755	Parachute, cargo, G-12E	1
5530-00-914-5118	Plywood, 1- by 48- by 48-in	1 sheet
7510-00-266-6710	Tape, masking, 2-in	As required
8310-00-102-4478	Thread, cotton, ticket number 8/7	As required
	Webbing:	
8305-00-268-2411	Cotton, 1/4-in, type I	As required
8305-00-082-5752	Nylon, tubular, 1/2-in	As required

Section II
RIGGING COMPANY-LEVEL FIELD FEEDING KITCHEN
FOR LOW-VELOCITY AIRDROP

10-9. Description of Load

The company-level field feeding kitchen and eight boxes of tray packs are rigged in an A-22 cargo bag for low-velocity airdrop. Table 10-2 lists the

components and items that make up the kitchen. The unrigged kitchen weighs 876 pounds. The load requires one G-12E cargo parachute.

Table 10-2. Components and items of the company-level field feeding kitchen

COMPONENTS LIST	BASIC ISSUE ITEMS
1 Heater cabinet 1 M2/M2A burner unit 1 Small beverage transporter 1 Large beverage transporter 2 Remote food transporters 1 Work and serving table 1 Complete pot-cradle assembly	1 Antiseize compound 3 Water-sterilizing bags 1 Cutting board 1 Wire brush 1 Friction top can 2 5-gallon gasoline cans 1 Hand can opener 1 Tray-pack can opener 2 5-gallon water cans 1 Burner slot cleaner 1 Fire extinguisher 1 First aid kit 1 Preheater generator 1 Drain hose 1 Inflating pump hose 1 Boning knife 1 Bread knife 1 Gasoline lantern 1 Tray-pack lifter 1 Tray-pack serving lifter 1 2-quart liquid measure 1 Gasoline can spout nozzle 1 10-gallon stock pot with cover 1 15-gallon stock pot with cover 1 Inflating pump 1 Flat screwdriver 1 Food serving basting spoon 1 15-inch slotted serving spoon 1 Tool kit 1 Food turner 1 Adjustable crescent wrench 1 Combination wrench

10-10. Preparing Skid Board

Prepare a skid board as shown in Figure 9-1.

10-11. Positioning Honeycomb

Position the honeycomb as shown in Figure 10-3.

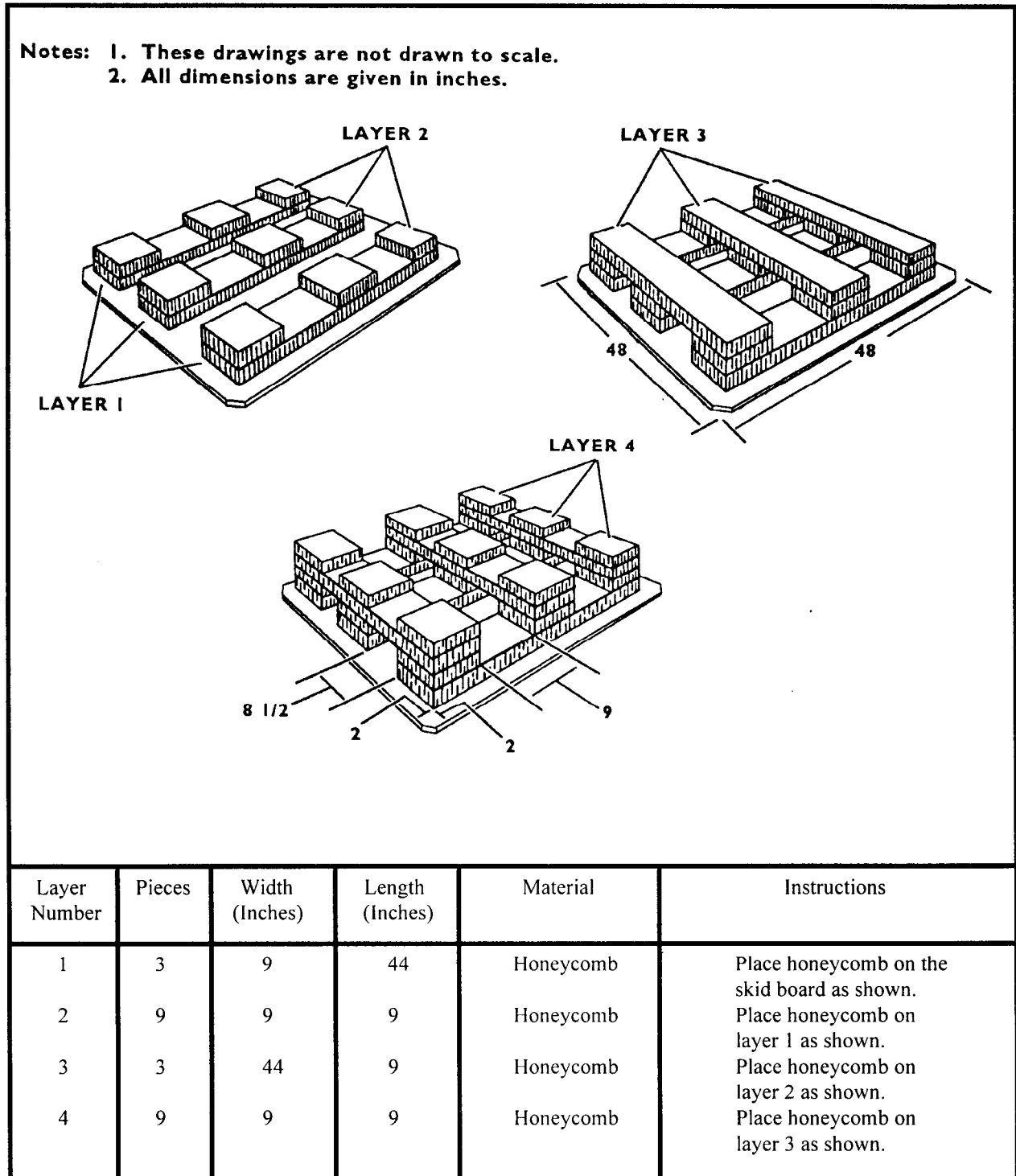

Figure 10-3. Honeycomb layers prepared and positioned

10-12. Positioning Container, Base, and Leg Braces

Center the A-22 sling assembly and cover on the honeycomb. Prepare the base as shown in Figure 10-4.

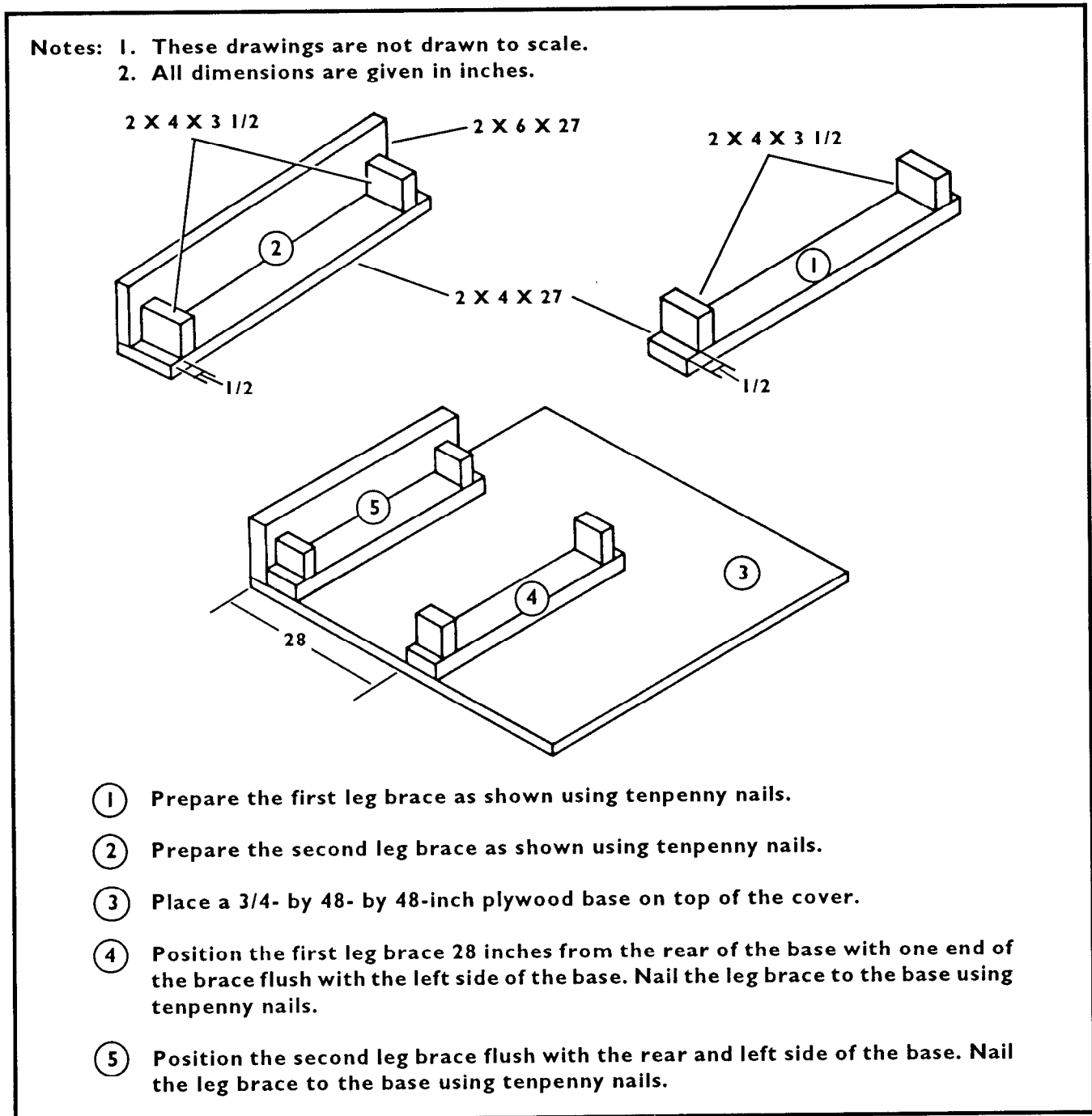
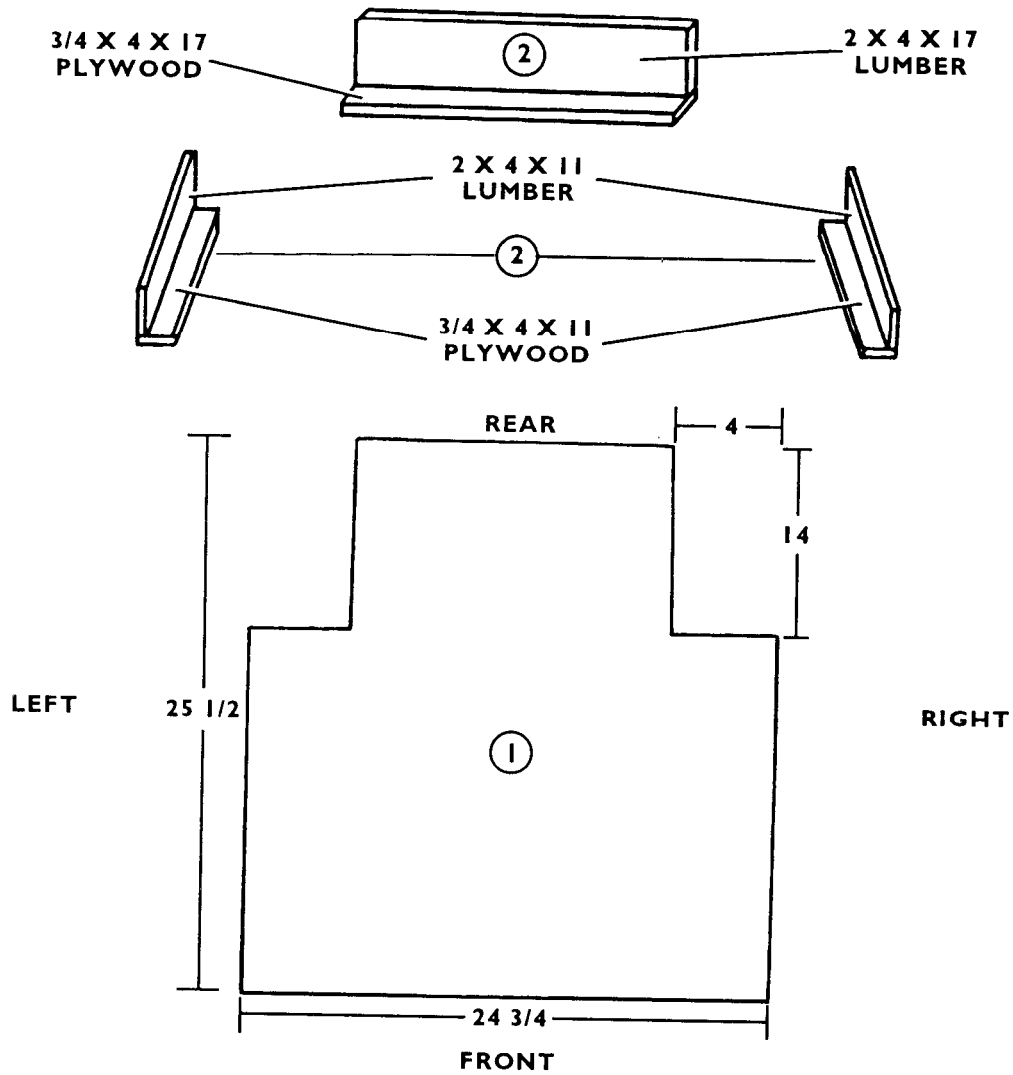

Figure 10-4. Base positioned and leg braces positioned and secured

10-13. Preparing Heater Cabinet

Prepare the heater cabinet as shown in Figure 10-5.

- Notes: 1. These drawings are not drawn to scale.
 2. All dimensions are given in inches.



- ① Make a 4- by 14-inch cutout in each rear corner of a 3/4- by 24 3/4- by 25 1/2-inch piece of plywood. This plywood will be placed in step 4.
- ② Build three woodblocks as shown. Nail the lumber and plywood together using sixpenny nails. The woodblocks will be placed in steps 5, 6, and 7.

Figure 10-5. Heater cabinet prepared

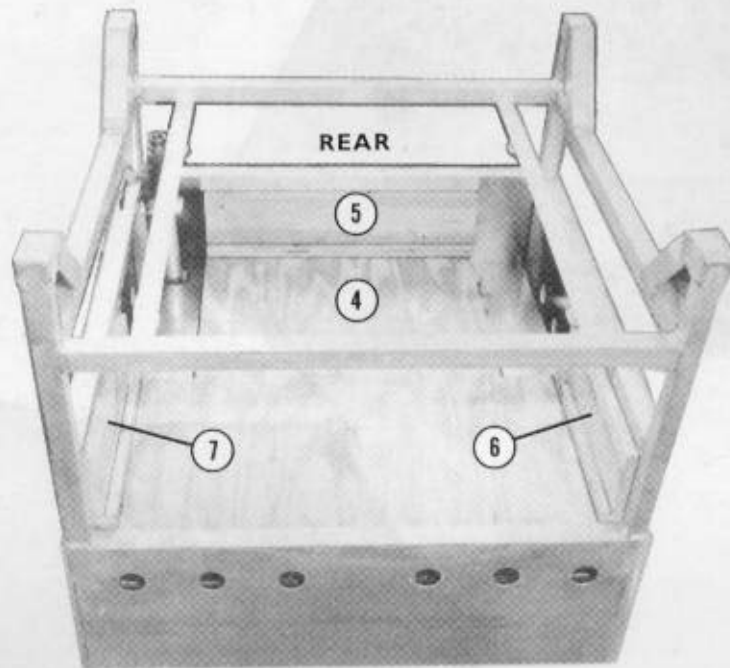

- ③ Turn the heater cabinet upside down. Place a 17- by 25-inch piece of honeycomb (not shown) in the bottom of the cabinet.
- ④ Place the 3/4- by 24 3/4- by 25 1/2-inch piece of plywood in the bottom of the heater cabinet with the cutouts to the rear.
- ⑤ Wedge the 4- by 17-inch woodblock between the rear rail and the plywood in the bottom of the heater cabinet.
- ⑥ Wedge one 4- by 11-inch woodblock between the left side rail and the plywood in the bottom of the heater cabinet.
- ⑦ Wedge the other 4- by 11-inch woodblock between the right side rail and the plywood in the bottom of the heater cabinet.

Figure 10-5. Heater cabinet prepared (continued)

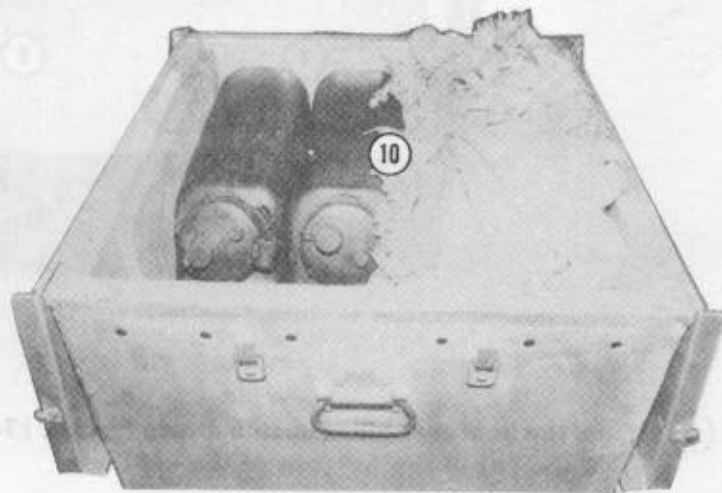
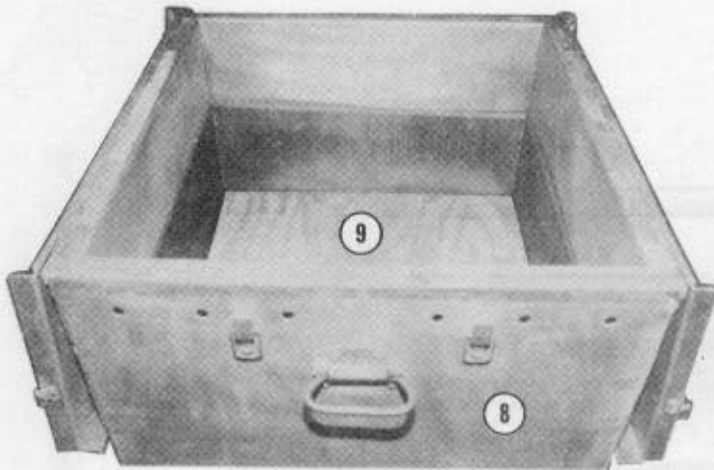

- ⑧ Turn the heater cabinet over so that the top side is up.
- ⑨ Place a 3/4- by 23 3/4- by 23 3/4-inch piece of plywood inside the cabinet.
- ⑩ Wedge the tool kit, the cutting board, two filled water cans, the tray-pack can opener, the hand can opener, and the antiseize compound inside the heater cabinet. Pad them with cellulose wadding.

Figure 10-5. Heater cabinet prepared (continued)

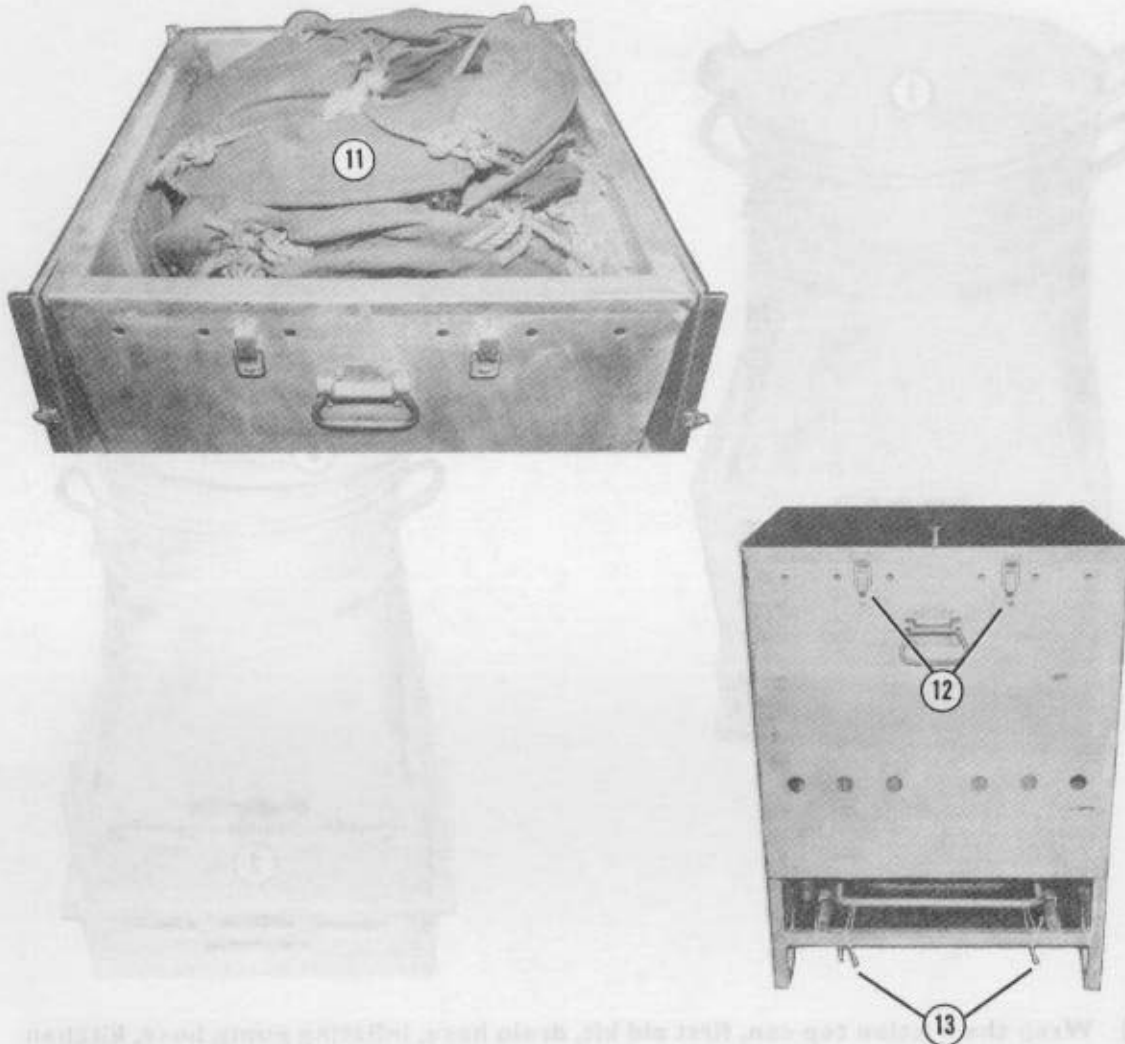

- ① Place the water-sterilizing bags on top of the items.
- ② Close and latch the cover.
- ③ Place the burner unit on the shelf provided under the heater cabinet. Tie the burner unit in place with type III nylon cord.

Figure 10-5. Heater cabinet prepared (continued)

10-14. Preparing Pot Assembly

Prepare the pot assembly as shown in Figure 10-6.

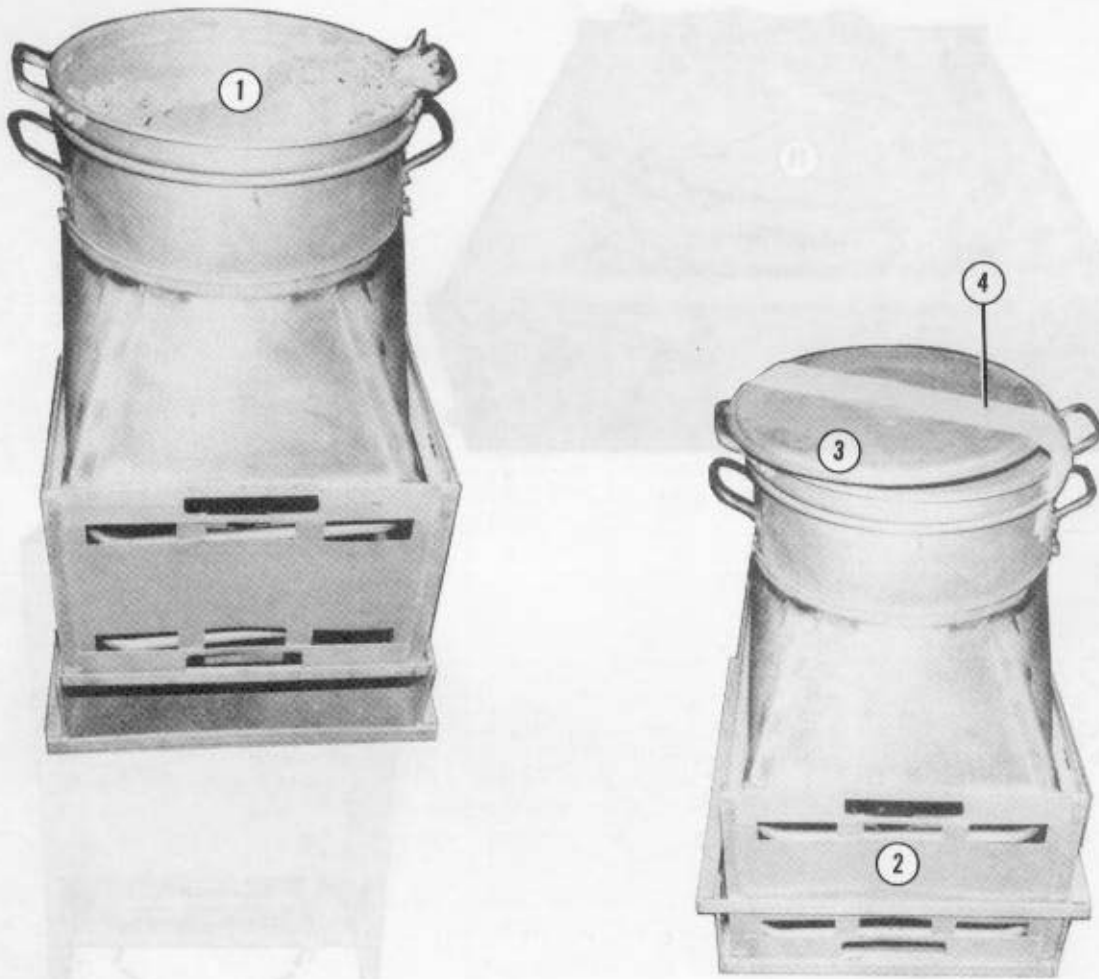

- ① Wrap the friction top can, first aid kit, drain hose, inflating pump hose, kitchen utensils, tray-pack lifter, tray-pack serving lifter, liquid measure, and inflating pump with cellulose wadding. Place these items inside the pot assembly.
- ② Remove the pot assembly from the base, turn the base upside down, and replace the pot assembly on the base.
- ③ Place the cover on the pot, and place the second cover on top of the first.
- ④ Tape the covers to the pot assembly.

Figure 10-6. Pot assembly prepared

10-15. Positioning Load

Position the load as shown in Figure 10-7.

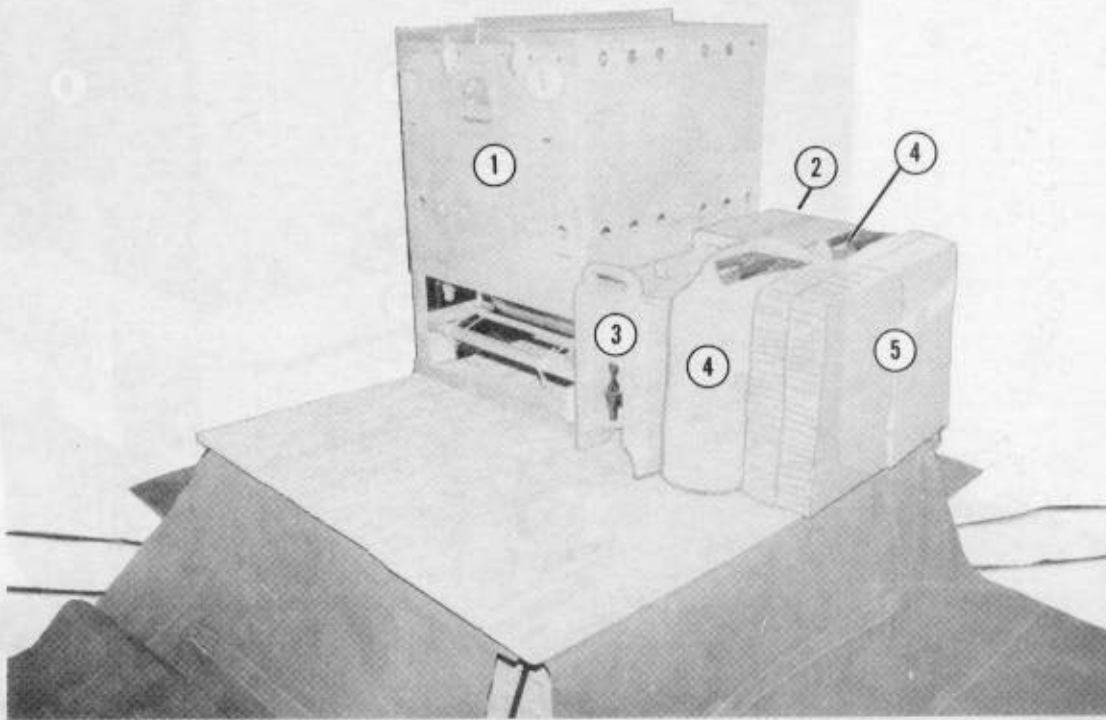

Position the components of the field kitchen on the cargo bag in the exact sequence shown in this figure. Pad various components as shown with wadding or honeycomb. Position the components in the following order:

- ① Heater cabinet (positioned on the previously placed leg supports)
- ② Two boxes of tray packs (T-rations)
- ③ Small beverage transporter
- ④ Two 5-gallon cans of gasoline wrapped in cellulose wadding
- ⑤ Three 12- by 18-inch pieces of honeycomb

Figure 10-7. Load positioned

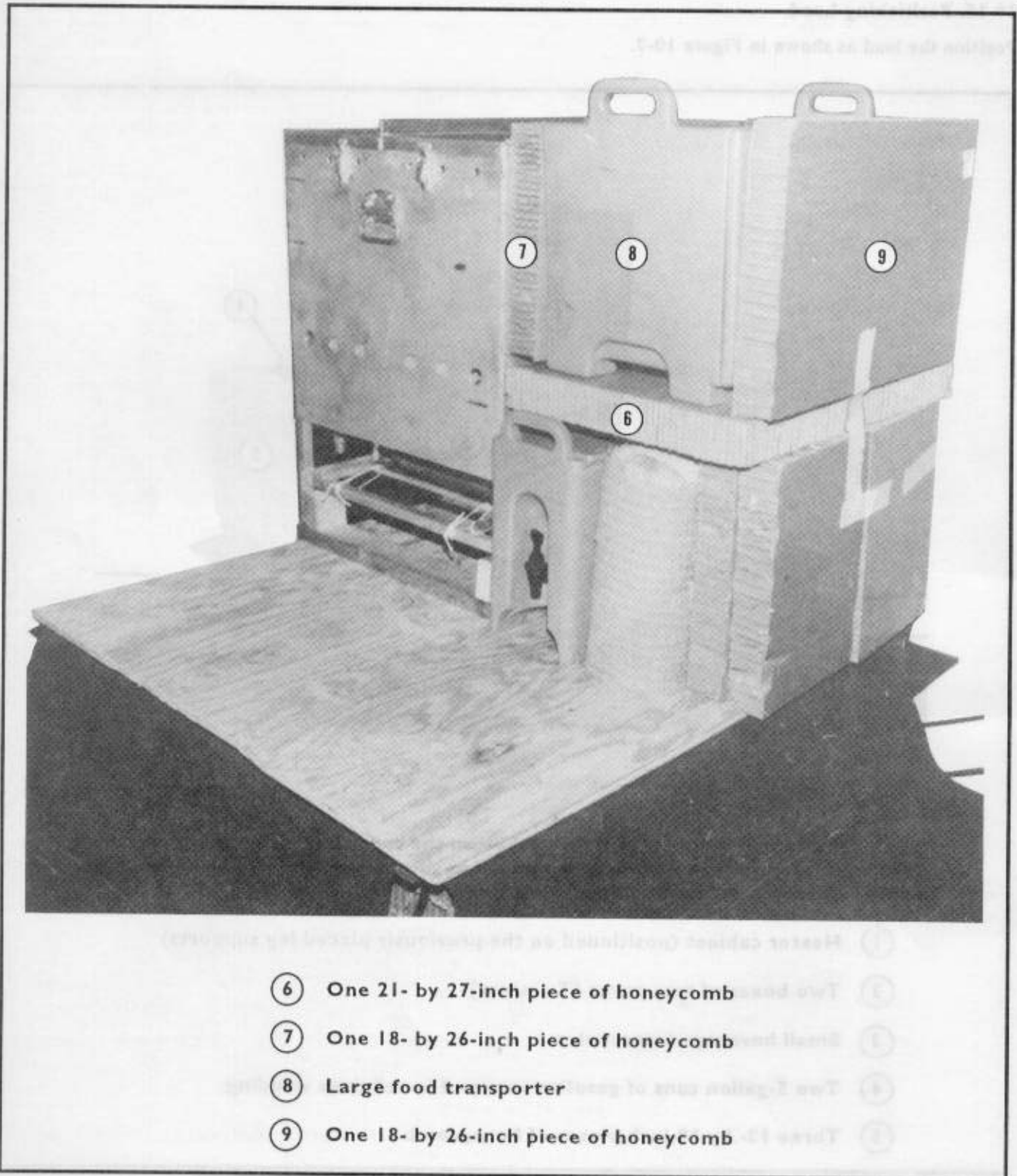
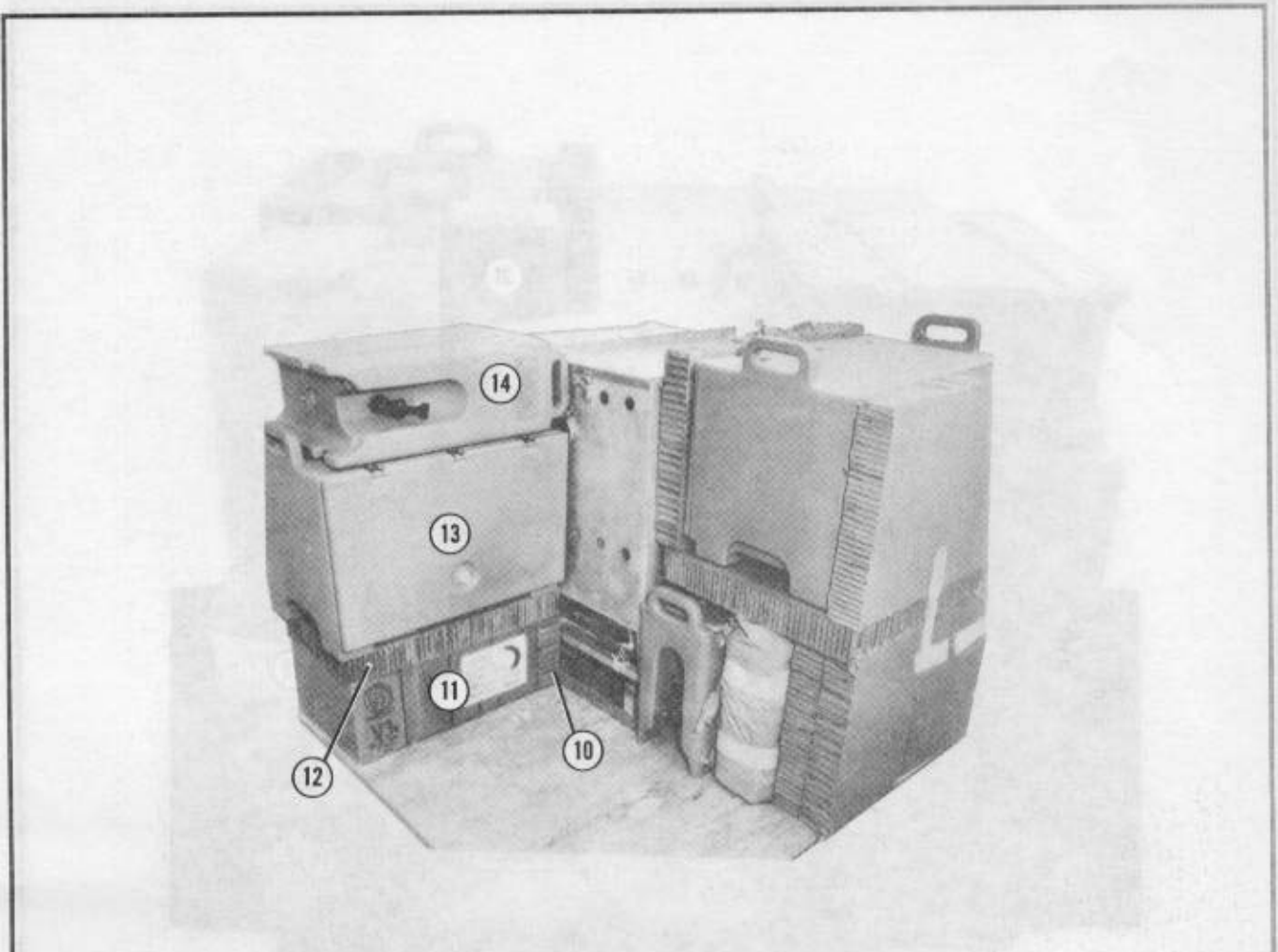

Figure 10-7. Load positioned (continued)



- ⑩ One 9- by 13-inch piece of honeycomb
- ⑪ Two boxes of tray packs
- ⑫ One 14- by 25-inch piece of honeycomb
- ⑬ Large food transporter
- ⑭ Large beverage transporter

Figure 10-7. Load positioned (continued)



- ⑮ Pot assembly and burner unit
- ⑯ Two boxes of tray packs
- ⑰ One 9- by 25-inch piece of honeycomb
- ⑱ Two boxes of tray packs
- ⑲ Two 8- by 18-inch pieces of honeycomb
- ⑳ Large beverage transporter
- ㉑ Gasoline lantern

Figure 10-7. Load positioned (continued)

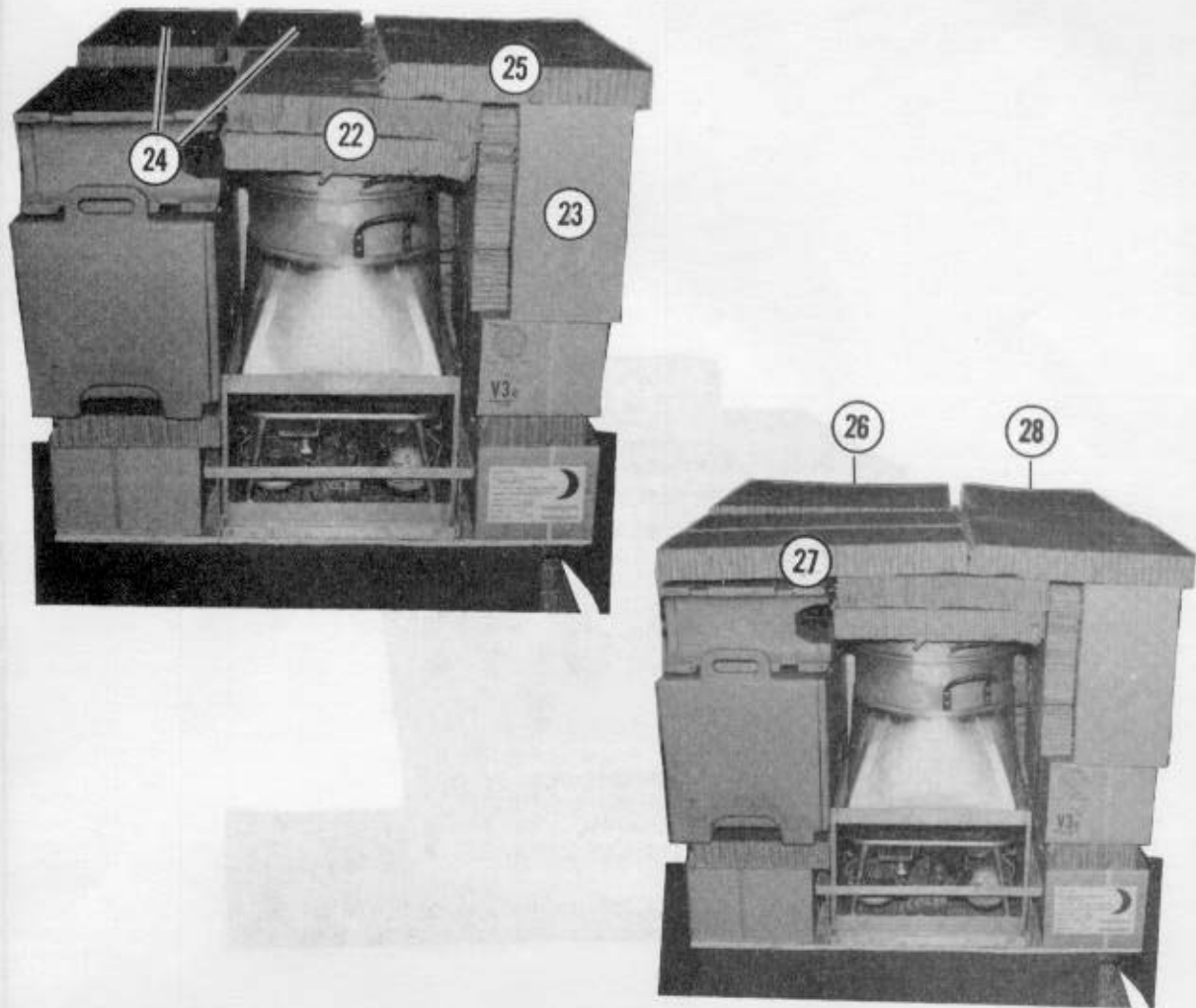

- ②② Two 20- by 24-inch pieces of honeycomb
- ②③ One 9- by 18-inch piece of honeycomb
- ②④ Two 13- by 27-inch pieces of honeycomb
- ②⑤ One 21- by 30-inch piece of honeycomb
- ②⑥ One 26- by 37-inch piece of honeycomb
- ②⑦ One 17- by 25-inch piece of honeycomb
- ②⑧ One 7- by 25-inch piece of honeycomb

Figure 10-7. Load positioned (continued)

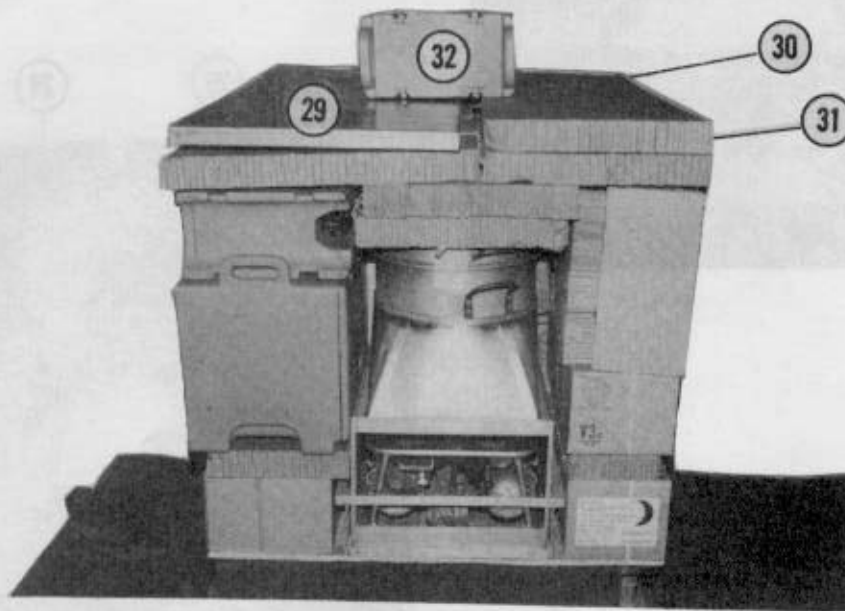

- ②⑨ Work and serving table
- ③⑩ One 19- by 21-inch piece of honeycomb
- ③⑪ One 21- by 36-inch piece of honeycomb
- ③⑫ Small beverage transporter

Figure 10-7. Load positioned (continued)

10-16. Closing Container

Close the container according to Figures 9-3 through 9-7.

10-17. Completing Rigged Load and Installing Parachute

Complete the rigging of the load and install a G-12E cargo parachute as shown in Figure 10-8.

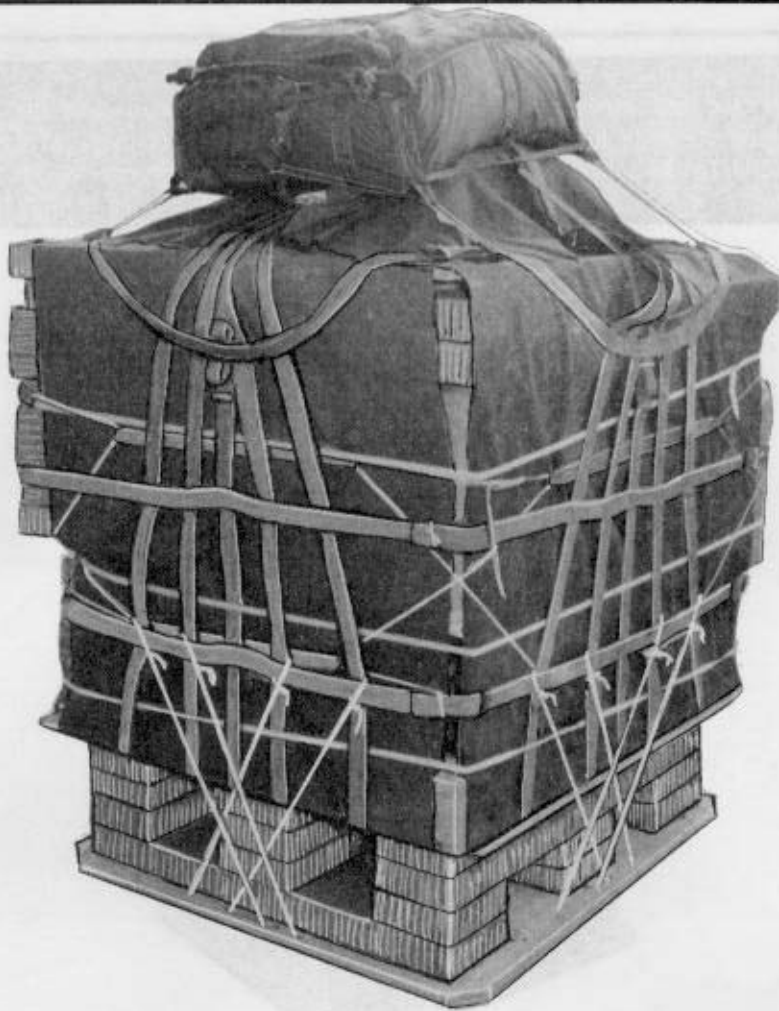

- 1 Pass a length of 1/2-inch tubular nylon webbing around the A-22 cargo bag. Run the webbing under the vertical straps between the upper and middle horizontal straps. Pull the ends of the webbing tight, and tie the ends together.
- 2 Run two lengths of 1/2-inch tubular nylon webbing around the A-22 cargo bag and through the vertical straps. Run one length below the second horizontal strap and one below the third. Pull the ends of the webbing tight, and tie the ends together.
- 3 Secure the skid board ties to the load as shown in Figure 9-6.
- 4 Install a G-12E cargo parachute according to Chapter 8.

Figure 10-8. Rigged load completed and G-12E cargo parachute installed

10-18. Marking Rigged Load

Mark the rigged load according to Chapter 1 using the data given in Figure 10-9. If the load varies from the one shown in Figure 10-9, recompute the rigged load data.

10-19. Equipment Required

Use the equipment listed in Table 10-3 to rig the load shown in Figure 10-9.

CAUTION

Make the final inspection required by Chapter 1 before the load leaves the rigging site. If the load includes hazardous material as defined in AFJMAN 24-204/TM 38-250, complete Shipper's Declaration for Dangerous Goods form.

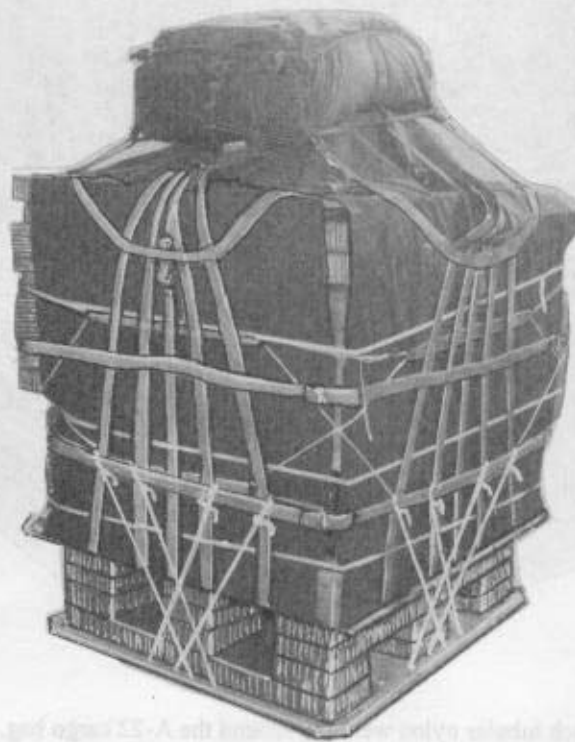

RIGGED LOAD DATA

Weight (with parachute)	1,270 pounds
Height (with parachute)	85 inches
Width	48 inches
Length	48 inches
Parachute	G-12E

Figure 10-9. Company-level field feeding kitchen rigged in an A-22 container for low-velocity airdrop

Table 10-3. Equipment required for rigging the company-level field feeding kitchen in an A-22 container for low-velocity airdrop

National Stock Number	Item	Quantity
1670-00-587-3421	Bag, cargo, A-22	1
4020-00-240-2146	Cord, nylon, type III, 550-lb	As required
8135-00-664-6958	Cushioning material, packaging, cellulose wadding	As required
	Lumber:	
5510-00-220-6446	2- by 4-in:	
	3 1/2-in	4
	11-in	2
	17-in	1
	27-in	2
5510-00-220-6448	2- by 6- by 27-in	1
	Nail, steel wire, common:	
5315-00-010-4657	6d	As required
5315-00-010-4661	10d	As required
1670-00-753-3928	Pad, energy-dissipating, honeycomb,	
	3- by 36- by 96-in:	5 sheets
	7- by 25-in	(1)
	8- by 18-in	(2)
	9- by 9-in	(18)
	9- by 13-in	(1)
	9- by 18-in	(1)
	9- by 25-in	(1)
	9- by 44-in	(6)
	12- by 18-in	(3)
	13- by 27-in	(2)
	14- by 25-in	(1)
	17- by 25-in	(2)
	18- by 26-in	(2)
	19- by 21-in	(1)
	20- by 24-in	(2)
	21- by 27-in	(1)
	21- by 30-in	(1)
	21- by 36-in	(1)
	26- by 37-in	(1)
	Parachute:	
1670-01-065-3755	Cargo, G-12E	1
1670-00-216-7297	Pilot, 68-in diam	1
5530-00-128-4981	Plywood, 3/4-in:	3 sheets
	4- by 11-in	(2)
	4- by 17-in	(1)
	23 3/4- by 23 3/4-in	(1)
	24 3/4- by 25 1/2-in	(1)
	48- by 48-in	(1)

Table 10-3. Equipment required for rigging the company-level field feeding kitchen in an A-22 container for low-velocity airdrop (continued)

National Stock Number	Item	Quantity
1670-00-883-1654	Skid, cargo bag, platform, plywood (CDS)	1
7510-00-266-6710	Tape, masking, 2-in	As required
8310-00-102-4478	Thread, cotton, ticket number 8/7	As required
	Webbing:	
8305-00-268-2411	Cotton, 1/4-in, type I	As required
8305-00-082-5752	Nylon, tubular, 1/2-in	As required

Section III RIGGING PETROLEUM PRODUCTS

CAUTION

Make sure all petroleum products are packaged in POP standard drums and cans.

10-20. Description of Load

This section tells and shows how to rig sample loads of petroleum products. They will be rigged in an A-22 cargo bag. This section will show how to position the load only. The container is rigged as a typical A-22 load and the parachute is installed by normal procedures.

10-21. Preparing Skid Board and Positioning Honeycomb

Prepare the skid board and position the honeycomb according to Chapter 9.

10-22. Positioning Container

Center the sling assembly on the honeycomb stack. If desired, a cover may be used.

10-23. Positioning Load

Position the load as follows:

- a.* Use Figure 10-10 to position cases of oil.
- b.* Use Figure 10-11 to position 5-gallon drums.
- c.* Use Figure 10-12 to position 5-gallon fuel cans.

d. Use Figure 10-13 to position 30-gallon grease drums and cases of oil.

e. Use Figure 10-14 to position 55-gallon drums.

NOTES: 1. These procedures can be used to rig similar loads.
2. The load may consist of drums of oil, grease, fuel, or a combination.

10-24. Securing Container and Installing Parachute

Secure the container according to Figures 9-4 through 9-7. Install a G-12E cargo parachute according to Chapter 8.

10-25. Equipment Required

Use the equipment listed in Table 10-4 to rig the petroleum products. However, the equipment will vary from load to load.

Note: This drawing is not drawn to scale.

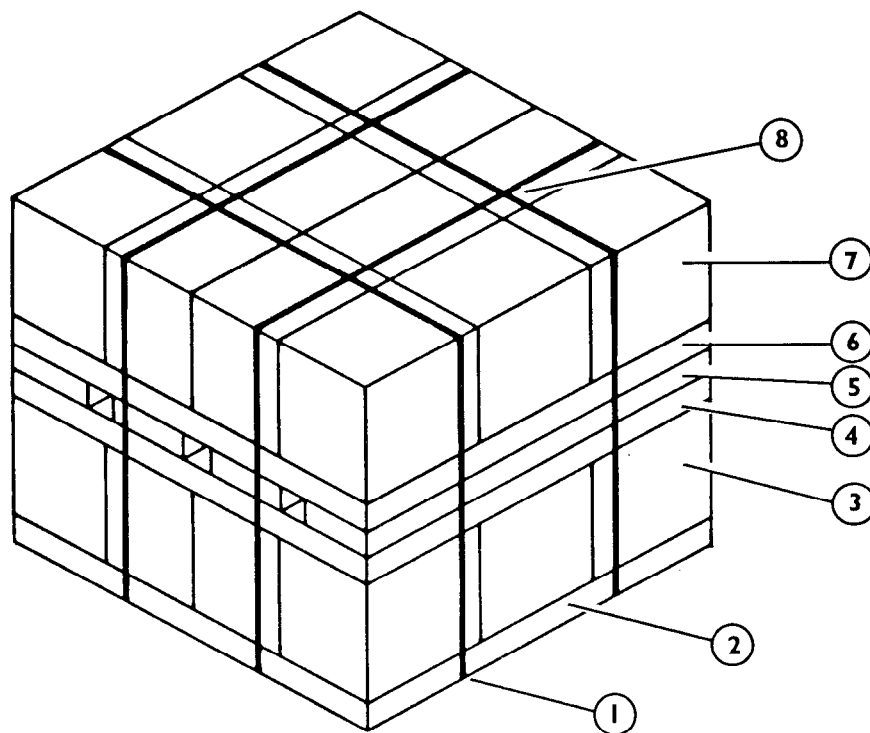

- ① Use four 20-foot lengths of steel strapping. Lay two lengths side to side on top of the container. Lay the other two lengths front to rear on top of the container. Adjust each length so that it is 8 inches from the edge.
- ② Center a 36- by 48-inch and a 12- by 48-inch piece of honeycomb side by side on top of the container.
- ③ Place 12 cases of oil on top of the honeycomb.
- ④ Form the second layer of honeycomb as described in step 2 except alternate the pieces of honeycomb.
- ⑤ Evenly space four 8- by 48-inch pieces of honeycomb on top of the second layer of honeycomb.
- ⑥ Form the fourth layer of honeycomb as described in step 2 except alternate the pieces of honeycomb.
- ⑦ Position 12 cases of oil on top of the honeycomb.
- ⑧ Bind the steel strapping over the top of the load. Use four seals to secure each piece of steel strapping. Cut off excess if necessary.

Figure 10-10. Cases of oil rigged

Note: This drawing is not drawn to scale.

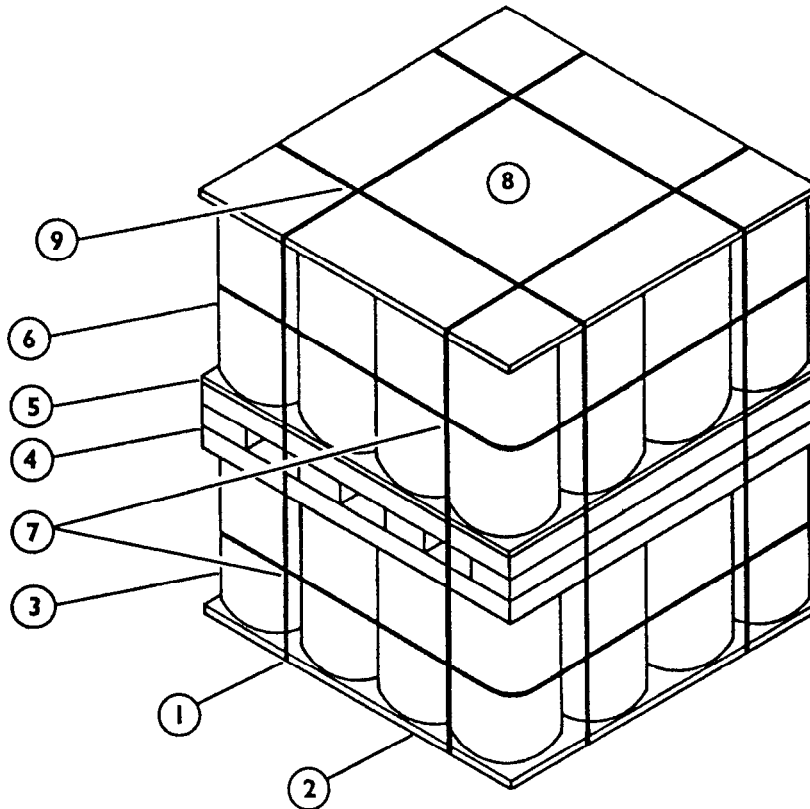

- ① Repeat step 1 of Figure 10-10.
- ② Center a 3/4- by 48- by 48-inch piece of plywood on top of the container.
- ③ Place sixteen 5-gallon drums on top of the plywood.
- ④ Repeat steps 4 through 6 of Figure 10-10 to form three layers of honeycomb.
- ⑤ Place a 3/4- by 48- by 48-inch piece of plywood on top of the honeycomb.
- ⑥ Position sixteen 5-gallon drums on top of the plywood.
- ⑦ Wrap a length of steel strapping around each layer of drums. Bind the strapping in place.
- ⑧ Place a 3/4- by 45- by 45-inch piece of plywood on top of the load.
- ⑨ Bind the steel strapping over the top of the load. Use four seals to secure each piece of steel strapping. Cut off excess if necessary. Pad the 5-gallon drums as necessary.

Figure 10-11. Five-gallon drums rigged

Note: This drawing is not drawn to scale.

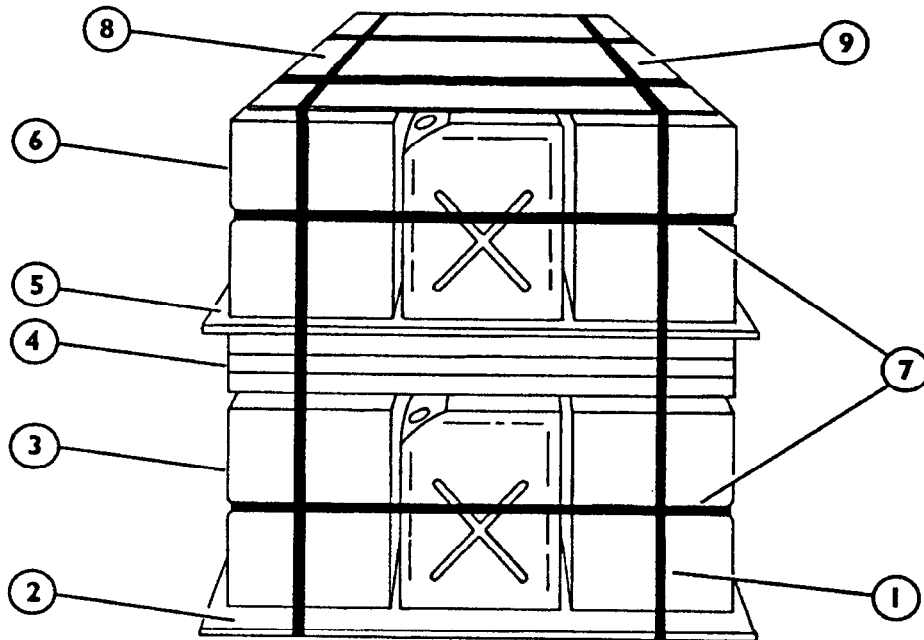

- ① Repeat step 1 of Figure 10-10.
- ② Center a 3/4- by 48- by 48-inch piece of plywood on top of the container.
- ③ Position 21 cans on top of the plywood (three rows wide and seven in each row). Wrap every other can with cellulose wadding or cardboard sheets.

Note: Make sure the 5-gallon cans are not more than 3/4 full.

- ④ Position three layers of honeycomb. Use a 36- by 48-inch and a 12- by 48-inch piece of honeycomb in each layer. Alternate the pieces of honeycomb in each layer.
- ⑤ Lay a 3/4- by 48- by 48-inch piece of plywood on top of the honeycomb layers.
- ⑥ Repeat step 3.
- ⑦ Wrap a length of steel strapping around each layer of cans. Bind the strapping in place.
- ⑧ Place a 3/4- by 44- by 44-inch piece of plywood on top of the load.
- ⑨ Bind the steel strapping over the top of the load. Use four seals to secure each piece of steel strapping. Cut off excess if necessary. Pad the 5-gallon cans as necessary.

Figure 10-12. Five-gallon fuel cans rigged

Note: This drawing is not drawn to scale.

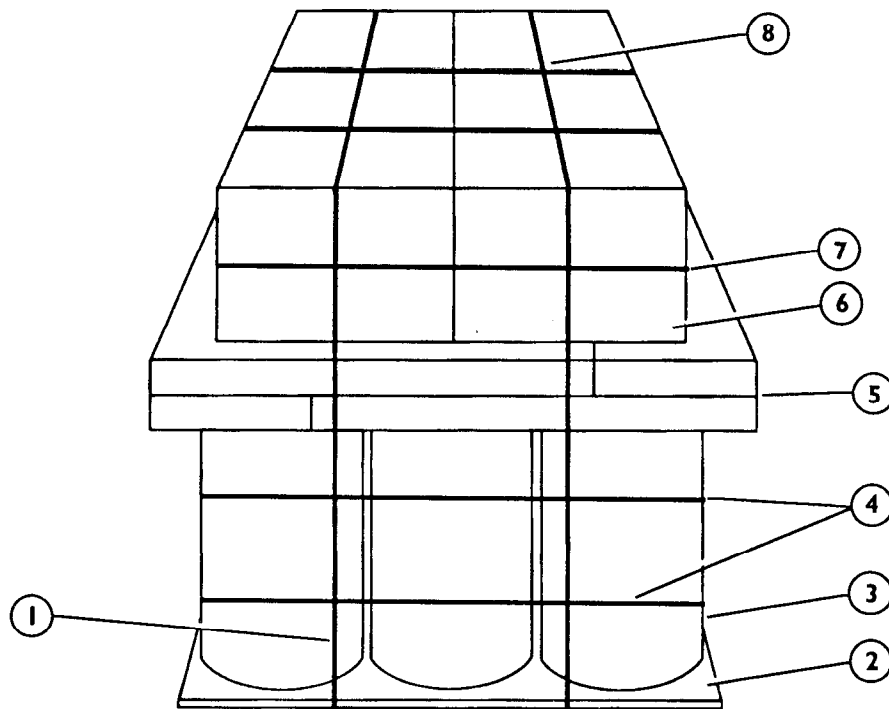

- ① Repeat step 1 of Figure 10-10.
- ② Center a 3/4- by 48- by 48-inch piece of plywood on top of the container.
- ③ Place nine 30-gallon drums on top of the plywood.
- ④ Evenly space two 18-foot lengths of steel strapping around the drums. Bind the strapping in place.
- ⑤ Position two layers of honeycomb. Use a 36- by 48-inch and a 12- by 48-inch piece of honeycomb in each layer. Alternate the pieces of honeycomb in each layer.
- ⑥ Place six cases of oil on top of the honeycomb.
- ⑦ Wrap a length of steel strapping around the cases. Bind the strapping in place.
- ⑧ Bind the steel strapping over the top of the load. Use four seals to secure each piece of steel strapping. Cut off excess if necessary. Pad the 5-gallon drums as necessary.

Figure 10-13. Thirty-gallon grease drums and cases of oil rigged

Note: This drawing is not drawn to scale.

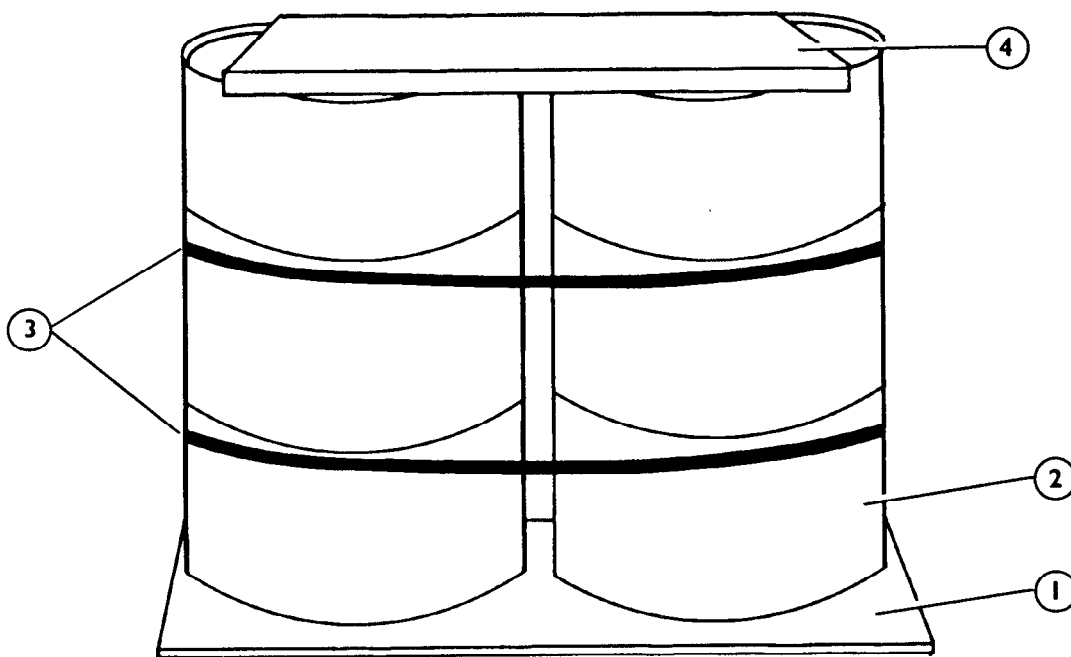

- ① Center a 3/4- by 48- by 48-inch piece of plywood on top of the container.
- ② Place four 55-gallon drums on top of the plywood.
- ③ Wrap two 16-foot lengths of 1/2-inch tubular nylon webbing around the drums. Make sure each length is just above the grooves on the drums. Secure each length of webbing together using a trucker's hitch knot.
- ④ Center a 3/4- by 36- by 36-inch piece of plywood on top of the load.

Figure 10-14. Fifty-five gallon drums rigged

Table 10-4. Equipment required for rigging petroleum products in an A-22 cargo bag

National Stock Number	Item	Quantity
8040-00-273-8713	Adhesive, paste, 1-gal	As required
1670-00-587-3421	Bag, cargo, A-22	1
4020-00-240-2146	Cord, nylon, type III, 550-lb	As required
8135-00-664-6958	Cushioning material, packaging, cellulose wadding	As required
1670-00-753-3928	Pad, energy-dissipating, honeycomb, 3- by 36- by 96-in	As required
1670-01-065-3755	Parachute, cargo: G-12E	1
1670-00-872-6109	High-velocity, 26-ft	1
5530-00-129-7777	Plywood: 1/2-in	As required
5530-00-128-4981	3/4-in	As required
1670-00-883-1654	Skid, cargo bag, platform, plywood (CDS)	1
8135-00-283-0667	Strapping, steel, 5/8-in	As required
7510-00-266-6710	Tape, masking, 2-in	As required
8310-00-102-4478	Thread, cotton, ticket number 8/7	As required
8305-00-268-2411	Webbing: Cotton, 1/4-in, type I	As required
8305-00-082-5752	Nylon, tubular, 1/2-in	As required

CHAPTER 11 RIGGING SPECIFIC DOUBLE A-22 LOADS FOR LOW-VELOCITY AIRDROP

Section I RIGGING SNOWMOBILE

11-1. Description of Load

The snowmobile is rigged in a double A-22 cargo bag for low-velocity airdrop. The load requires one G-12E cargo parachute equipped with a 68-inch pilot parachute. The snowmobile weighs 690 pounds unrigged. The length of the snowmobile is 118 inches, reducible to 104 inches. Its width is 36 inches. The height of the snowmobile is 49 inches, reducible to 47 inches. Twenty cases of rations are rigged with the snowmobile.

11-2. Preparing Skid Board

Prepare a standard double A-22 skid board as shown in Figures 9-12 and 9-13. Form two honeycomb layers using one 36- by 92-inch and one 8- by 92-inch piece

of honeycomb to form each layer. Alternate the pieces of honeycomb in each layer.

11-3. Positioning Container

Position two A-22 cargo bags as shown in Figures 9-14 and 9-15. Do NOT position the layer of honeycomb shown in Figure 9-15 (step 3).

11-4. Positioning Honeycomb

Position the honeycomb as shown in Figure 11-1.

NOTE: Various models of snowmobiles differ slightly and may require a modification to procedures.

Note: This drawing is not drawn to scale.

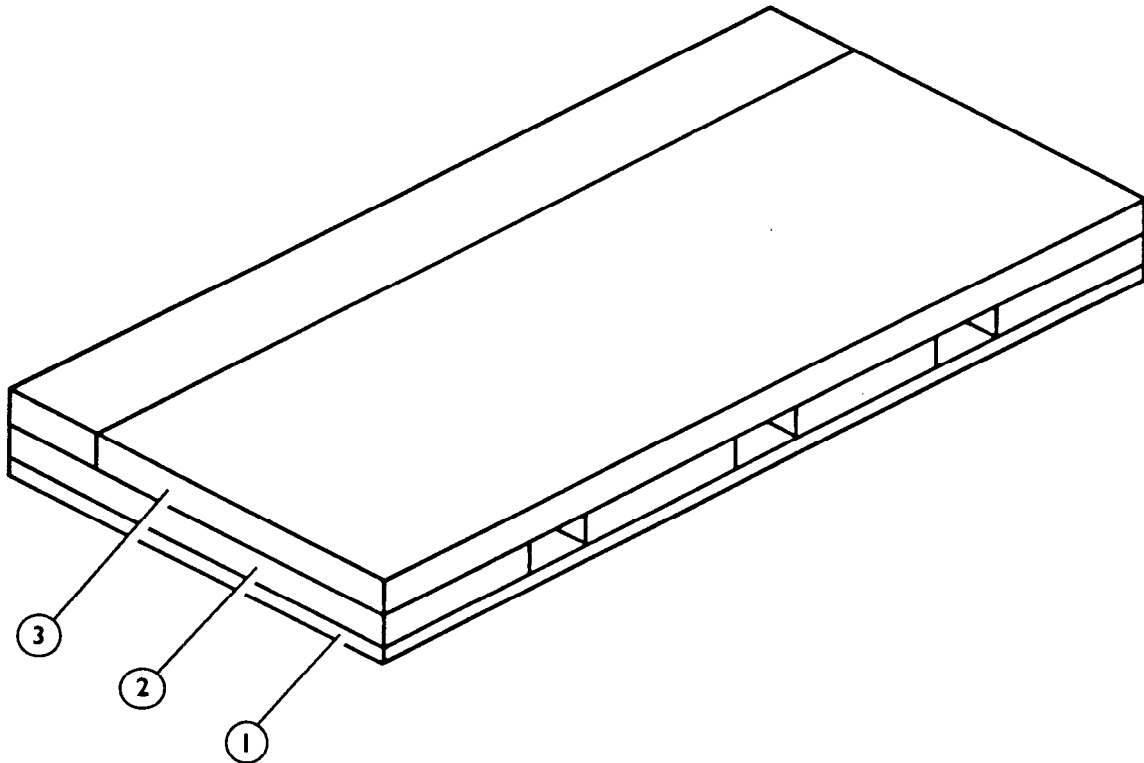

- ① Center a 3/4- by 48- by 96-inch piece of plywood on top of the cover.
- ② Evenly space four 18- by 48-inch pieces of honeycomb on top of the plywood.
- ③ Place a 36- by 96-inch and a 12- by 96-inch piece of honeycomb on top of the first layer of honeycomb.

Figure 11-1. Honeycomb positioned

Note: This drawing is not drawn to scale.

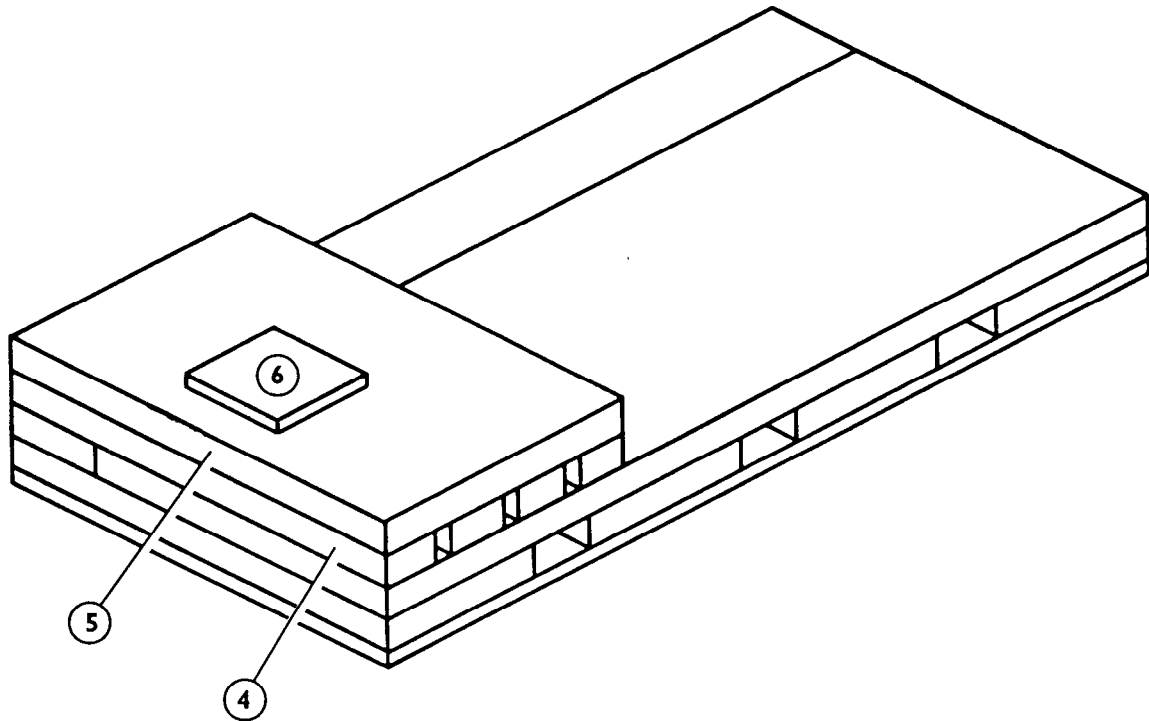

- ④ Cut four 6- by 48-inch pieces of honeycomb. Place one piece flush with the rear edge of the second layer of honeycomb. Place the remaining three pieces two inches apart from each other.
- ⑤ Place a 30- by 48-inch piece of honeycomb flush with the rear edge of the third layer of honeycomb.
- ⑥ Center a 3/4- by 12- by 12-inch piece of plywood 8 inches from the rear on top of the fourth layer of honeycomb.

Figure 11-1. Honeycomb positioned (continued)

11-5. Preparing Snowmobile

Prepare the snowmobile as shown in Figure 11-2.

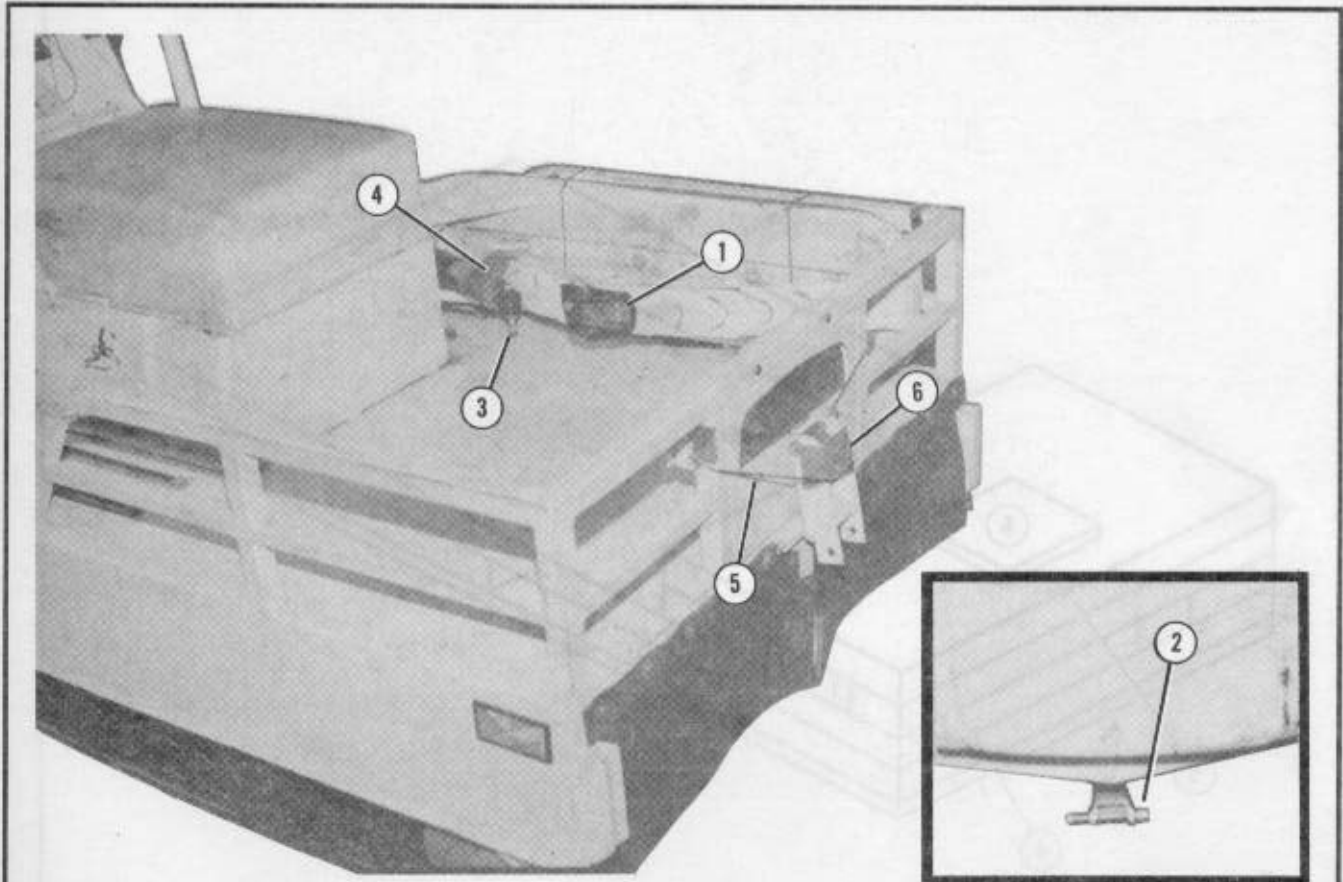

- ① Remove the front ski. Place the ski on the rear deck of the snowmobile, and tie it in place with type III nylon cord.
- ② Replace the bolt in the steering bracket, and tighten the nut.
- ③ Replace the bolt in the shock absorber of the ski, and tighten the nut.
- ④ Tape the shock absorber to the spring of the ski with masking tape.
- ⑤ Remove the stabilizing pin from the rear towing point, and place it in the toolbox. Fold the towing point up, and tie it in place with a length of type III nylon cord.
- ⑥ Tape the latch on the towing point with masking tape.

Figure 11-2. Snowmobile prepared

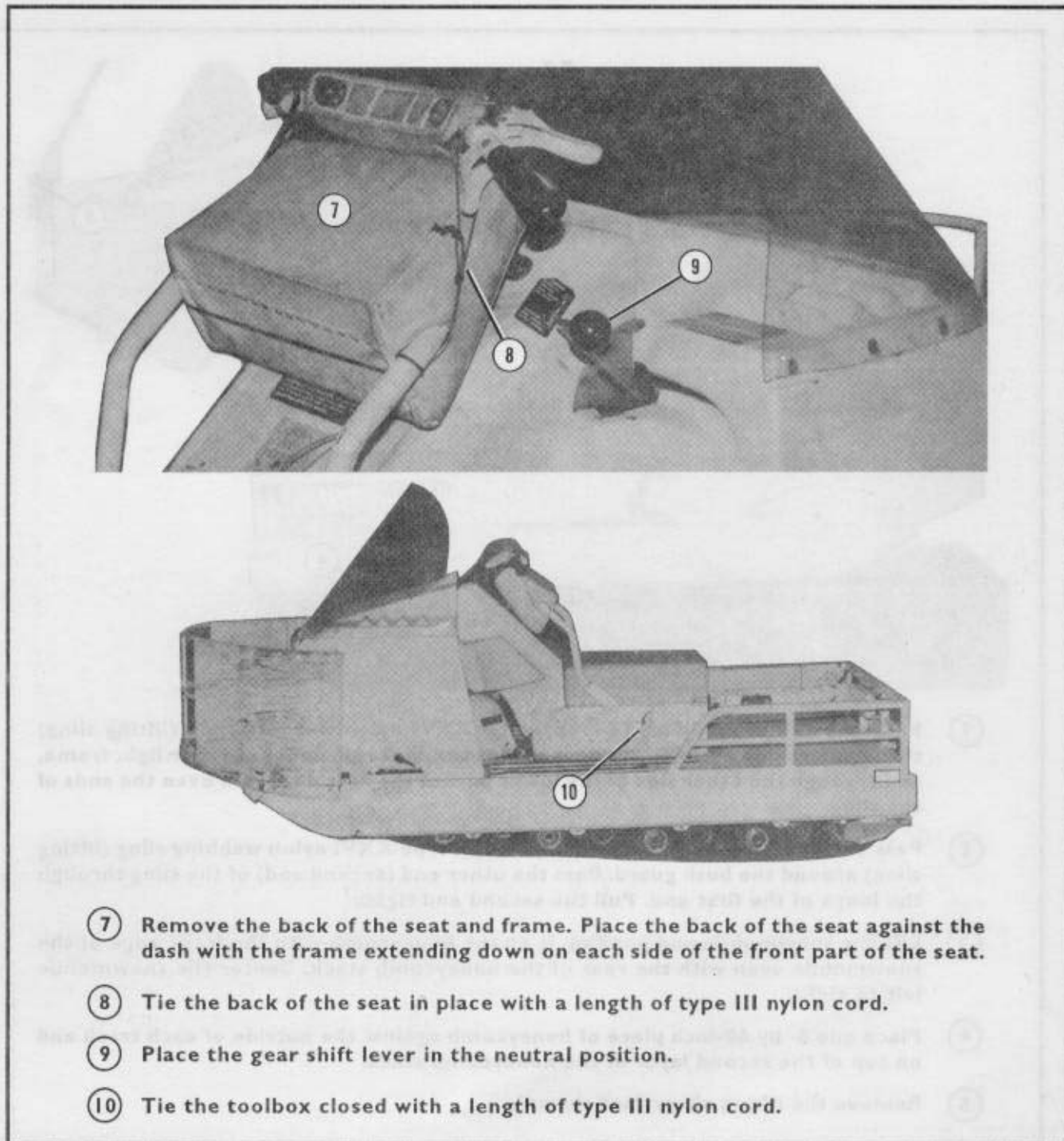
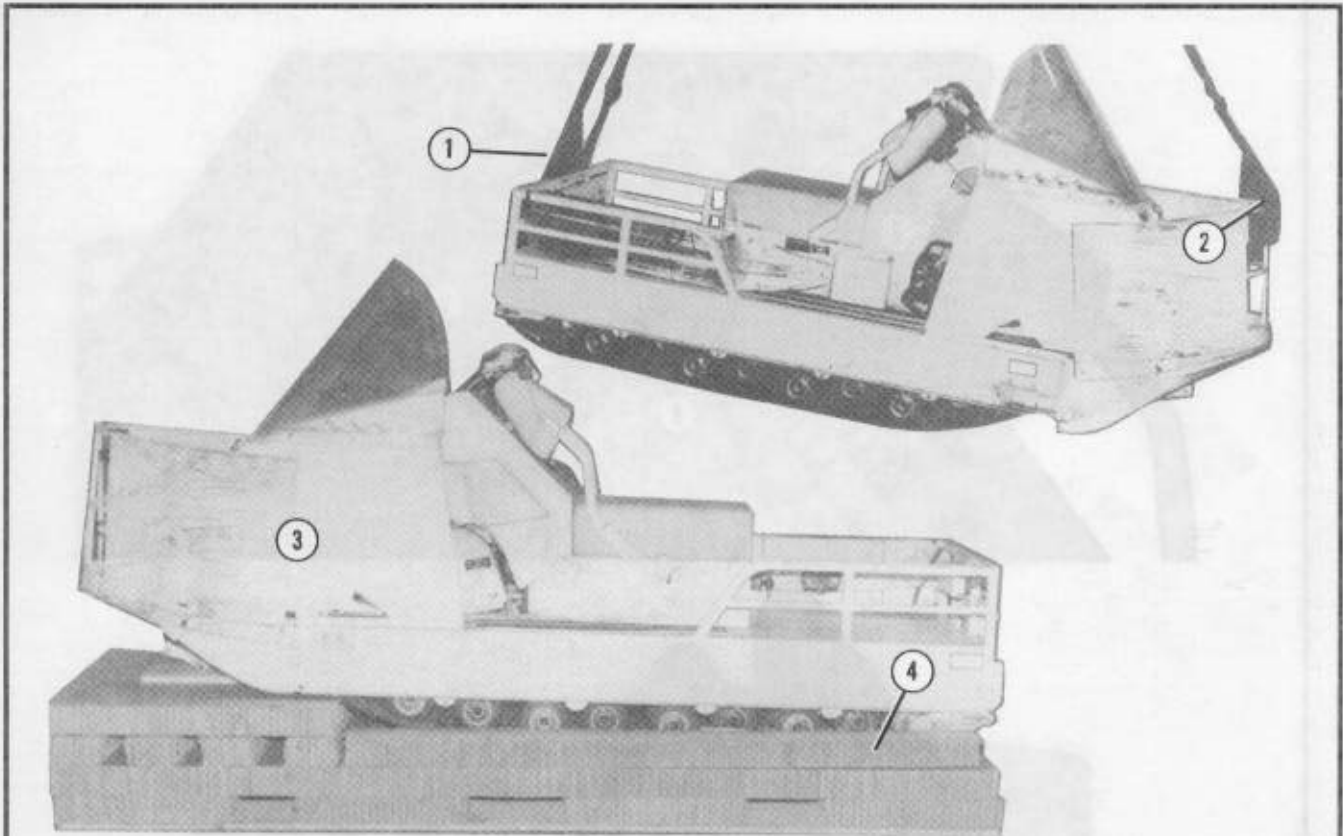

Figure 11-2. Snowmobile prepared (continued)

11-6. Positioning Load

Position the snowmobile as shown in Figure 11-3.
Position the rations as shown in Figure 11-4.



- ① Pass one end of a 16-foot (4-loop), type XXVI nylon webbing sling (lifting sling) through one side of the lower part of the rear deck rail, under the rear light frame, and through the other side of the lower part of the rear deck rail. Even the ends of the sling.
- ② Pass one end (first end) of a 9-foot (4-loop), type XXVI nylon webbing sling (lifting sling) around the bush guard. Pass the other end (second end) of the sling through the loops of the first end. Pull the second end tight.
- ③ Lift the snowmobile and position it on the honeycomb with the front edge of the snowmobile even with the rear of the honeycomb stack. Center the snowmobile left to right.
- ④ Place one 8- by 60-inch piece of honeycomb against the outside of each track and on top of the second layer of the honeycomb stack.
- ⑤ Remove the lifting slings (not shown).

Figure 11-3. Snowmobile positioned

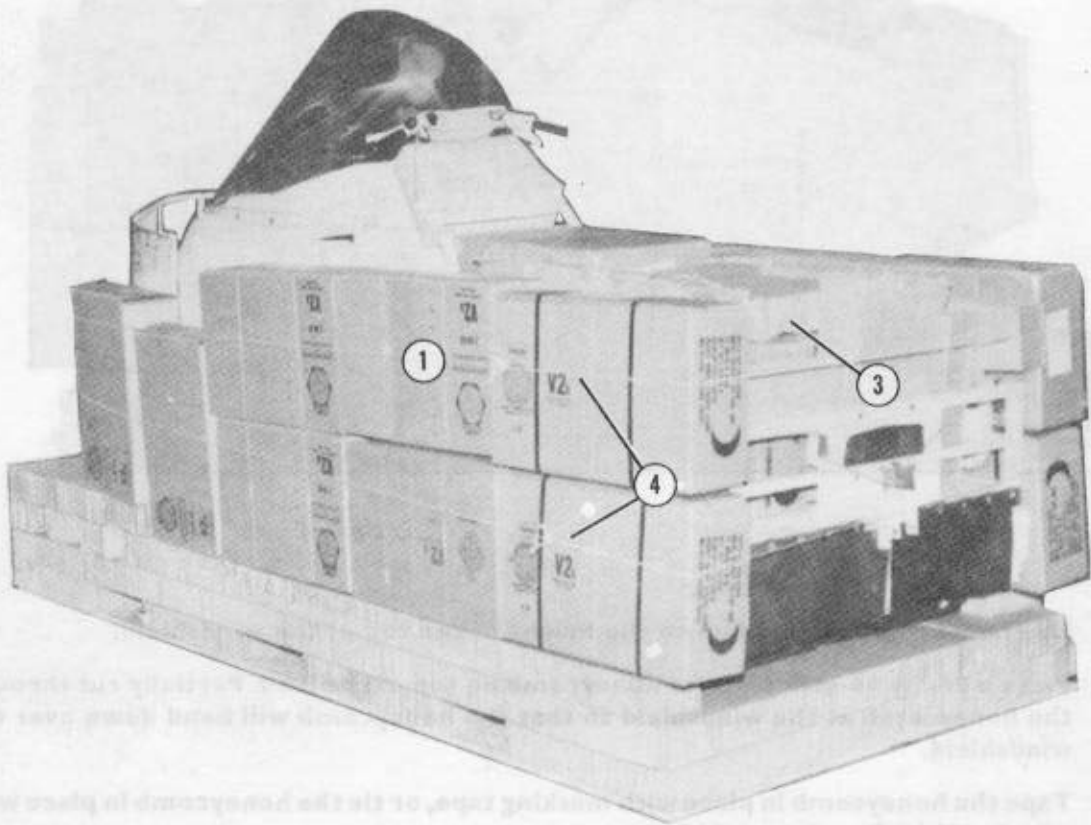

- ① Place eight cases of rations on each side of the load.
- ② Place four cases of rations (not shown) on the rear deck of the snowmobile.
- ③ Level the rear of the load with scrap honeycomb.
- ④ Tie the rations in place with two lengths of type III nylon cord.

Figure 11-4. Rations positioned

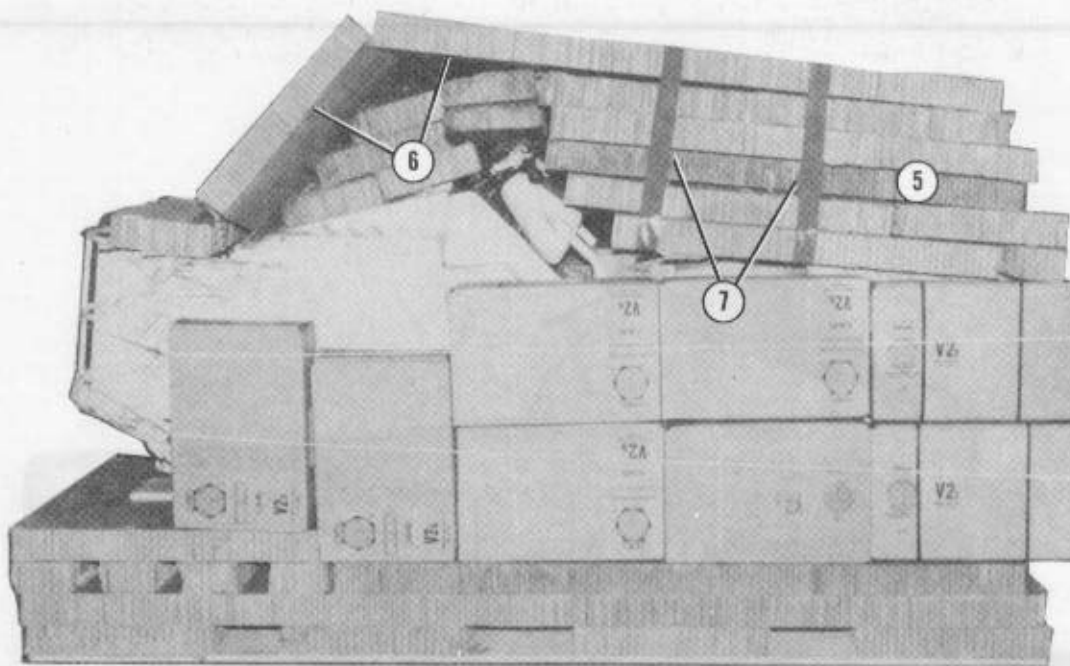

- ⑤ Use honeycomb to build up to the height of the top of the windshield.
- ⑥ Place a 36- by 96-inch piece of honeycomb on top of the load. Partially cut through the honeycomb at the windshield so that the honeycomb will bend down over the windshield.
- ⑦ Tape the honeycomb in place with masking tape, or tie the honeycomb in place with type I, 1/4-inch cotton webbing.

Figure 11-4. Rations positioned (continued)

11-7. Completing Rigged Load

Complete the rigging of the load according to paragraphs 9-25 through 9-30.

11-8. Marking Rigged Load

Mark the rigged load according to Chapter 1 using the data given in Figure 11-5. If the load varies from the one shown in Figure 11-5, recompute the data.

11-9. Equipment Required

Use the equipment listed in Table 11-1 to rig the load shown in Figure 11-5.

CAUTION

Make the final inspection required by Chapter 1 before the load leaves the rigging site. If the load includes hazardous material as defined in AFJMAN 24-204/TM 38-250, complete Shipper's Declaration for Dangerous Goods form.

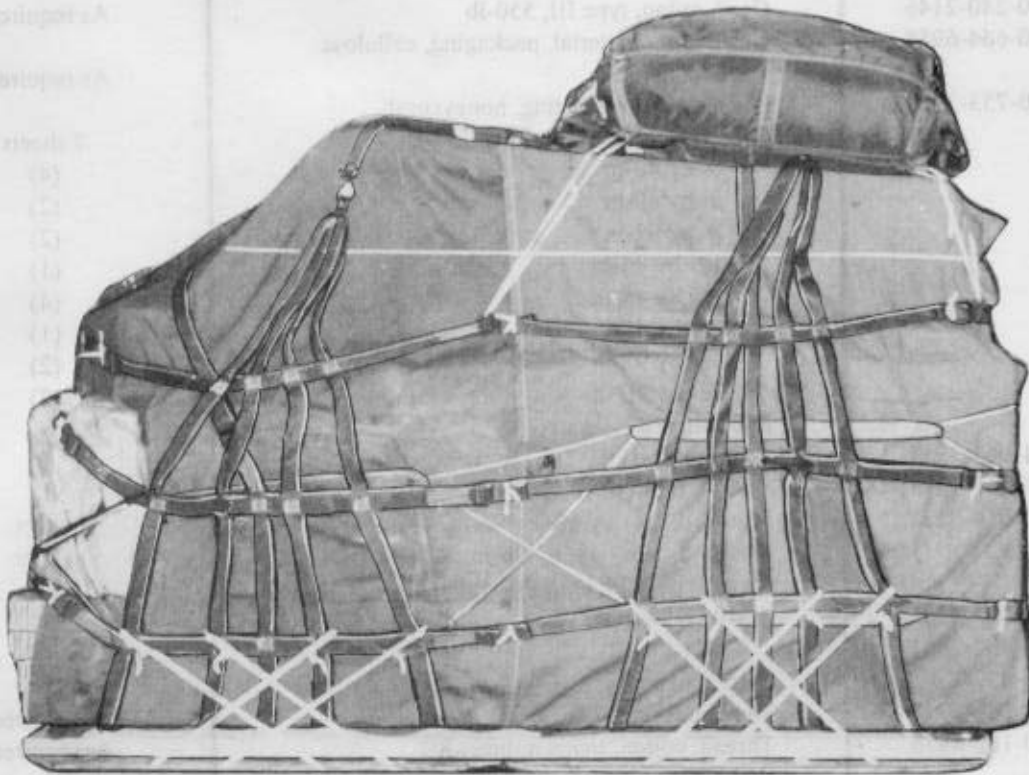
**RIGGED LOAD DATA**

Weight (with parachute)	1,654 pounds
Height (with parachute)	67 inches
Width	48 inches
Length	104 inches
Parachute	G-12E

Figure 11-5. Snowmobile rigged in a double A-22 cargo bag for low-velocity airdrop

Table 11-1. Equipment required for rigging the snowmobile in a double A-22 cargo bag for low-velocity airdrop

National Stock Number	Item	Quantity
8040-00-273-8713	Adhesive, paste, 1-gal	As required
1670-00-587-3421	Bag, cargo, A-22	2
	Clevis:	
4030-00-432-2516	Screw pin	3
4030-00-678-8562	Suspension, 3/4-in (medium)	2
4020-00-240-2146	Cord, nylon, type III, 550-lb	As required
8135-00-664-6958	Cushioning material, packaging, cellulose wadding	As required
1670-00-753-3928	Pad, energy-dissipating, honeycomb,	
	3- by 36- by 96-in:	7 sheets
	6- by 48-in	(4)
	8- by 60-in	(2)
	8- by 92-in	(2)
	12- by 96-in	(1)
	18- by 48-in	(4)
	30- by 48-in	(1)
	36- by 92-in	(2)
	36- by 96-in	(2)
	Parachute:	
1670-01-065-3755	Cargo, G-12E	1
1670-00-216-7297	Pilot, 68-in diam	1
5530-00-914-5118	Plywood, 3/4- by 48- by 96-in	1 sheet
No NSN	Plywood, 1- by 48- by 96-in	1 sheet
	Sling, type XXVI nylon webbing:	
1670-01-062-6301	3-ft (2-loop)	3
1670-00-432-2501	9-ft (4-loop)	1
1670-00-432-2505	16-ft (4-loop)	1
7510-00-266-6710	Tape, masking, 2-in	As required
8310-00-102-4478	Thread, cotton, ticket number 8/7	As required
	Webbing:	
8305-00-268-2411	Cotton, 1/4-in, type I	As required
	Nylon:	
8305-00-082-5752	Tubular, 1/2-in	As required
8305-00-263-3591	Type VIII	As required
8305-00-260-6890	Type X	As required

11-14. Marking Rigged Load

Mark the rigged load according to Chapter 1 using the data given in Figure 11-7. Each load must be computed due to varying accompanying loads. Make sure the load weighs at least 900 pounds.

11-15. Equipment Required

Use the equipment listed in Table 11-2 to rig the load shown in Figure 11-7.

CAUTION
 Make the final inspection required by Chapter 1 before the load leaves the rigging site. If the load includes hazardous material as defined in AFJMAN 24-204/TM 38-250, complete Shipper's Declaration for Dangerous Goods form.

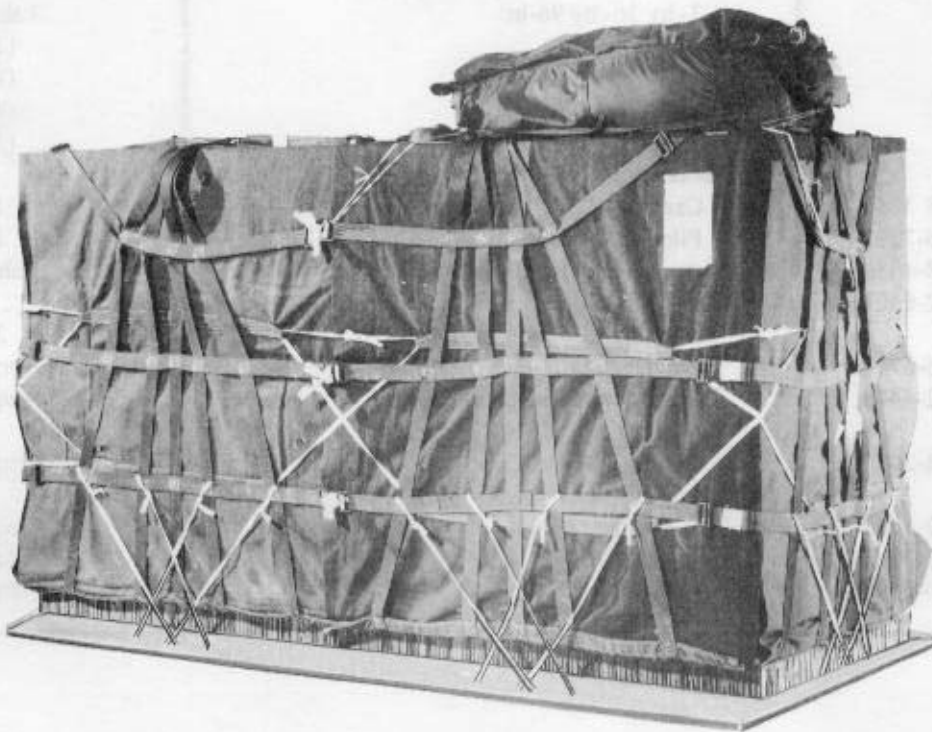

RIGGED LOAD DATA	
Weight (without parachute)	900 - 2,200 pounds
Height (with parachute)	up to 83 inches
Width	48 inches
Length	96 inches
Parachute	G-12E

Figure 11-7. Ahkio sleds rigged in a double A-22 cargo bag for low-velocity airdrop

Table 11-2. Equipment required for rigging Ahkio sleds in a double A-22 cargo bag for low-velocity airdrop

National Stock Number	Item	Quantity
8040-00-273-8713 1670-00-587-3421	Adhesive, paste, 1-gal Bag, cargo, A-22	As required 2
4030-00-432-2516	Clevis: Screw pin	3
4030-00-678-8562	Suspension, 3/4-in (medium)	2
4020-00-240-2146	Cord, nylon, type III, 550-lb	As required
8135-00-664-6958	Cushioning material, packaging, cellulose wadding	As required
1670-00-753-3928	Pad, energy-dissipating, honeycomb, 3- by 36- by 96-in: 8- by 92-in 18- by 21-in 21- by 94-in 36- by 92-in	7 sheets (2) (8) (4) (2)
1670-01-065-3755	Parachute: Cargo, G-12E	1
1670-00-216-7297	Pilot, 68-in diam	1
5530-00-128-4981	Plywood, 3/4- by 48- by 96-in	1 sheet
1670-01-062-6301	Sling, 3-ft (2-loop), type XXVI nylon webbing	3
7510-00-266-6710	Tape, masking, 2-in	As required
8310-00-102-4478	Thread, cotton, ticket number 8/7	As required
8305-00-268-2411	Webbing: Cotton, 1/4-in, type I	As required
8305-00-082-5752	Nylon: Tubular, 1/2-in	As required
8305-00-263-3591	Type VIII	As required
8305-00-260-6890	Type X	As required

PART FIVE RIGGING SPECIALIZED LOADS AND EQUIPMENT

CHAPTER 12 RIGGING A-23 CONTAINERS

12-1. Description of Load

The A-23 container load rigged for delivery by HAARS requires a modified 68-inch pilot parachute, an altitude sensor parachute staging unit, a shear strap, an A-23 cargo bag, and a G-12E cargo parachute. The A-23 cargo bag assembly is constructed similarly to an A-22 cargo bag. The only part that varies is an extra support web with D-rings on each side of the sling assembly. Figure 12-1 shows an A-23 cargo bag sling assembly. The altitude sensor unit is used to sense the altitude of the load and to cut the shear strap at the appropriate altitude. This allows the pilot parachute to be deployed which then deploys the cargo

parachute. Set the unit according to TM 10-1670-266-13&P.

a. Shear Strap. A 31-inch shear strap is used to secure the four D-rings on the additional support web. The shear strap is routed through the sensor unit and is cut during descent to allow the parachute to be deployed.

b. Retention Line. The retention line is used to keep the altitude sensor unit on the load after it activates its cutter. It is made of type XVII nylon webbing and can be ordered with the sensor of the altitude sensor unit.

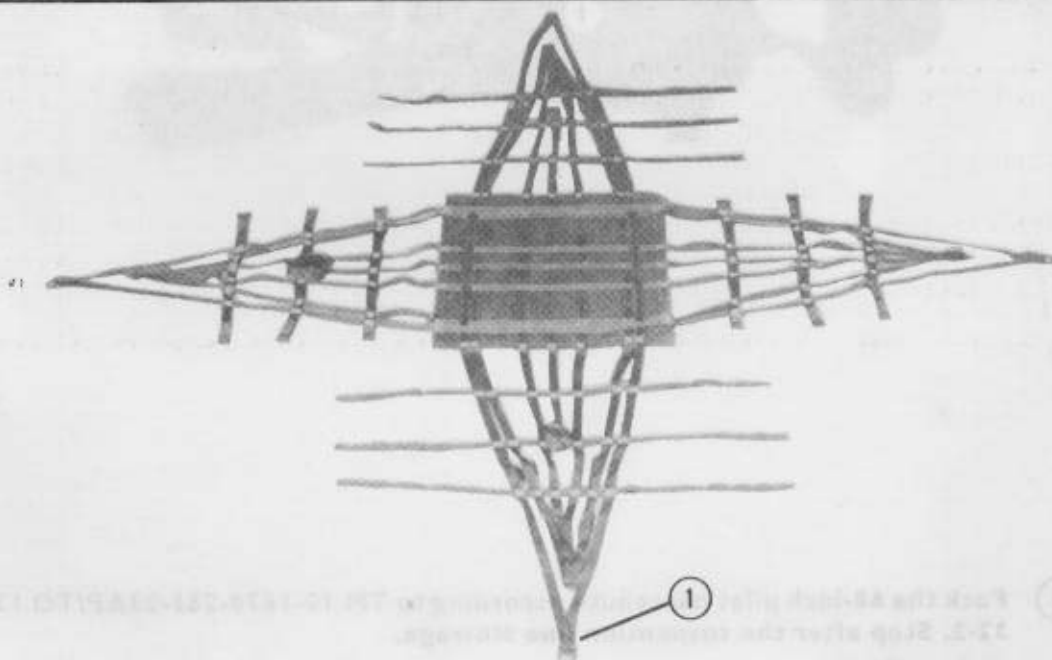

- ① The difference between the A-22 and A-23 sling assembly is the extra support web on each side. This support web is constructed of type X nylon webbing with a D-ring attached.

Figure 12-1. A-23 sling assembly

12-2. Modifying 68-Inch Pilot Parachute

Modify the 68-inch pilot parachute as shown in Figure 12-2.

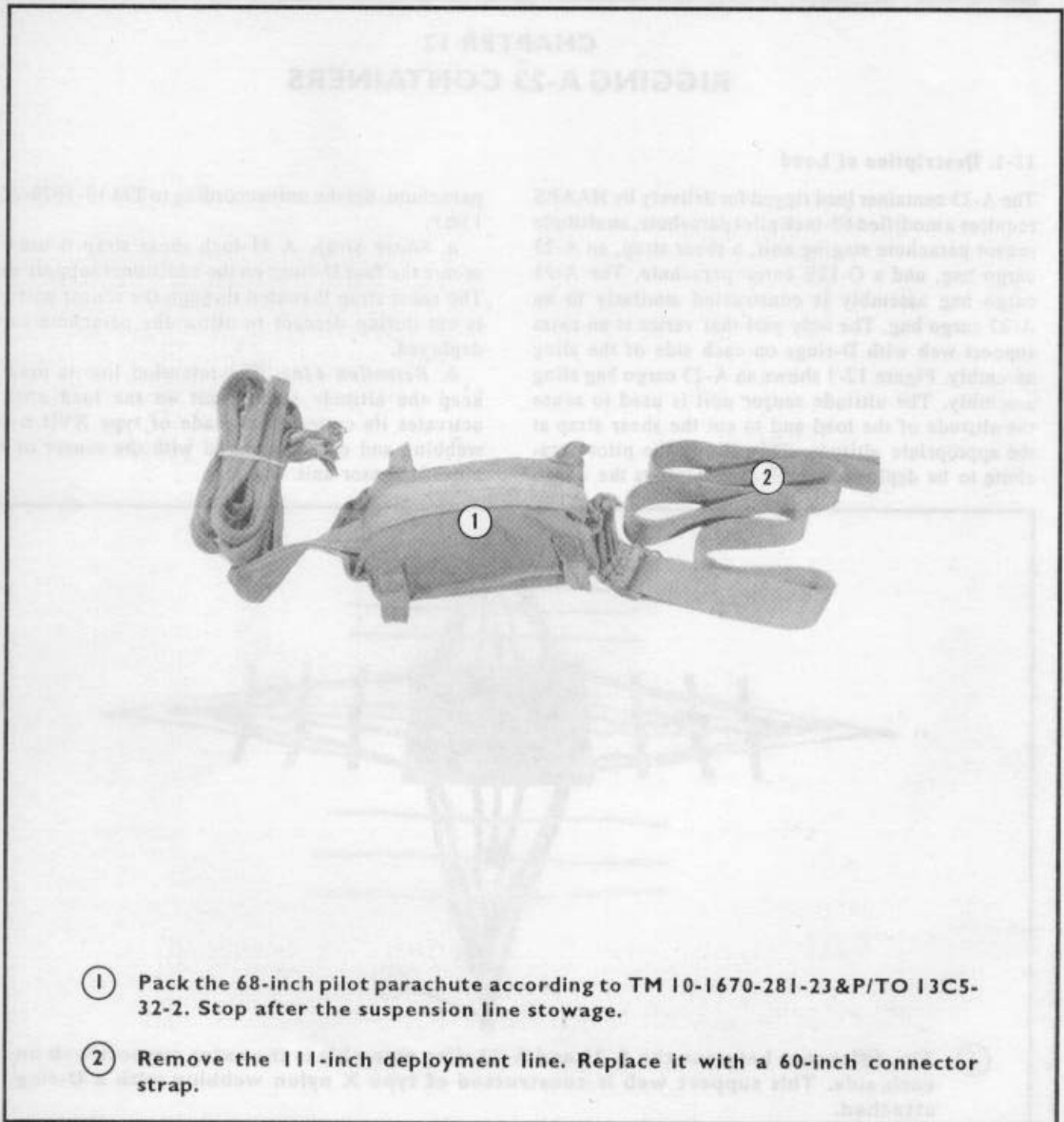
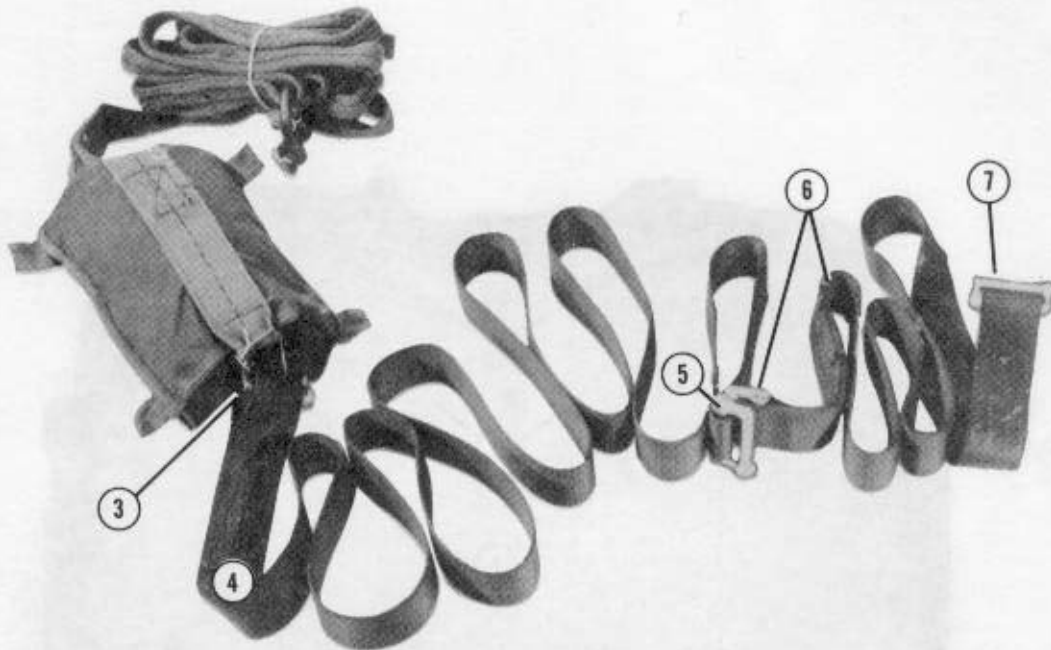

Figure 12-2. Pilot parachute modified



- ③ Attach an L-bar connector link to the end of the 60-inch connector strap and finish packing the pilot parachute.
- ④ Attach a 120-inch connector strap to the L-bar connector link on the pilot parachute.
- ⑤ Attach two L-bar connector links to the loop on the running end of the 120-inch connector strap.
- ⑥ Attach a 60-inch connector to the upper L-bar connector link on the 120-inch connector strap.
- ⑦ Attach an L-bar connector link to the running end of the 60-inch connector strap.

Figure 12-2. Pilot parachute modified (continued)

12-3. Rigging Container

Prepare and rig the load and container the same as a typical A-22 low-velocity load. Refer to paragraphs 9-3 through 9-8 for procedures. Do NOT tie skid board ties to the additional support webs and do NOT install the suspension webs.

12-4. Completing Rigged Load

Install the parachutes and altitude sensor unit as shown in Figure 12-3.

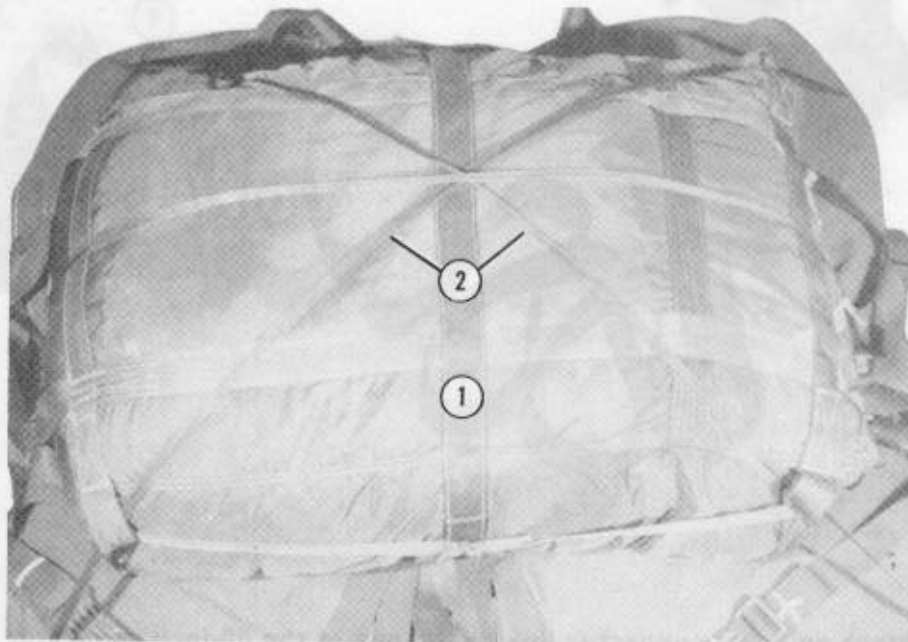

- ① Center the G-12E cargo parachute on top of the load with the riser compartment down. Attach the clevis of the G-12E cargo parachute to the D-rings on the lower support webs.
- ② Cut two lengths of 1/2-inch tubular nylon webbing. Run each length diagonally across the parachute to form an "X" and route them through the cluster attaching loops. Tie the lengths to the lateral straps on the container.

Figure 12-3. Rigged load completed

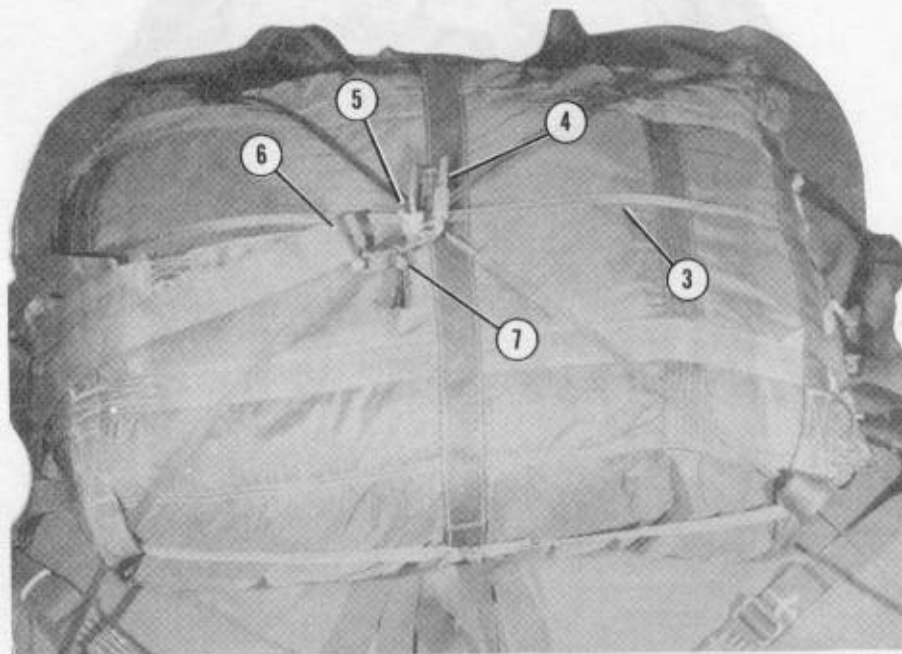

- ③ Pass a third length of 1/2-inch tubular nylon webbing across the center of the load. Tie it to the lateral straps on the load.
- ④ Fit a release knife around all three lengths of 1/2-inch tubular nylon webbing.
- ⑤ Safety tie the knife with a length of type I, 1/4-inch cotton webbing.
- ⑥ Fit the L-bar on the running end of the pilot parachute deployment line to the bridle loop of the G-12E deployment bag.
- ⑦ Use a length of 1/2-inch tubular nylon webbing to tie the release knife to the link on which the bridle loop is attached.

Figure 12-3. Rigged load completed (continued)

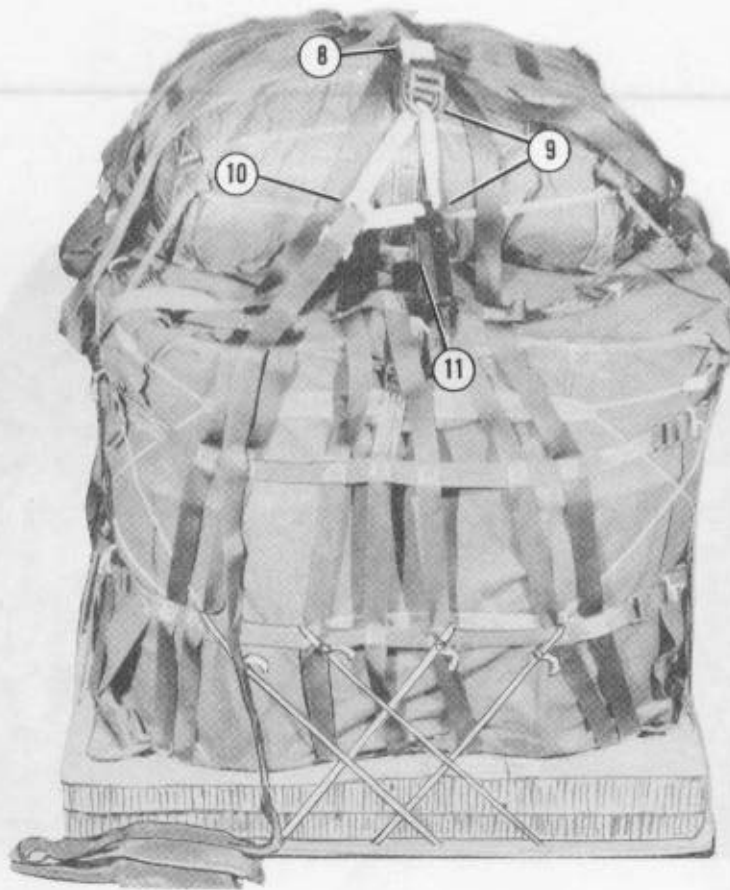

- ⑧ Bring the container upper support webs (additional support webs) to the top of the load. Tape them together with masking tape.
- ⑨ Use the shear strap to pass the single folded end through the center aperture in the altitude sensor unit and through the D-rings of the upper support webs.
- ⑩ Use the free L-bar link at the midsection of the pilot parachute deployment line to secure both running ends of the shear strap on the L-bar.
- ⑪ Install the retention line to the L-bar in step 10 and to the altitude sensor unit using an additional L-bar.

Figure 12-3. Rigged load completed (continued)



- ⑫ Tie the pilot parachute to the load with ticket number 8/7 cotton thread.

Note: The pilot parachute should be secured to the side which will face the anchor line cable.

- ⑬ Use a double length of type III nylon cord. Pass the loop end through the firing pin lanyard. Pass the running ends of the cord through the loop and secure the running ends to the container.
- ⑭ Fold and tape all excess slack in the deployment line of the pilot parachute.
- ⑮ Use a single length of type III nylon cord to tie the connector link at the mouth of the pilot parachute bag to the L-bar on which the shear strap is secured.

Figure 12-3. Rigged load completed (continued)

12-5. Marking Rigged Load

Mark the rigged load according to Chapter 1 using the data given in Figure 12-4. If the load varies from the one shown in Figure 12-4, recompute the rigged load data.

12-6. Equipment Required

Use the equipment listed in Table 12-1 to rig the load shown in Figure 12-4.

CAUTION

Make the final inspection required by Chapter 1 before the load leaves the rigging site. If the load includes hazardous material as defined in AFJMAN 24-204/TM 38-250, complete Shipper's Declaration for Dangerous Goods form.



RIGGED LOAD DATA

Weight (without parachute)	501 - 2,200 pounds
Height (with parachute)	62 inches
Width	48 inches
Length	48 inches
Parachute	G-12E

Figure 12-4. A-23 container load rigged for HAARS

Table 12-1. Equipment required for rigging an A-23 container load for HAARS

National Stock Number	Item	Quantity
1670-01-071-5022	Altitude sensor, parachute unit:	1
1377-01-064-4927	Cutter assembly	(1)
1670-01-064-4926	Sensor w retention line	(1)
1670-01-065-3748	Bag cargo, A-23 (HAARS)	1
4020-00-240-2146	Cord, nylon, type III, 550-lb	As required
1670-00-836-2231	Knife, release (guillotine)	1
1670-00-217-2421	Link assembly, link, L-bar type	5
1670-00-753-3928	Pad, energy-dissipating, honeycomb	As required
	Parachute:	
1670-01-065-3755	Cargo, G-12E (HAARS)	1
1670-00-216-7297	Pilot, 68-in diam	1
5530-00-914-5118	Plywood, 1- by 48- by 48-in	1 sheet
	or	
5530-00-128-4981	Plywood, 3/4- by 48- by 96-in (localy fabricated skid board)	1 sheet
	Strap:	
	Connector: 60-in	
1670-00-738-5878	60-in	2
1670-00-738-5879	120-in	1
1670-01-067-6533	Shear, 31-in	1
7510-00-266-6710	Tape, masking, 2-in	As required
8310-01-102-4478	Thread, cotton, ticket number 8/7	As required
	Webbing:	
8305-00-268-2411	Cotton, 1/4-in, type I	As required
8305-00-082-5752	Nylon, tubular, 1/2-in	As required

CHAPTER 13 FABRICATING AIR FORCE AIRDROP EQUIPMENT

Section I

AIR FORCE UNILATERAL TRAINING

13-1. Description of SATB

This chapter tells and shows how to make an SATB for use in unilateral training by the Air Force. The SATB is used to simulate personnel, heavy equipment, and container airdrops from a C-130 or C-141 aircraft. It consists of a sandbag filled with 13 1/2 pounds of sand or gravel and a locally made canvas bag. A 15-foot cargo extraction parachute deployment bag may be substituted for the canvas bag.

13-2. Preparing Sandbag

Fill a sandbag with 13 1/2 pounds of sand or gravel. Wrap the excess portion of the bag around the filled portion to make a compact unit. Secure the bag as shown in Figure 13-1.

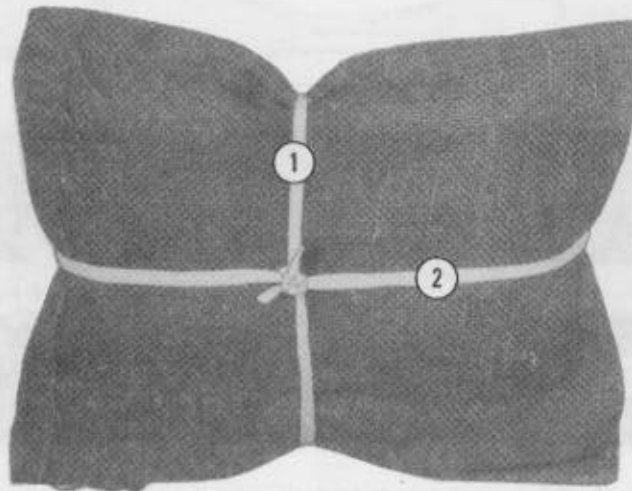

- ① Pass a length of type I, 1/4-inch cotton webbing around two sides of the bag. Pull the webbing tight, and tie the ends of the webbing together with a surgeon's knot and a locking knot.
- ② Pass a length of type I, 1/4-inch cotton webbing around the opposite sides of the bag. Pull the webbing tight, and tie the ends of the webbing together with a surgeon's knot and a locking knot.

Figure 13-1. Sandbag secured

13-3. Fabricating SATB

Make a canvas bag as shown in Figure 13-2. Sew the sandbag inside the canvas bag according to instructions in Figure 13-2.

- Notes:**
1. All dimensions are given in inches.
 2. Stitches should be sewn with size FF, olive drab nylon thread.

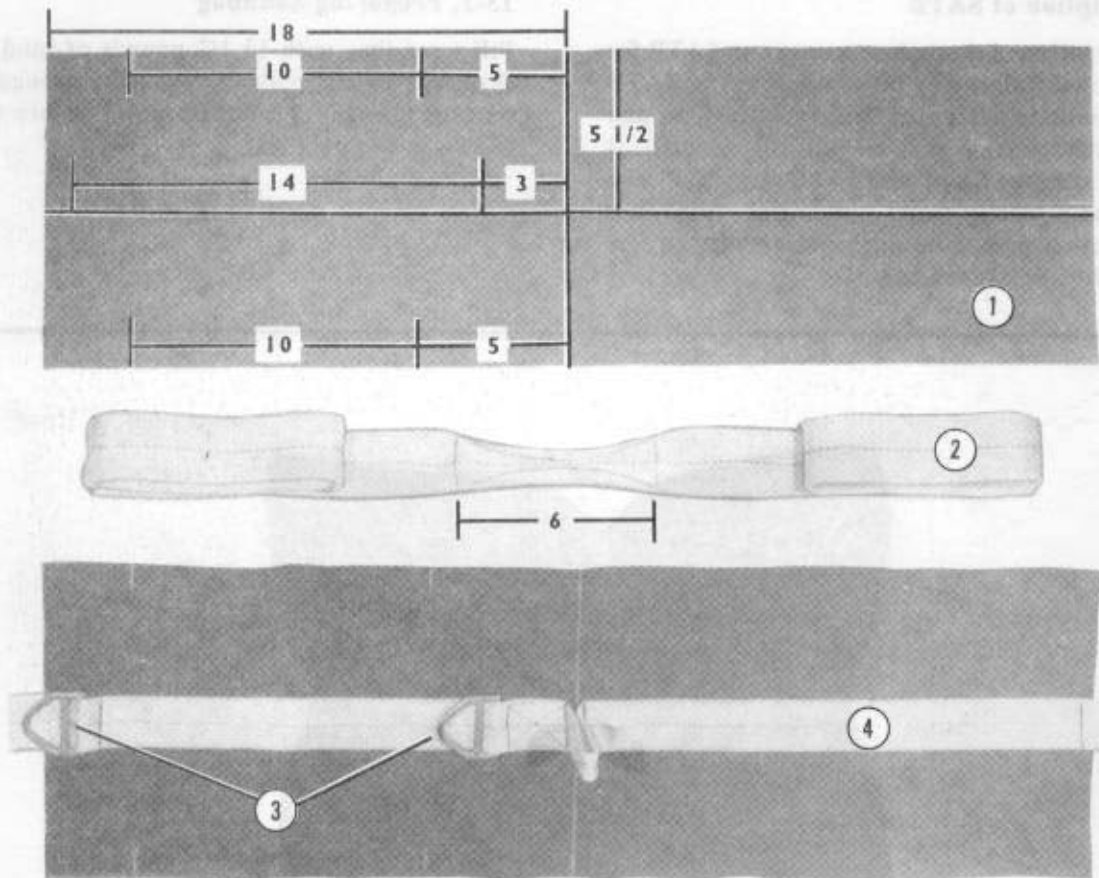

Note: The canvas (duck cloth) may be painted orange or yellow for easy identification.

- ① Make a main body strap from a 56-inch length of type VIII nylon webbing. Mark the webbing at points 25 inches from each end. Form a pendulum line attaching loop by rolling the edges between the marks and sewing the rolls in place with a lockstitch.
- ② Lay out an 11- by 36-inch piece of canvas, and mark it as shown.
- ③ Sew two V-rings to the canvas with a box stitch or a single X-box stitch as shown.
- ④ Sew the edges of the main body strap to the canvas as shown.

Figure 13-2. SATB fabricated

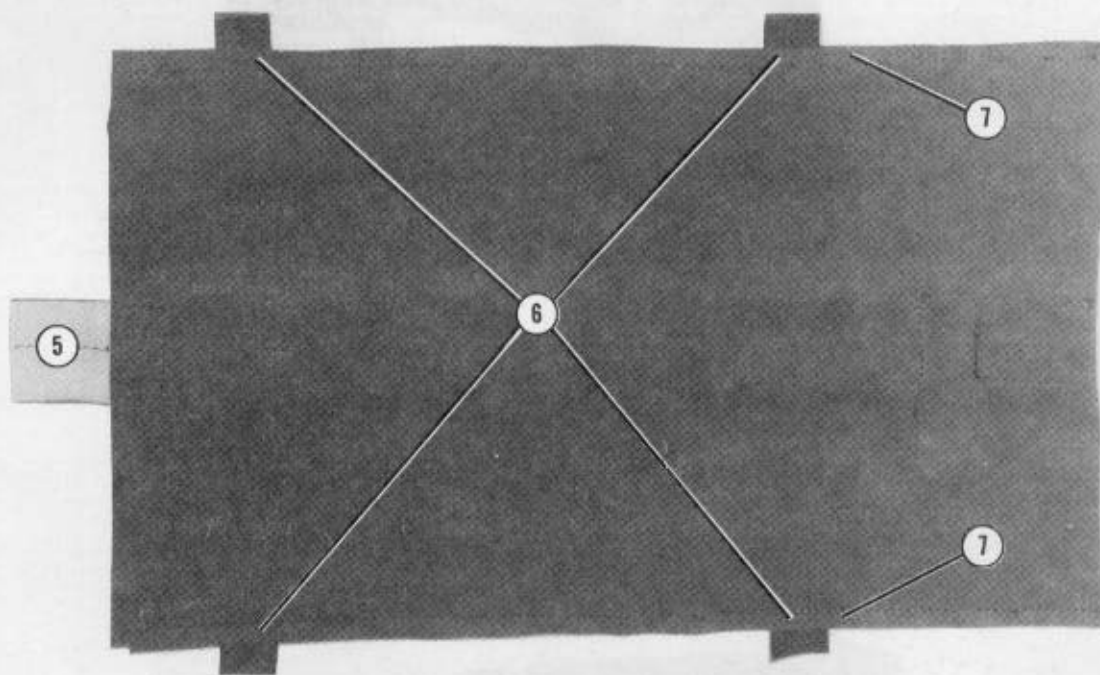

- ⑤ Fold the canvas in half lengthwise with the main body strap on the inside.
- ⑥ Make tie tabs by cutting four 4-inch lengths of type IV, 1-inch nylon webbing. Fold the webbing in half lengthwise, and mark each piece 1 inch from the folded end.
- ⑦ Start sewing the two long outside seams with a double row of locking stitches. Sew the tie tabs to the canvas by inserting the folded end of the tie tabs inward on the 10-inch marks (step 2).

Figure 13-2. SATB fabricated (continued)

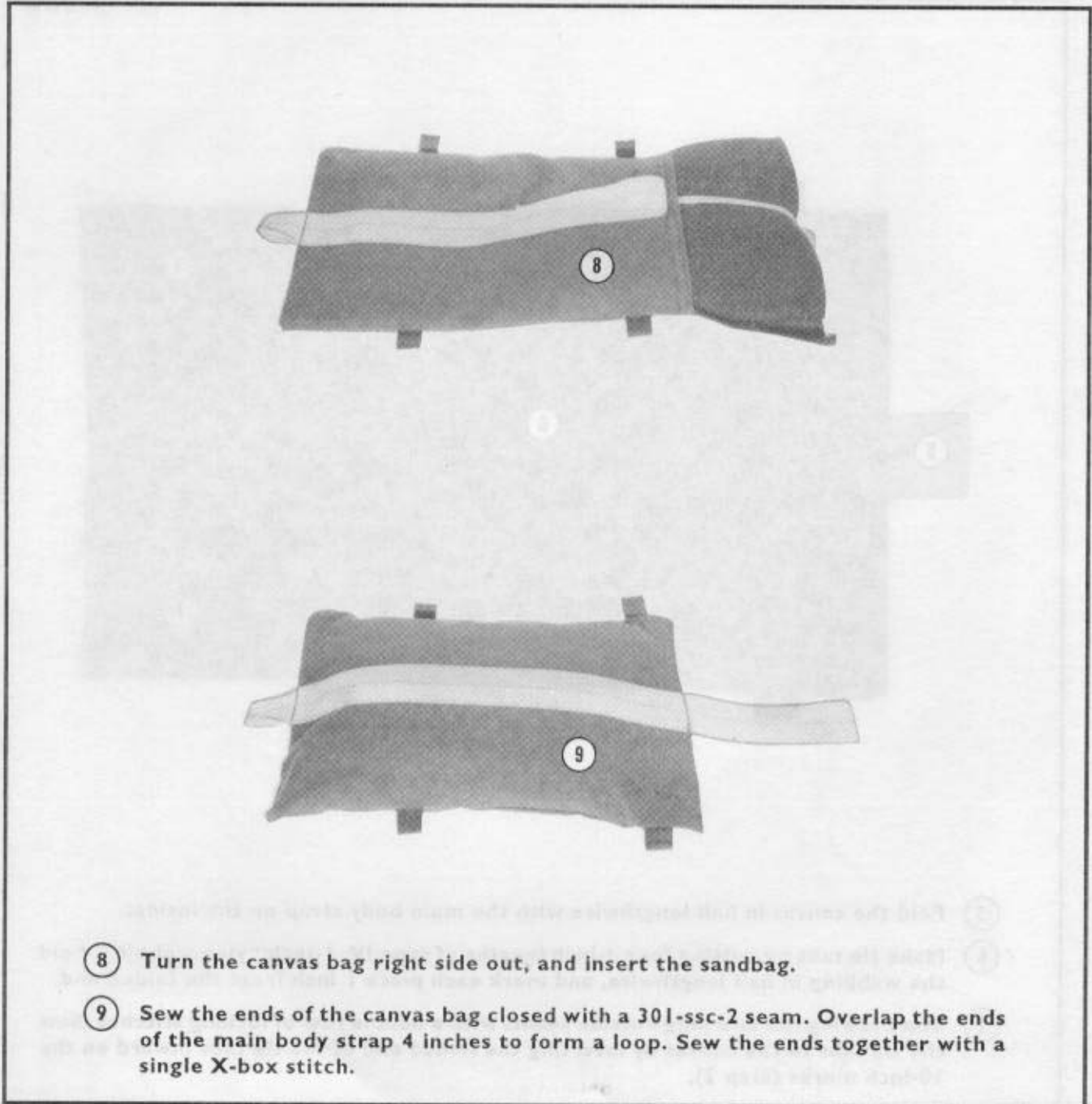

- ⑧ Turn the canvas bag right side out, and insert the sandbag.
- ⑨ Sew the ends of the canvas bag closed with a 301-ssc-2 seam. Overlap the ends of the main body strap 4 inches to form a loop. Sew the ends together with a single X-box stitch.

Figure 13-2. SATB fabricated (continued)

13-4. Attaching Pendulum Line

Attach an 85-inch, type IV coreless nylon cord pendulum line to the pendulum line attaching loop of the SATB as shown in Figure 13-3.

NOTE: When the load is dropped from a C-130 aircraft, a 40-inch pendulum line may be used.

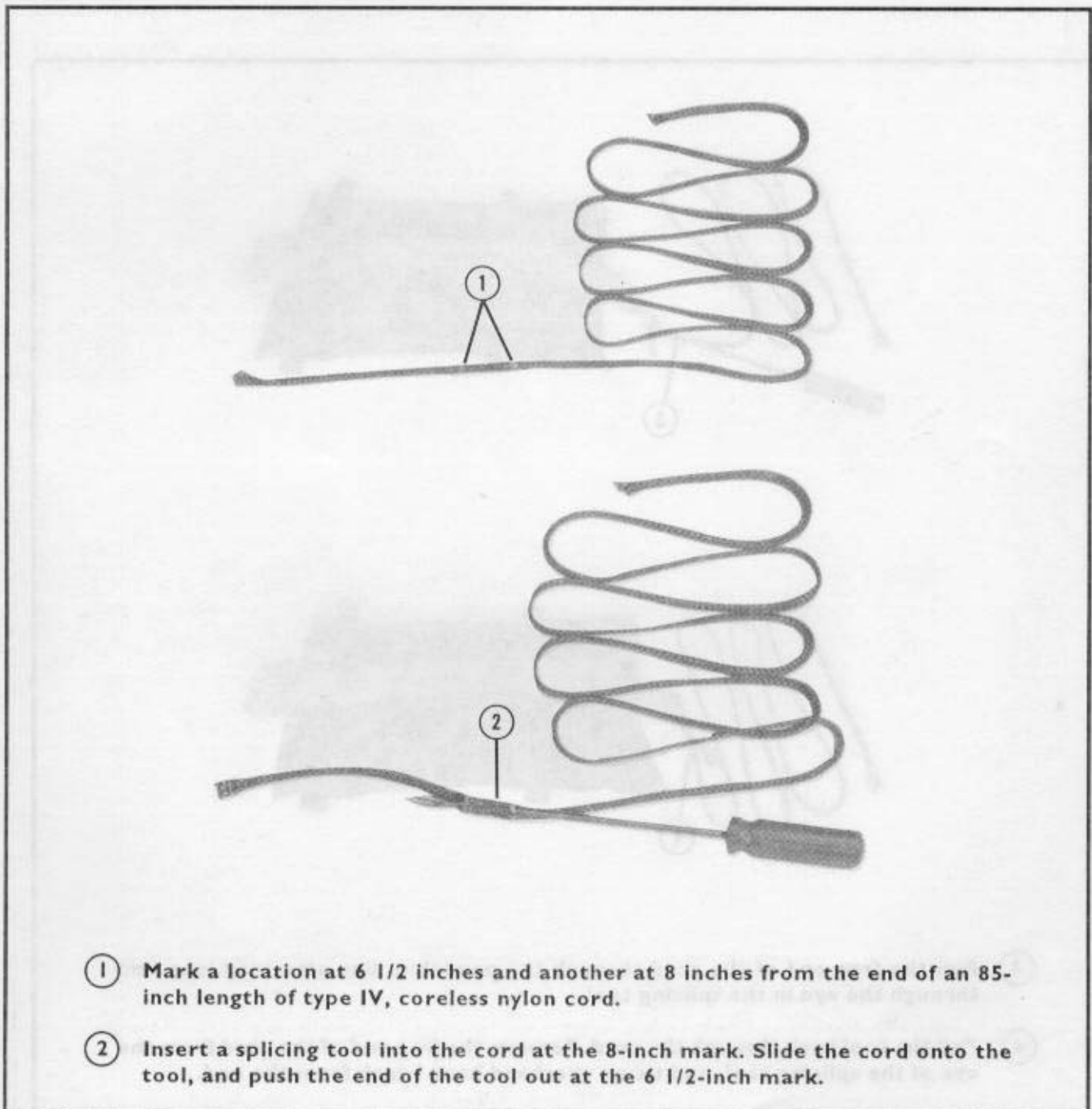
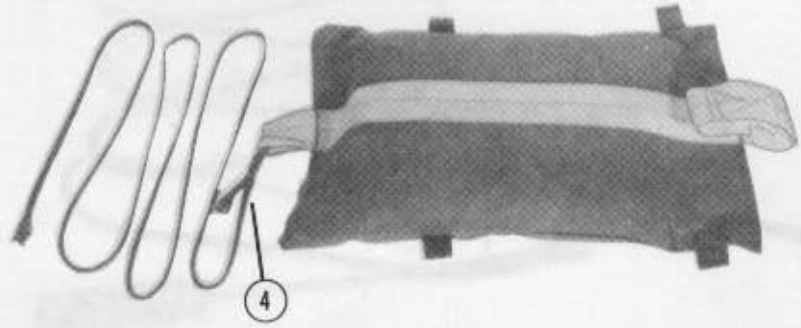
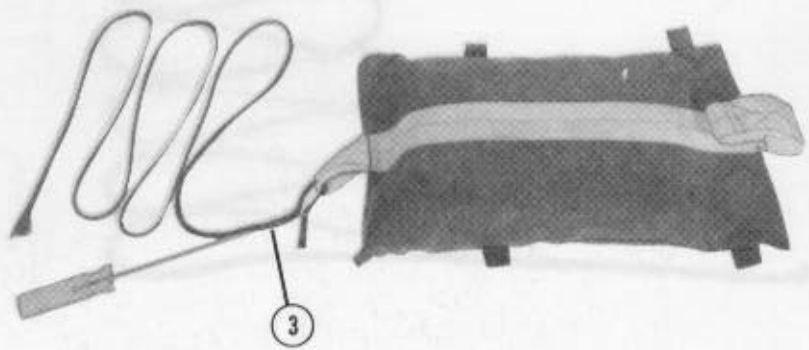

Figure 13-3. Pendulum attached to SATB

NOTE: When the tool is inserted into a C-119, attach a 40-inch pendulum line to the tool.

13-6 Attaching Pendulum Line
 Attach a 40-inch type IV pendulum line to the tool. Run the line to the pendulum line attaching loop on the tool. Attach the line to the pendulum line attaching loop on the tool.



- ③ Run the free end of the cord through the pendulum line attaching loop and through the eye in the splicing tool.
- ④ Pull the tool back through the cord. Remove the free end of the cord from the eye of the splicing tool, and tie an overhand knot 1 inch from the end.

Figure 13-3. Pendulum attached to SATB (continued)

13-5. Packing and Installing Pilot Parachute

Pack a 68-inch pilot parachute as outlined in TM 10-1670-281-23&P/TO 13C5-32-2, but make the apex and bag-closing ties with single lengths of ticket number 8/4 cotton thread. Install the pilot parachute on the SATB as shown in Figure 13-4.

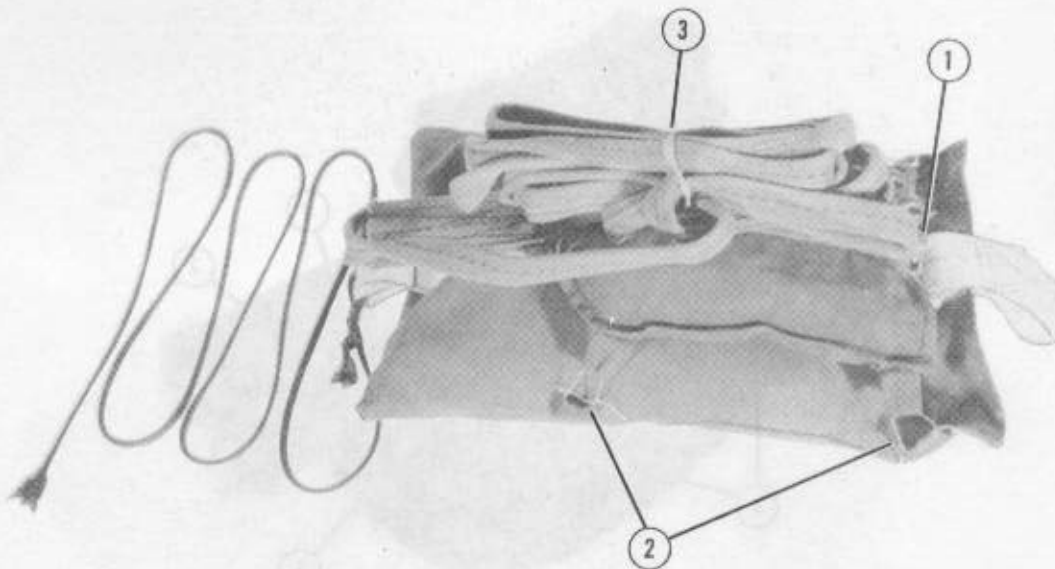

- ① Attach the pilot parachute deployment line to the deployment line attaching loop of the SATB with a connector link.
- ② Tie the pilot parachute to the SATB with single ties of ticket number 8/4 cotton thread.
- ③ Fold the static line, and secure the folds with a retainer band.

Figure 13-4. Pilot parachute installed on SATB

13-6. Attaching Marker Light

For night operations, tie a distress marker light or chemical light to a tie tab with a double length of type I, 1/4-inch cotton webbing.

13-7. Using Extraction Parachute Deployment Bag

If a 15-foot cargo extraction parachute deployment bag is substituted for the canvas bag used to enclose the sandbag, prepare the SATB as described below.

a. Place the filled sandbag in the deployment bag, and tie the deployment bag closed.

b. Safety a 68-inch pilot parachute to the deployment bag as shown in Figure 13-5.

13-8. Equipment Required

Use the equipment listed in Table 13-1 to rig the SATB.



- ① Tie the deployment bag closed with ties of type III nylon cord.
- ② Attach the pilot parachute deployment line to both closing loops on the grommet side with the deployment line connector link.
- ③ Tie the pilot parachute bag closed with a single length of ticket number 8/4 cotton thread.
- ④ Tie the pilot parachute bag to the extraction parachute deployment bag with four ties. Make each tie using a single length of ticket number 8/4 cotton thread.

Figure 13-5. Pilot parachute tied to deployment bag

Table 13-1. Equipment required for rigging an SATB

National Stock Number	Item	Quantity
1670-00-815-2727	Bag, deployment, 15-ft, cargo parachute	1
1670-00-568-0323	Band, rubber, retainer	1
8305-00-242-3593	Cloth, cotton duck, 60-in	As required
	Cord, nylon:	
4020-00-262-2020	Braided, type IV	As required
4020-00-240-2146	Type III, 550-lb	As required
1670-00-217-2421	Link assembly, L-bar type	1
1670-00-216-7297	Parachute, pilot, 68-in diam	1
8105-00-285-4744	Sandbag	1
8310-00-102-4477	Thread, cotton, ticket number 8/4	As required
1670-00-360-0471	V-ring	2
	Webbing:	
8305-00-268-2411	Cotton, 1/4-in, type I	As required
	Nylon:	
8305-00-268-2455	Tubular, 1-in	As required
8305-00-263-3591	Type VIII	As required

Section II

FABRICATION OF C-130 CDS PULLEY STRAP

13-9. Description of C-130 CDS Pulley Strap

This section tells and shows how to make a 1-inch tubular nylon webbing CDS pulley strap for use in C-130 aircraft. CDS pulley straps are used to suspend a pulley overhead in the aircraft to release the gate.

13-10. Preparing C-130 CDS Pulley Strap

Prepare a 1-inch tubular nylon webbing CDS pulley strap, in lengths as specified in TO 1C-130A9, as shown in Figure 13-6.

- Notes:**
1. All stitching will be 1/8 inch from sides or spaced 1/8 inch apart unless otherwise specified.
 2. A 1/2-inch lock stitch must be made.
 3. Size 3 thread, type 301 stitch with five to seven stitches per inch must be used.
 4. All exposed ends of nylon webbing must be fused. Make sure no sharp edges are formed.

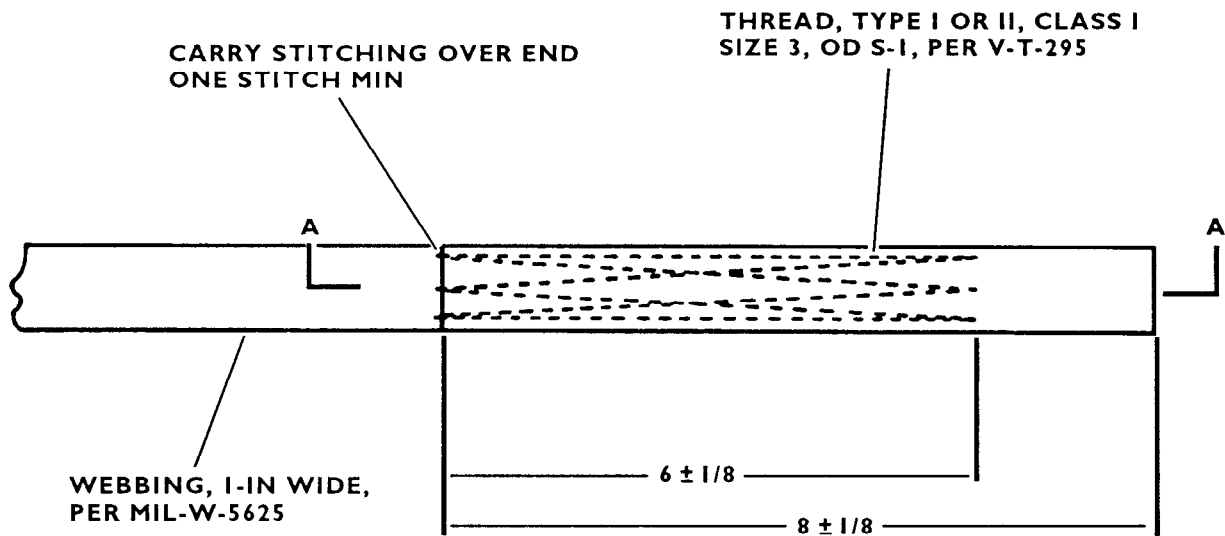

Figure 13-6. C-130 CDS pulley strap prepared

GLOSSARY

AFB	Air Force base	ft	foot/feet
AFJMAN	Air Force joint manual	gal	gallon
AFR	Air Force regulation	GLLD	ground laser location designator
AFTO	Air Force technical order	HAARS	high-altitude airdrop resupply system
AMC	Air Mobility Command	HQ	headquarters
AR	Army regulation	in	inch
ATCF	air traffic control facility	lb	pound
attn	attention	MCRP	Marine Corps reference publication
CDS	container delivery system	no	number
CVRS	centerline vertical restraint system	POP	performance-oriented packaging
d	penny	SATB	standard airdrop training bundle
DA	Department of the Army	TM	technical manual
DD	Department of Defense	TO	technical order
diam	diameter	TRADOC	United States Army Training and Doctrine Command
FM	field manual	US	United States
FMFM	fleet Marine force manual	w	with

REFERENCES

These documents must be available to the intended users of this publication.

AFR 55-40/AR 59-4. Joint Airdrop Inspection Records, Malfunction Investigations, and Activity Reporting. 27 November 1984.

*AFJMAN 24-204/TM 38-250. Preparing Hazardous Materials for Military Air Shipments. 25 November 1994.

FM 10-500-2/TO 13C7-1-5. Airdrop of Supplies and Equipment: Rigging Airdrop Platforms. 1 November 1990.

FM 10-516/TO 13C7-1-13. Airdrop of Supplies and Equipment: Reference Data for Airdrop Platform Loads. 31 October 1983.

FM 10-538/TO 13C7-1-18. Airdrop of Supplies and Equipment: Rigging Naval Emergency Air Cargo Delivery System (NEACDS). 6 August 1982.

FM 10-550/TO 13C7-22-71. Airdrop of Supplies and Equipment: Rigging Stinger Weapon Systems and Missiles. 29 May 1984.

**FM 10-500-53/TO 13C7-18-41/MCRP 4-3.8. Airdrop of Supplies and Equipment: Rigging Ammunition. 1 March 1996.

***FM 10-500-9. Tactics, Techniques, and Procedures for Quartermaster Airdrop and Airdrop Support Units. 3 October 1995.

TM 10-1670-201-23/TO 13C-1-41. Organizational and Direct Support Maintenance for General Maintenance of Parachutes and Other Airdrop Equipment. 30 Oct 73.

TM 10-1670-265-12&P/TO 13C7-1-21. Operator's and Organizational Maintenance Manual Including Repair Parts and Special Tools for High Altitude Airdrop Resupply System: 2,200 Pound Capacity. 28 October 1982.

TM 10-1670-266-13&P. Operator's, Organizational and Direct Support Maintenance Manual Including Repair Parts and Special Tools List for Altitude Sensor Parachute Staging Unit (ASPSU) Test Set, FLT 4240. 30 January 1984.

TM 10-1670-267-12&P/TO 13C7-1-101. Operator's and Organizational Maintenance Manual Including Repair Parts and Special Tools List for High Altitude Airdrop Resupply System: 500 Pound Capacity. 29 August 1984.

*AFJMAN 24-204/TM 38-250 has superseded AFR 71-4/TM 38-250 (15 January 1988). Change 1 reflects this change. The basic manual still references the superseded publication. You may wish to make pen and ink changes to update the old reference citations accordingly.

**FM 10-500-53/TO 13C7-18-41/MCRP 4-3.8 has superseded FM 10-553/TO 13C7-18-41 (4 December 1981). Change 1 reflects this change. The basic manual still references the superseded publication. You may wish to make pen and ink changes to update the old reference citation accordingly.

***FM 10-500-9 has superseded TM 10-500-9/TO 13C7-1-9 (25 March 1966). Change 1 reflects this change. The basic manual still references the superseded publication. You may wish to make pen and ink changes to update the old reference citations accordingly.

TM 10-1670-275-23&P/TO 13C5-25-2. Unit and Intermediate Direct Support (DS) Maintenance Manual (Including Repair Parts and Special Tools List) for Parachute, Cargo Type: 12-Foot Diameter, High-Velocity Cargo Parachute. 17 March 1989.

TM 10-1670-276-23&P/TO 13C5-29-2. Unit and Intermediate Direct Support (DS) Maintenance Manual (Including Repair Parts and Special Tools List) for Parachute, Cargo Type: 26-Foot Diameter, High-Velocity Cargo Parachute. 28 September 1990.

TM 10-1670-278-23&P/TO 13C5-26-2. Unit and Intermediate Direct Support (DS) Maintenance Manual (Including Repair Parts and Special Tools List) for Parachute, Cargo Type: 15-Foot Diameter, Cargo Extraction Parachute. 6 November 1989.

TM 10-1670-279-23&P/TO 13C5-27-2. Unit and Intermediate Direct Support Maintenance Manual (Including Repair Parts and Special Tools List) for Parachute, Cargo Type: 22-Foot Diameter, Cargo Extraction Parachute. 30 August 1989.

TM 10-1670-281-23&P/TO 13C5-32-2. Unit and Intermediate Direct Support (DS) Maintenance Manual (Including Repair Parts and Special Tools List) for Parachute, Cargo Type: 64-Foot Diameter, Model G-12D and Model G-12E. 12 October 1990.

TM 10-1670-282-23&P/TO 13C5-30-2. Unit and Direct Support (DS) Maintenance Manual (Including Repair Parts and Special Tools List) for Parachute, Cargo Type: 34-Foot Diameter, Model G-14 Low-Velocity Cargo Parachute. 10 September 1991.

TM 10-1670-293-23&P/TD 14D1-2-467-2. Unit and Intermediate Direct Support (DS) Maintenance Manual (Including Repair Parts and Special Tools List) for Parachute, Personnel Type: 35-Foot Diameter, T-10C Troop Back Parachute Assembly. 23 September 1988.

*TM 10-1670-298-20&P. Unit Maintenance Manual (Including Repair Parts and Special Tools List): Container Delivery System. 15 September 1995.

TM 55-1520-210-10. Operator's Manual for UH-1H/V Helicopters. 15 February 1988.

TM 55-1520-237-10. Operator's Manual for UH-60A and EH-60A Helicopters. 8 January 1988.

TM 55-1520-240-10. Operator's Manual for CH-47D Helicopter. 10 November 1982.

TO 1C-130A9. The Cargo Loading Manual. 16 June 1980.

AFTO Form 22. Technical Order Publications Improvement Report. April 1973.

DA Form 2028. Recommended Changes to Publications and Blank Forms. February 1974.

**Shipper's Declaration for Dangerous Goods. Locally Procured Form.

***DD Form 1748-1. Joint Airdrop Inspection Record (Container). January 1995.

*TM 10-1670-298-20&P has superseded TM 10-1670-240-20/TO 13C7-49-11 (April 1970). Change 1 reflects this change. The basic manual still references the superseded publication. You may wish to make pen and ink changes to update the old reference citation accordingly.

**Shipper's Declaration for Dangerous Goods has superseded DD Form 1387-2 (February 1982). Change 1 reflects this change. The basic manual still references the superseded publication. You may wish to make pen and ink changes to update the old reference citations accordingly.

***DD Form 1748-1 has superseded DD Form 1748-4 (January 1984). Change 1 reflects this change. The basic manual still references the superseded publication. You may wish to make pen and ink changes to update the old reference citations accordingly.